

# **v100NX**

**105 cm Ku-Ka Convertible  
Maritime VSAT Antenna System**

**Installation & Operation User Guide**



## Serial number of the product

This serial number will be required for all troubleshooting or service inquiries.

# Intellian

© 2019 Intellian Technologies, Inc. All rights reserved. Intellian and the Intellian logo are trademarks of Intellian Technologies, Inc., registered in the U.S. and other countries. The v100NX is a trademark of Intellian Technologies, Inc. Intellian may have patents, patent applications, trademarks, copyrights, or other intellectual property rights covering subject matter in this document. Except as expressly provided in any written license agreement from Intellian, the furnishing of this document does not give you any license to these patents, trademarks, copyrights, or other intellectual property. All other logos, trademarks, and registered trademarks are the property of their respective owners. Information in this document is subject to change without notice. Every effort has been made to ensure that the information in this guide is accurate. Intellian is not responsible for printing or clerical errors.

### Disclaimer

The information in this user guide is subject to change without prior notice through a product life cycle. A printed version of the guide is periodically updated and may contain inaccuracies or omissions compared to the recent product information. The most up-to-date information can be readily accessible on our website at <http://www.Intelliantech.com>.

# Table of contents

## ***Precautions***

|                               |   |
|-------------------------------|---|
| Warnings, Cautions, and Notes | 8 |
| General Precautions           | 8 |

## ***Certifications***

|                |    |
|----------------|----|
| Certifications | 10 |
|----------------|----|

## ***Introduction***

|                               |    |
|-------------------------------|----|
| Intellian v100NX Introduction | 12 |
| Intellian v100NX Features     | 13 |
| Antenna Unit                  | 14 |
| Antenna Control Unit (ACU)    | 15 |

## ***Planning Installation***

|   |    |
|---|----|
| ACU Box (Including Components Kit)        | 16 |
| Antenna Specification                     | 17 |
| Antenna Dimensions                        | 17 |
| Heading Alignment                         | 18 |
| Mast Designing (Installation Example)     | 19 |
| Option 2. When Placing Cable Outside Mast | 20 |
| Antenna Mounting Hole Pattern             | 21 |
| Preparing Installation                    | 22 |
| Selection of Installation Site            | 22 |
| Minimize Satellite Blockage               | 22 |
| Avoid RF Interference                     | 23 |
| RF Hazard Precautions                     | 23 |
| Preparing System Cables                   | 24 |
| Placing Cable on Mast                     | 25 |

## ***Installing Antenna***

|   |    |
|---|----|
| Antenna Installation                    | 26 |
| Unpacking Wooden Crate                  | 26 |
| Removing Antenna from Wooden Crate      | 28 |
| Placing Antenna on Mast                 | 29 |
| Attaching Waterproof Foam               | 30 |
| Mounting Radome                         | 31 |
| Connecting RF Cable (Customer Supplied) | 32 |
| Switching On Power Box                  | 33 |

## ***Installing ACU***

|   |           |
|---|-----------|
| <b>Selection of ACU Installation Site</b> .....                       | <b>34</b> |
| <b>ACU Dimensions</b> .....   | <b>34</b> |
| <b>Mounting ACU</b> .....   | <b>35</b> |
| 19" Rack Mount Type.....  | 35        |
| <b>System Configurations</b> .....                                    | <b>36</b> |
| Single Antenna System Configuration (Basic Antenna System).....       | 36        |
| Dual Antenna System Configuration (Optional).....                     | 37        |
| <b>ACU Cable Connection</b> .....                                     | <b>38</b> |
| Name of ACU Rear Panel.....   | 38        |
| Connecting to the Antenna.....  | 38        |
| Connecting to Antenna (Optional: For Dual Antenna System).....        | 39        |
| Connecting to Modem.....  | 39        |
| Connecting to Additional ACU (Optional: For Dual Antenna System)..... | 40        |
| Connecting to Switch Router.....                                      | 40        |
| Connecting Ship's Gyrocompass.....                                    | 41        |
| How to Connect NMEA 0183 Gyrocompass Cable.....                       | 41        |
| <b>ACU Connector Pinouts Guide</b> .....                              | <b>42</b> |
| Console Connector (Modem Interface).....                              | 42        |
| RS232/RS422 Connector (Modem Interface).....                          | 42        |
| RS232 Connector (PC Interface).....                                   | 43        |
| RS232/RS422 Connector (BUC Interface).....                            | 43        |
| NMEA 2000 Connector.....  | 44        |
| LAN 1~4 Ports.....  | 44        |
| <b>ACU to PC Communication Setup</b> .....                            | <b>45</b> |
| TCP/IP Connection.....  | 45        |
| Wi-Fi Connection.....   | 46        |

## ***Operating Install Wizard***

|   |           |
|---|-----------|
| <b>Turning On System</b> .....              | <b>47</b> |
| <b>Accessing AptusNX</b> .....              | <b>47</b> |
| <b>Setting up Modem Configuration</b> ..... | <b>48</b> |
| <b>Starting Install Wizard</b> .....        | <b>50</b> |

## ***Operating ACU***

|                                 |           |
|---------------------------------|-----------|
| <b>Introduction</b> .....       | <b>59</b> |
| Antenna Control Unit (ACU)..... | 59        |
| ACU Front Panel.....            | 59        |
| ACU Display Menu.....           | 60        |
| <b>Startup</b> .....            | <b>61</b> |
| <b>Diagnosis</b> .....          | <b>63</b> |

|                              |           |
|------------------------------|-----------|
| <b>Antenna Information</b>   | <b>65</b> |
| <b>Interface Information</b> | <b>66</b> |
| <b>USB Function</b>          | <b>67</b> |

## **Using AptusNX**

|  |           |
|--|-----------|
| <b>Introduction</b>                                  | <b>72</b> |
| How to access AptusNX for ACU                        | 72        |
| <b>Main Page</b>                                     | <b>73</b> |
| Page Login   | 73        |
| <b>Top Menus</b>                                     | <b>74</b> |
| <b>Account Menu</b>                                  | <b>75</b> |
| Account  | 75        |
| Registration   | 76        |
| System   | 77        |
| User Manager   | 78        |
| <b>Dashboard</b>                                     | <b>79</b> |
| How to Add & Remove Panels (Dashboard Setting)       | 79        |
| How to Arrange Dashboard Layout                      | 80        |
| How to Use Shortcut Settings                         | 81        |
| <b>Install Wizard</b>                                | <b>81</b> |
| <b>System Tools</b>                                  | <b>82</b> |
| Firmware Upgrade                                     | 82        |
| iARM Upgrade   | 84        |
| iARM Save & Reboot                                   | 85        |
| Satellite Library                                    | 86        |
| Spectrum Graph                                       | 87        |
| Graph  | 88        |
| <b>System Troubleshooting</b>                        | <b>89</b> |
| Diagnosis  | 89        |
| Antenna Log  | 91        |
| Antenna Event Log                                    | 92        |
| Support  | 92        |
| <b>System Setting</b>                                | <b>93</b> |
| Ship Setting   | 93        |
| Antenna Setting                                      | 95        |
| Tracking Satellite Setting                           | 98        |
| Network Configuration                                | 99        |
| Modem/BUC Setting                                    | 101       |
| SNMP Setting   | 104       |
| Backup & Restore Setting                             | 105       |
| Mediator Setting (Optional: For Dual Antenna System) | 106       |

## **Specification**

**Technical Specification**.....108  
**Environmental Specification**.....109

***Warranty***

**Warranty Policy**.....110



***Appendix A***

**Starting Dual Antenna System (Optional)**.....A-1

# Precautions





## Warnings, Cautions, and Notes

WARNING, CAUTION, and NOTE statements are used throughout this manual to emphasize important and critical information. You must read these statements to help ensure safety and to prevent product damage. The statements are defined below.

|   |  |
|---|--|
| <br><b>WARNING</b> | <p><b>WARNING</b></p> <p>WARNING indicates a potentially hazardous situation which, if not avoided, could result in death or serious injury.</p>   |
| <br><b>CAUTION</b> | <p><b>CAUTION</b></p> <p>CAUTION indicates a potentially hazardous situation which, if not avoided, could result in minor or moderate injury. It may also be used to alert against unsafe practices.</p> |
| <br><b>NOTE</b>    | <p><b>NOTE</b></p> <p>A NOTE statement is used to notify people of installation, operation, programming, or maintenance information that is important, but not hazard-related.</p>                       |

## General Precautions

Before you use the antenna, make sure that you have read and understood all safety requirements.

|  |  |
|--|--|
| <br><b>THIS WAY UP</b>  | <ul style="list-style-type: none"> <li>Place the boxes/crates on the floor with the arrow pointing up.</li> </ul>  |
| <br><b>FRAGILE</b>      | <ul style="list-style-type: none"> <li>Since the Radome is fragile, handle it with care. Do not apply excessive pressure or shock. These may cause surface cracking or other damage.</li> </ul>  |
| <br><b>DO NOT STACK</b> | <ul style="list-style-type: none"> <li>Do not stack boxes/crates as there is a risk boxes/crates may fall and be damaged.</li> </ul>   |
| <br><b>KEEP DRY</b>     | <ul style="list-style-type: none"> <li>Always make sure the antenna is stored on a dried floor.</li> <li>The antenna can withstand ordinary rain. However its water resistance cannot be guaranteed if submerged.</li> <li>Keep the antenna in a dried place for sufficient ventilation. Do not store the antenna wrapped in a tarp, tent, vinyl, and others.</li> </ul> |

\* **DO NOT SHIP VIA RAIL:** Ensure not to ship any system via Rail.





# Certifications

## Certifications

### FCC Declaration of Conformity

Intellian Technologies, manufactures of stabilized maritime VSAT antenna systems for satellite communication at sea, supplies stabilized maritime VSAT antenna systems to the satellite communication service providers for their ESV (Earth Station on Vessels) networks.

FCC §25.222 defines the provisions for blanket licensing of ESV antennas operation in the Ku-band. It defines the antennas radiation, and each article regulates the followings;

- §25.222 (a)(1)(i)(A): Regulation for Azimuth Direction & Co Polarization
- §25.222 (a)(2)(i)(B): Regulation for Other Direction & Co Polarization
- §25.222 (a)(1)(i)(C): Regulation for Cross Polarization

Intellian Technologies, Inc. declares that v100NX complies with the threshold level as defined in §25.222(a)(1)(i)(A);, and declares that v100NX is in accordance with all defined regulations from §25.222(a)(1)(i)(B) to §25.222(a)(1)(i)(C) at the below stated input power spectral density, with an N value of 1.

|                             |  |
|-----------------------------|--|
| Product description         | Intellian v100NX, 105cm Ku-band maritime VSAT antenna system |
| EIRP spectral density limit | -14.00 dBW/ 4KHz   |

Intellian Technologies, Inc. declares that the above antenna will maintain a pointing error of less than or equal to 0.2 degree under specified ship motion conditions in accordance with the requirements of §25.222 (a)(1)(ii).

Intellian Technologies, Inc. declares that the above antennas will automatically cease the transmission with a mute command to the modem within 100 milliseconds if the target satellite and the axis of the main lobe of the ESV antenna exceeds 0.5 degree and will not resume until such angle is less than or equal to 0.2 degree in accordance with the requirements of §25.222 (a)(1)(iii)

Radiation pattern data is available upon request to verify the conformance.

**Authority:** Kevin Eom  
/ CTO, R&D

**Signature:**  \_\_\_\_\_



**Date:** \_\_\_\_\_ April 16, 2019

**Intellian Technologies, Inc.**  
US Headquarters  
11 Studebaker  
Irvine, CA 92618 USA  
Tel: +1 949 727 4498

**Intellian Technologies, Inc.**  
EMEA & APAC Headquarters  
5F IDIS Tower, 344, Pangyo-ro (Sampyeong-dong),  
Bundang-gu, Seongnam-si, Gyeonggi-do 13493 Korea  
Tel: +82 2 511 2244

## RED Declaration of Conformity (DoC)

We, Intellian Technologies, Inc. located at 18-7, Jinwisandan-ro, Jinwi-myeon, Pyeongtaek-si, Gyeonggi-do 17709, Korea declare under our sole responsibility that the product(s) described in the below to which this declaration relates is in conformity with the *essential requirements* and *other relevant requirements* of the Radio Equipment Directive (2014/53/EU).

Product Information:

|                         |   |
|-------------------------|---|
| <b>Product Name(s):</b> | Intellian v100NX, 1m Ku-band Maritime VSAT Antenna System<br>Intellian v85NX, 85cm Ku-band Maritime VSAT Antenna System |
|-------------------------|---|

To provide the presumption of conformity in accordance to Annex III(encompassing Annex II) of Directive 2014/53/EU; the following harmonized standards and normative documents are those to which the product’s conformance is declared, and by specific reference to the essential requirements of Article 3 of the Directive 2014/53/EU.

| 2014/53/EU Article  | Standard(s) Applied in Full                               | Result |
|---------------------|---|--------|
| SAFETY (Art 3.1.a)  | EN 60950-1:2006 + A11:2009 + A1:2010 + A12:2011 + A2:2013 | Pass   |
| EMC (Art. 3.1.b)    | EN 301 843-1 v2.1.1                                       | Pass   |
| SPECRTUM (Art. 3.2) | EN 302 340 v2.1.1   | Pass   |

Supplementary Information:

|   |  |
|---|--|
| <b>Notified Body Involved:<br/>(Testing Organization)</b> | DT&C Co., Ltd.<br>42, Yurim-ro, 154 beon-gil, Cheoin-gu, Yongin-si, Gyeonggi-do 17042, Korea               |
| <b>Technical/Compliance File<br/>Held by:</b>             | Intellian Technologies, Inc.<br>18-7, Jinwisandan-ro, Jinwi-myeon, Pyeongtaek-di, Gyeonggi-do 17709, Korea |
| <b>Place and Date of issue:</b>                           | Gyeonggi-do, Korea on 31 Jan. 2018   |

**Authority:**        **Kevin Eom**  
                              / **CTO, R&D**

**Signature:** \_\_\_\_\_ 

**Date:** \_\_\_\_\_ **January 11, 2019**

**Intellian Technologies USA, Inc.**  
US Headquarters  
11 Studebaker  
Irvine, CA 92618 USA  
Tel: +1 949 727 4498

**Intellian Technologies, Inc.**  
EMEA & APAC Headquarters  
348-5 Chungo-Ri, Jinwi-Myeon  
Pyeongtaek-Si, Gyeonggi-Do, 451-862 Korea  
Tel: +82 31 379 1000

Doc Number IT19-DC0418-01

# Introduction

## Intellian v100NX Introduction

Intellian v100NX is a Ku-band 3-axis stabilized VSAT maritime antenna system. The v100NX provides advanced VSAT solutions for Ku-band satellite services that are also designed to be convertible to Ka-band network. v100NX is equipped with a new mounting architecture RF module.

The antenna's 3-axis stabilized platform and advanced shock-resistant and vibration damping design of the Pedestal is fully optimized to withstand the demanding maritime conditions and to ensure reliable broadband communications.

The v100NX is even more operator-friendly in that it combines TX, RX and DC power into one cable, simplifying installation. With the new radome design, the dome-on external single cable connection means that installers do not need to remove the radome during installation either.

Equipped with Intellian's next generation Antenna Control Software, "AptusNX", the v100NX antenna can be easily accessed, monitored and controlled. This new simply configured tool can alert an operator to possible problems with its enhanced diagnostic capabilities and can also provide automatic alerts when preventative maintenance may be required.

The v100NX is supplied with both cross-pol and co-pol feeds and comes equipped with Intellian's patent pending Global PLL LNB by standard.

## Intellian v100NX Features

### Higher RF Performance

Intellian's highly efficient RF design delivers superior performance compared to other 1 meter class systems, enabling higher data rates and global operation. The v100NX has improved tracking precision and reliability in a compact and streamlined mechanical design. The v100NX system is supplied as standard with 8 W BUC, or can be supplied with 16 W and 25 W variants.

### Future Proof Communications

The v100NX can be simply upgraded from Ku- to Ka-band operation by changing the center mounted RF Assembly and Feed using an available conversion kit. Frequency tuned reflector and radome ensure maximum performance across both Ku- and Ka-bands.

### Single Coaxial Cable

Combined Tx, Rx and DC power in a Single Cable solution, the v100NX enables faster and reduced costs of installation. Dynamic Motor Brakes, eliminating the requirement of shipping brackets, and Dome-On external RF cable connection on the base allow easier and quicker installation without removing the radome.

### Embedded Dual Antenna Mediator function

Intellian's new ACU fully supports dual antenna operation without additional hardware such as a separate mediator, RF splitters and cables. Eliminate loss of signal due to blockage by using dual antenna systems.

### Standardized Modular Components Across NX Series

Modular components are used throughout the NX range, such as dynamically braked motors with integrated encoders, Main Control Unit and skew assembly. Sharing common modules across Intellian's NX antenna series, the number of spare parts is reduced by more than 30%.

### AptusNX Intelligent Diagnosis

Intellian's all new integrated M&C software, enables advanced alerts from the live data monitoring and analysis agent, the v100NX sends warning messages to the NOC in advance when it detects any abnormal operation. Intuitive web application interface is designed to provide a superior user experience. AptusNX enhances remote diagnosis, automates routine processes and includes an integrated spectrum analyzer. The AptusNX API enables integration directly within an NOC for total fleet-wide visibility.

## Antenna Unit

The antenna unit includes an antenna pedestal inside a radome assembly unit. The pedestal consists of a satellite antenna main dish with RF components mounted on a stabilized pedestal. The radome protects the antenna pedestal assembly unit from the severe marine environment.



*Figure: Radome & Antenna Unit*

## Antenna Control Unit (ACU)

Antenna Control Unit (ACU) controls Antenna system operation. The following functions are supported by ACU.

- High power supply for the high power BUC
- Mediator function included
- Spectrum analyzer function included
- OLED display
- USB Log download & Firmware upgrade (No PC required)
- Wi-Fi access
- AptusNX Web application

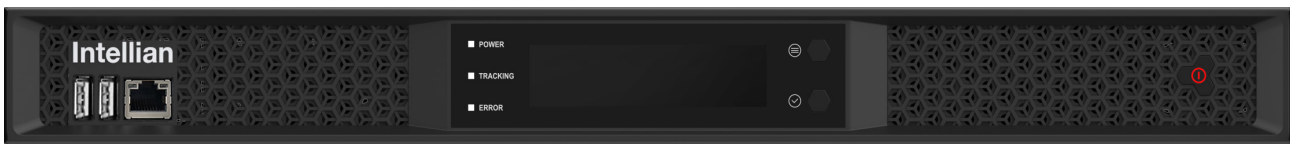

Figure: Front Panel of ACU



Figure: Rear Panel of ACU

# Planning Installation

## ACU Box (Including Components Kit)

Before beginning installation, make sure you have all the included components.

| Description                                  | Q'ty | Size                      | Remarks   |
|--|------|---------------------------|---|
| Antenna Control Unit (ACU)                   | 1    | 431 mm x 350 mm x 44.3 mm | Antenna Control Unit (ACU)  |
| Quick Installation Guide (QIG)               | 1    |                           |   |
| RF Hazard Sticker                            | 1    |                           | Radiation Safety Distance (15 m) Label                                |
| Mounting Template                            | 1    |                           |   |
| ACU Rack Mount Bracket                       | 2    |                           | To fix ACU to 19inch Rack Frame                                       |
| Flat Head Screw                              | 10   | M4 x 12 L                 | Bolt Kit for Rack Type Mount Bracket                                  |
| USB Cable (A-A)                              | 1    | 1.8 m                     | ACU (Front Panel) to PC   |
| AC Power Cord (CEEE7/7)                      | 1    | 1.5 m                     | ACU Power (220 V)   |
| RG-6 RF Cable                                | 2    | 1 m                       | ACU to Modem  |
| Modem Interface Cable<br>(For iDirect Modem) | 1    | 1.5 m                     | ACU to Modem (iDirect Modem)  |
| Ethernet Cable (RJ45/LAN)                    | 2    | 1 m                       | ACU to PC/Intellian M&C   |
| Wi-Fi Dongle                                 | 1    |                           |   |
| Hex Bolt (BUMAX)                             | 5    | M12 x 80 L                | Bolt Kit for Antenna - Deck (Mast)<br>Assembly (1 spare set included) |
| Flat Washer                                  | 5    | M12                       |   |
| Spring Washer                                | 5    | M12                       |   |
| Hex Head Wrench Bolt                         | 5    | M6 x 40 L                 | Spare Bolt Kit for Radome Assembly                                    |
| Spring Washer and Flat Washer                | 5    | M6                        |   |
| Sems Bolt                                    | 2    | M4 x 8 L                  |   |
| Radome Door Key                              | 2    |                           | Two Door Keys   |
| Waterproof Foam                              | 1    |                           | X-shape Cable Hole Type   |



## Antenna Specification

### Antenna Dimensions

Confirm the height and diameter of the bottom surface of the antenna unit before installing it. The mounting surface and overall space occupied by the antenna must be sufficient for the height and diameter of the fully constructed radome on top of its base frame. The height and the diameter of the bottom surface of the antenna are as shown in the following drawing. It is strongly suggested that the installation is conducted using a crane.



*Figure: Antenna Dimensions*

## Heading Alignment

The radome assembly should be positioned with the BOW marker aligned as close as possible to the center line of the ship.

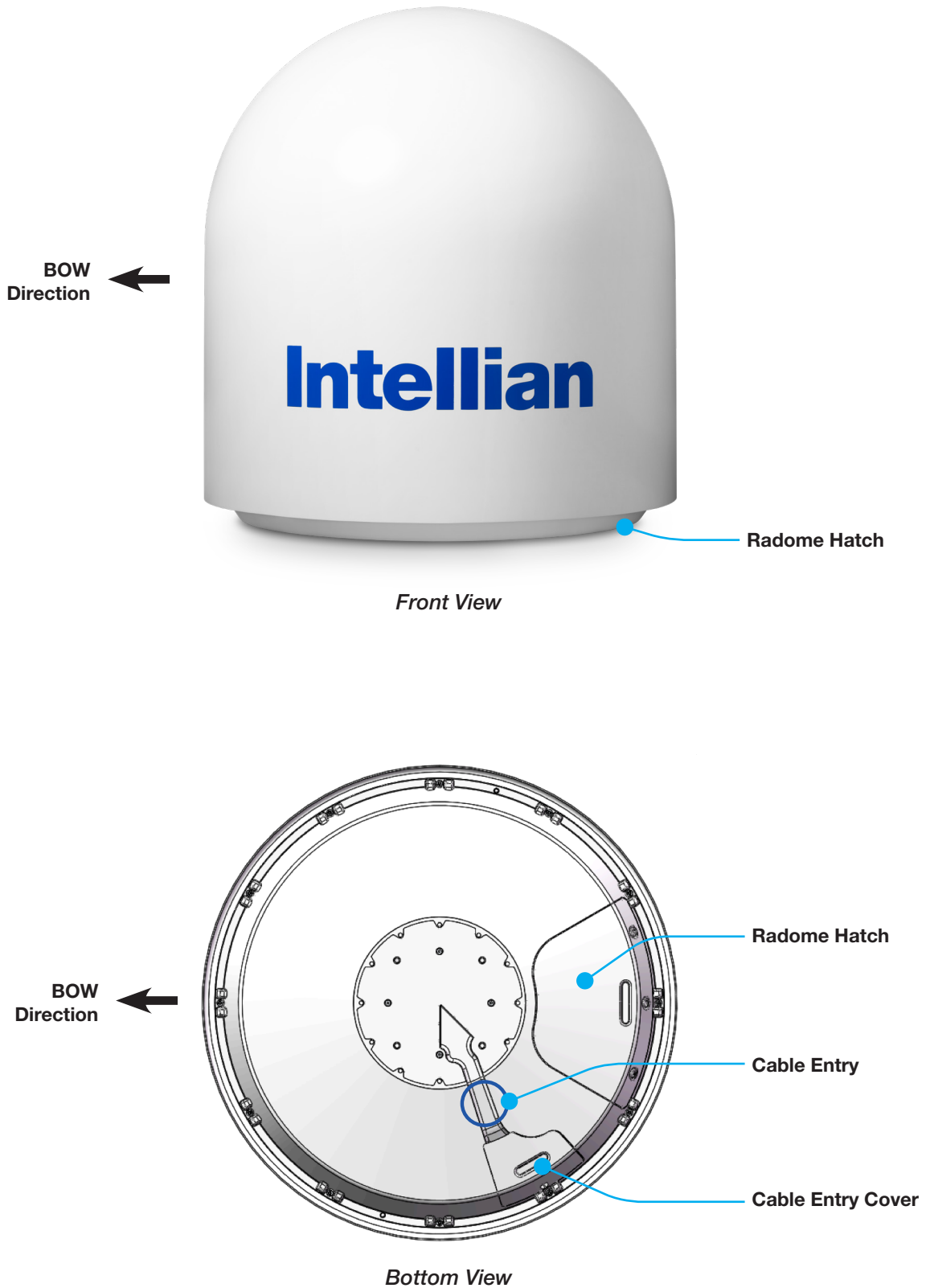

Figure: Antenna Heading Alignment

## Mast Designing (Installation Example)

The ADU mast must be designed to carry the weight of the ADU unit. The mast must also be able to withstand on-board vibrations and wind speeds on the radome.

### Option 1. When Placing Cable Inside Mast

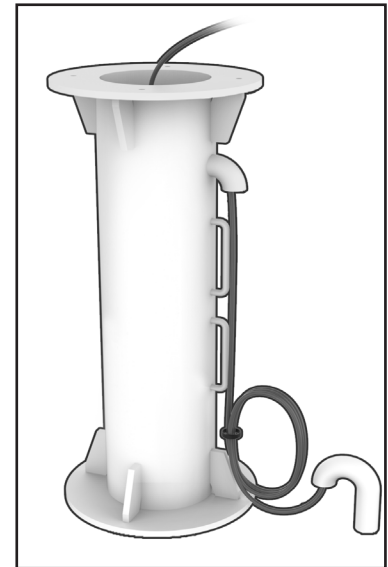
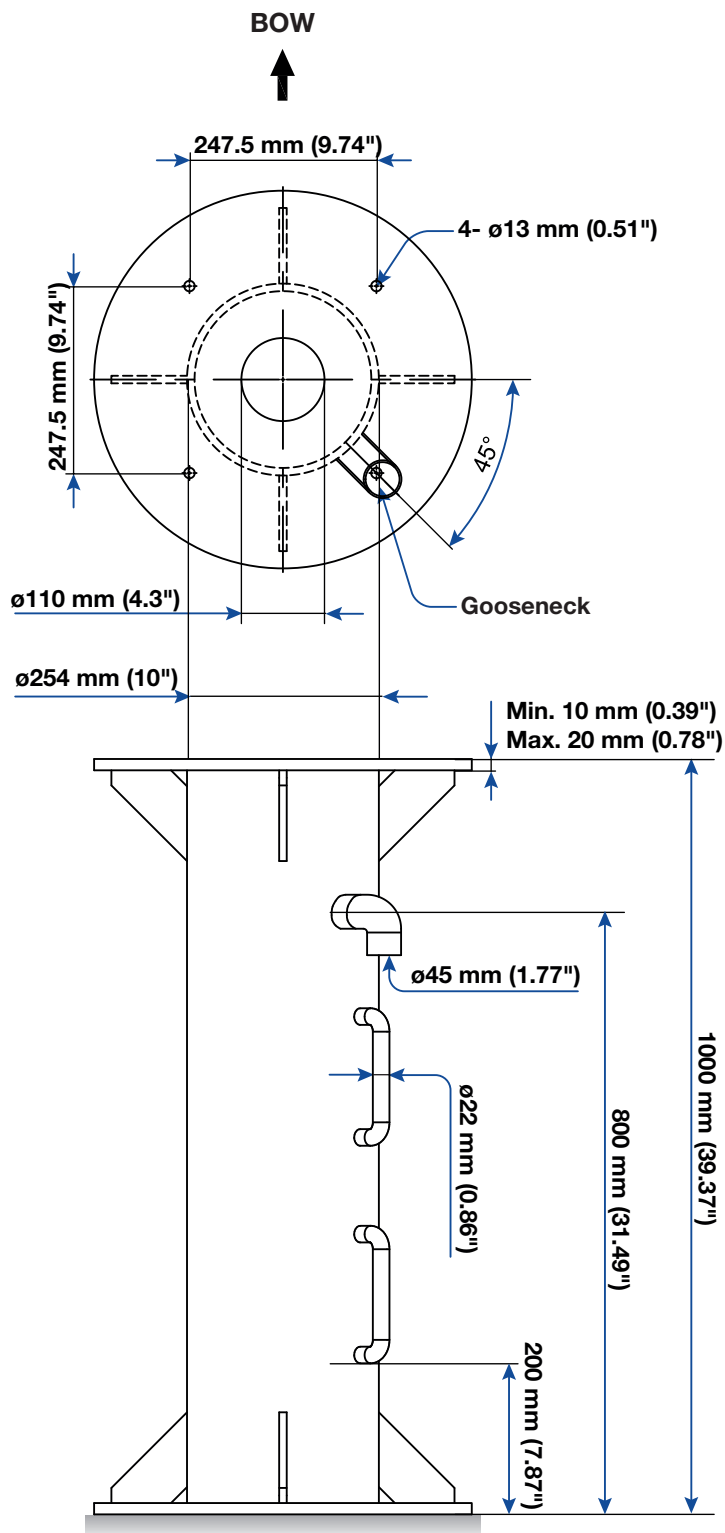

Figure: Recommended Size of Mast (Option 1)

Option 2. When Placing Cable Outside Mast

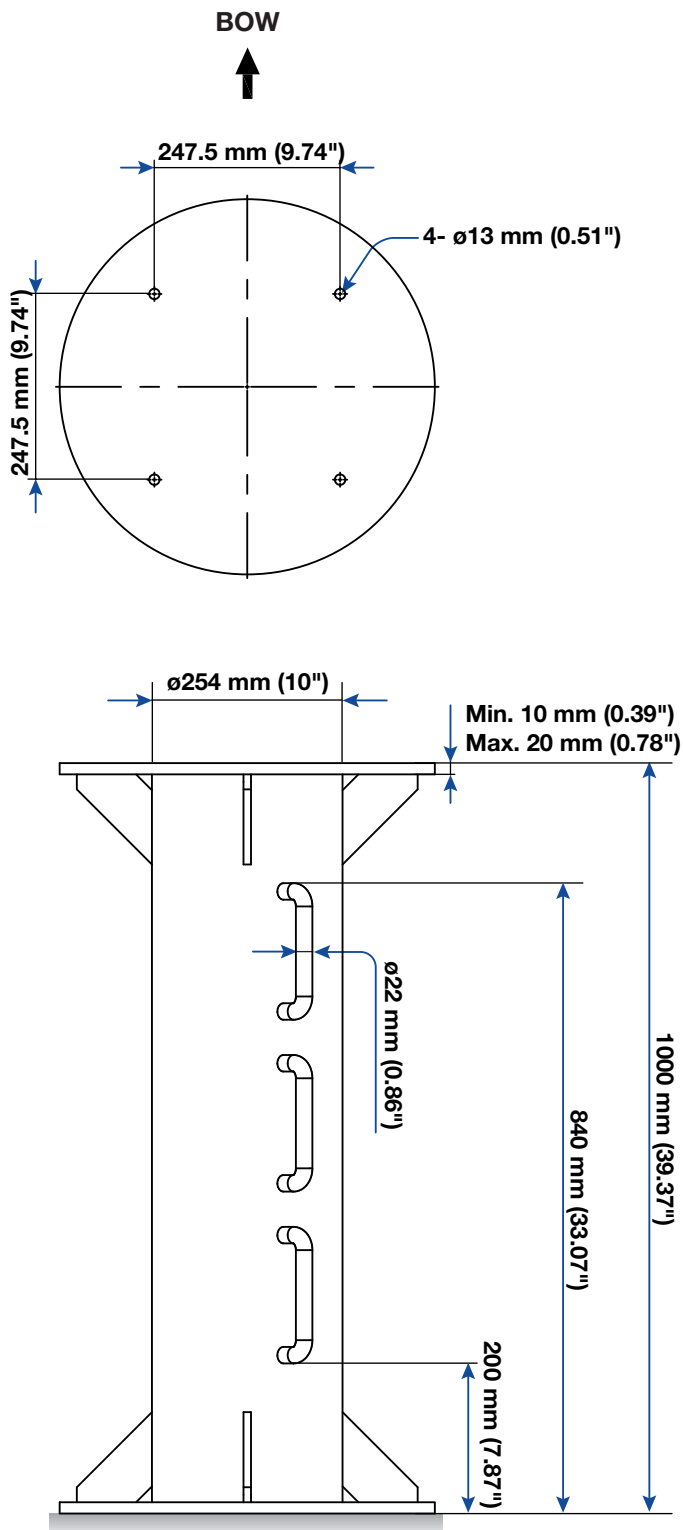

Figure: Recommended Size of Mast (Option 2)

## Antenna Mounting Hole Pattern

The mounting holes must be in the exact same place as shown in the diagram below.

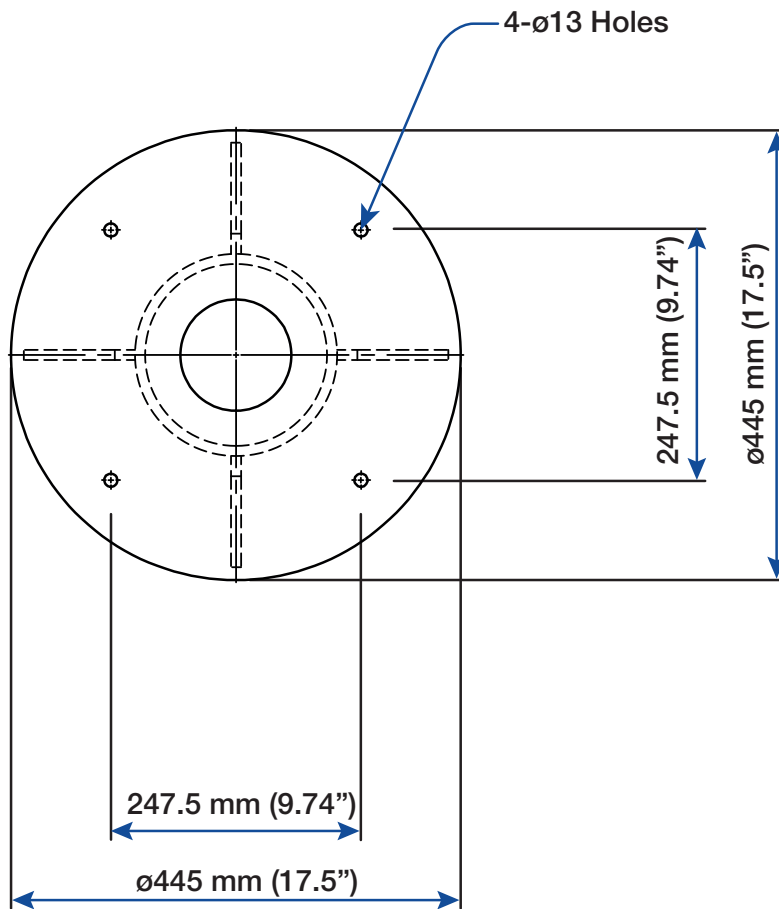

Figure: Antenna Mounting Hole Pattern

## Preparing Installation

The antenna installation requires extreme precaution and safety measures given its size and weight. Failure to follow the correct installation process may lead to injury of the installer and/or cause damage to the system. In order to maximize the performance of the system, a thorough review of this installation guide is strongly recommended, as well as executing the installation process as it is noted in this manual.

### Selection of Installation Site

The system should be placed in an area onboard the vessel with little to no RF signal blockage. When the antenna is transmitting, obstacles in way of the beam path will cause decreased satellite signal strength. The antenna unit should have direct line-of-sight with the desired satellite without any obstacles in the beam path. Certain minimum distances between the antenna and other onboard devices must also be considered during installation.

### Minimize Satellite Blockage

Install the antenna in accordance with the following procedures to ensure maximum performance of the antenna. The ideal antenna site should have a clear view of the horizon or satellite with all around clearance. Please be sure there are no obstacles within the EL range  $-20^{\circ}$  to  $+115^{\circ}$  from the center of the antenna. Obstacles can prevent the antenna from transmitting and receiving the satellite signal.

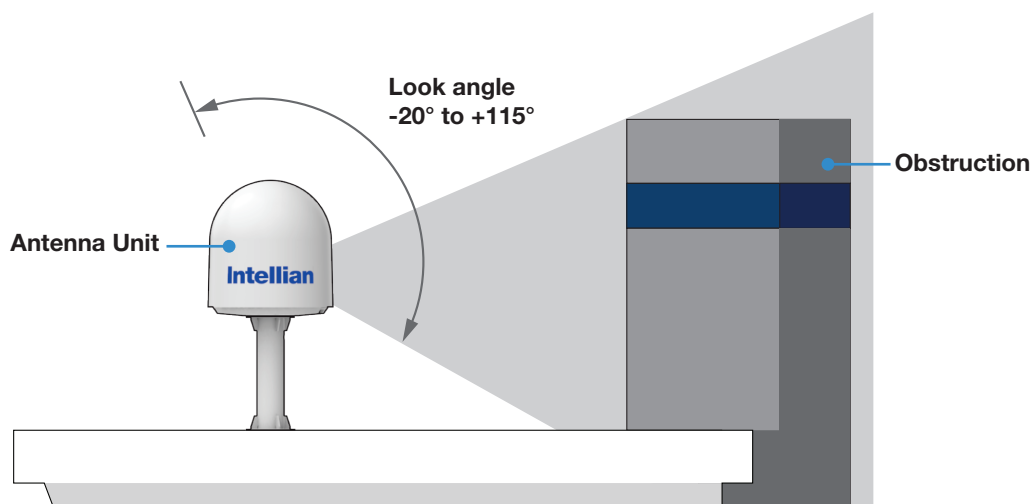

Figure: Elevation Limit of Obstacles

### Avoid RF Interference

Do not install the antenna near the high power shortwave radar. Most radar transmitters emit RF energy within an elevation range of  $-15^{\circ}$  to  $+15^{\circ}$ . For this reason, it is recommended to position the antenna at least 15 feet (4.6 m) away from the radar.

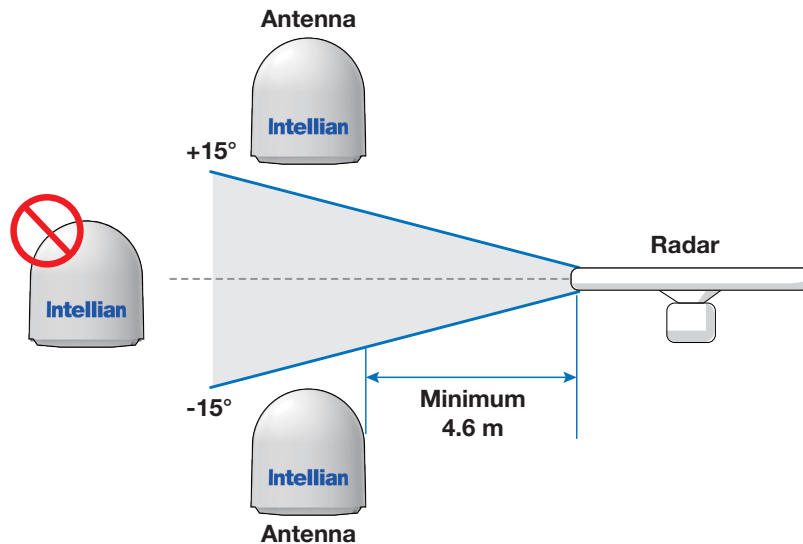

Figure: Potential RF Interference



**WARNING**

Never place the antenna in the beam path of the radar regardless of distance. The high power shortwave radar may impair its performance or damage the antenna.

### RF Hazard Precautions

The antenna is designed to be used with radiation transmitting equipment manufactured by others. Exposure to RF radiation, including exposure associated with an improper use of the transmit equipment, may be hazardous to persons close to the above deck unit. Ensure the safety of personnel who work on the system. During transmission, ensure to keep the minimum safety distance. The recommended minimum safety distance to the reflector on the focal line is about 15 m, based on a radiation level of  $5 \text{ mW/cm}^2$  that applies under occupational/controlled environment. No hazard exists  $>20^{\circ}$  below the antenna's mounting plane.

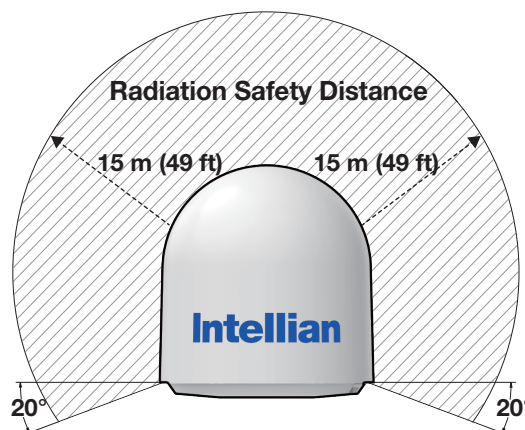

Figure: RF Hazard Precautions

## Preparing System Cables

Before installing the system cables, you need to take the following points into consideration.

1. All cables need to be well clamped and protected from physical damage and exposure to heat and humidity.
2. A cable with an acute bend should be avoided.
3. Wherever a cable passes through an exposed bulkhead or deck head, a watertight gland or swan neck tube should be used.

For cables that run longer than Intellian's recommendations, please consult Intellian Technologies.

- **RF Cable (Customer Supplied)**

Due to the signal losses across the length of the RF coax on L-Band, Intellian recommends the following 50 ohm coax cable types for standard system installations. For cables that run longer than 120 meters (except LMR600 coaxial cable type), please consult Intellian Technologies.

\* The maximum DC Resistance of RF Cable is 0.8 Ohm.

| Coaxial Cable Type | Attenuation in dB/100m (@ 2 GHz) | Attenuation in dB/m (@ 2 GHz) | Recommended Max. Cable Length |
|--------------------|----------------------------------|-------------------------------|-------------------------------|
| LMR400             | 19.6                             | 0.196                         | 80 m                          |
| LMR600             | 12.8                             | 0.128                         | 120 m                         |

- **Gyrocompass Cable (Customer Furnished)**

Due to the environment of various types of vessels, Intellian recommend the general cable types compatible with the antenna.

|                            | NMEA 2000                            | NMEA 0183  |
|----------------------------|--------------------------------------|--|
| <b>Connector Type</b>      | Mini-C 5 pin connector               | 2 pin terminal block connector                             |
| <b>Cable Type</b>          | 5 wires within a single cable        | 2-wires constructed with one enclosed shield cable         |
| <b>Heading Information</b> | Supports PGN, 127250: Vessel Heading | Supports \$HEHDT , baud rate 4800, format 8N1 as standard. |



## Placing Cable on Mast

The cable must be routed from the antenna and through various areas of the ship to end up at the antenna control unit. When pulling the cables in place, avoid sharp bends, kinking, and excessive force. After placement, seal the deck penetration gland and tie the cable securely in place. The cable bracket must be installed on the mast to fix the relevant cable. The gooseneck must be installed on the side of the mast to protect the relevant cable against water.



### WARNING

Ensure that cable has been run through watertight fittings to prevent water entry into the vessel when installation is completed.

### Option 1. Placing Cable Outside Mast

1. Place the cable from the gooseneck labeled on the deck to the antenna as shown in the picture.
2. Maintain a sufficient cable length (more than 2M) from the surface of the mast. After connecting the cable to cable connector inside the cable entry, adjust the cable length and then fix the cable on the cable bracket by using cable ties.

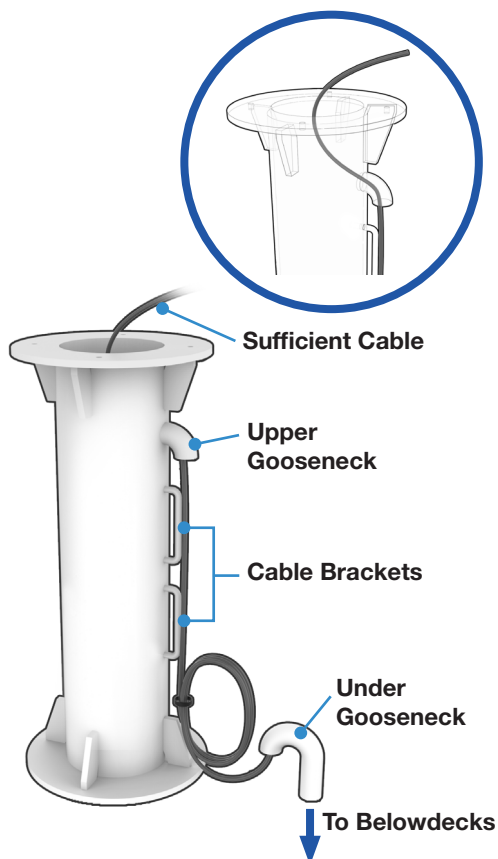

Figure: Cabling on Inside of Mast

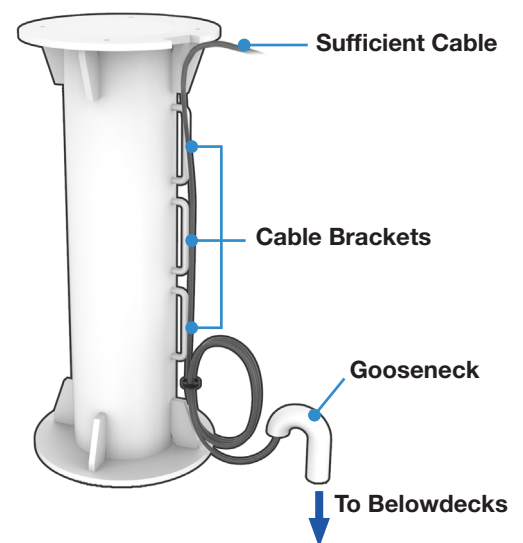

Figure: Cabling on Outside of Mast

### Option 2. Placing Cable Inside Mast

1. Before placing the radome on the mast, the cable should route through the upper gooseneck from the under gooseneck labeled on the deck to facilitate connecting RF Cable to the antenna as shown in the picture.
2. Maintain a sufficient cable length (more than 2M) from the surface of the mast. After connecting the cable to cable connector inside the cable entry, adjust the cable length and then fix the cable on the cable bracket by using cable ties.

# Installing Antenna

## Antenna Installation

### Unpacking Wooden Crate

The pallet should be lifted by means of a forklift. To unpack the wooden crate, follow the procedure below.

1. Locate one of the side panels with a paper sticker (Unpack Guide). Detach this side panel by removing the fixing screw (1EA) and clips (6EA).



CAUTION

#### CAUTION

Be careful with the direction of the panel that you must open first.

**1-1**  : 1EA

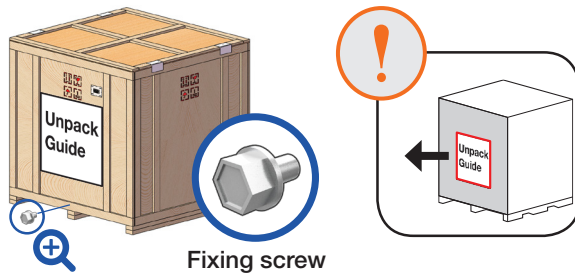

**1-2**  : 6 EA

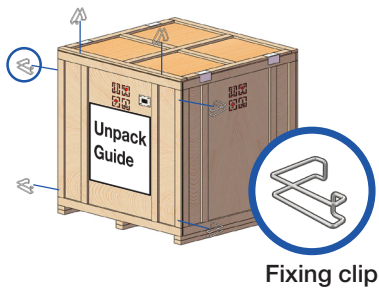

**1-3**

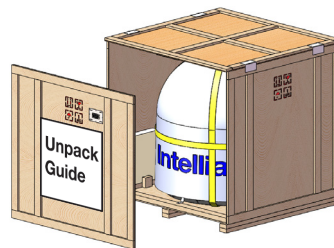

2. The ACU box is located inside the side panel. Take out the ACU box by removing fixing screws (2EA) on the ACU bracket.

**2-1**

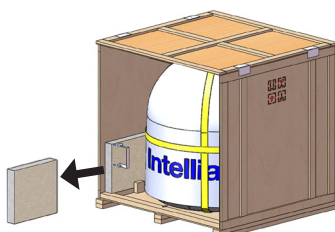

**3. Running Diagnostic Tests:** *This step is optional.* After removing one of the side panels, you can run the diagnostic tests easily to verify the condition of the antenna. First, prepare the "RF Cable (Customer Supplied)" to connect the antenna and the ACU.

3-1. Remove the M4x15L Wrench Bolt by using the wrench set then open the cable entry cover.

3-2. Connect the "RF Cable (Customer Supplied)" from the "ANTENNA" connector on the rear of the ACU to the "RF Connector" inside cable entry of radome (Antenna).

3-3. Execute diagnostic tests (Full Diagnosis Test) via ACU and check the real-time diagnosis result.

**Optional**

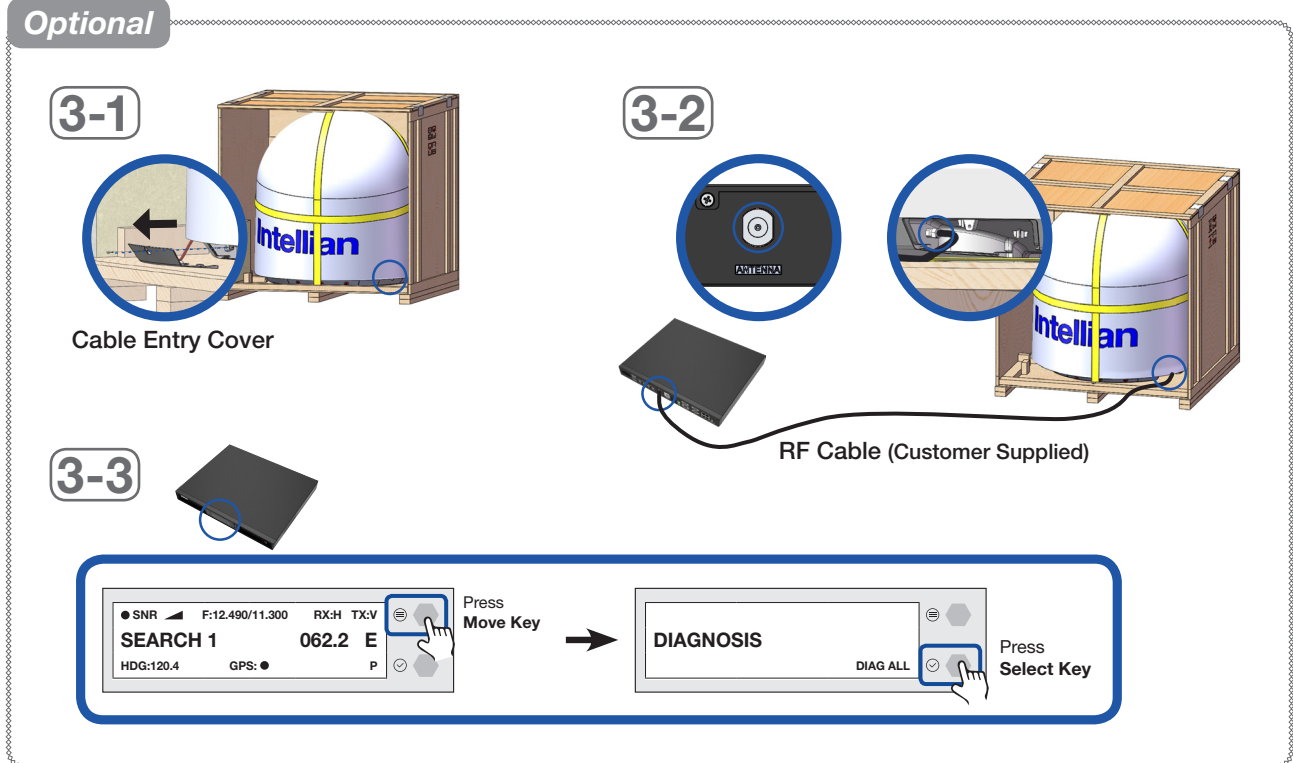

4. Remove the clips (6EA) on the top panel. Detach the top panel by carefully pulling it as shown in the picture.



**WARNING**

The side brackets at the edge of the top panel secure the side panels and top panel in position. When pulling the top panel, ensure that the top panel doesn't fall on the radome.

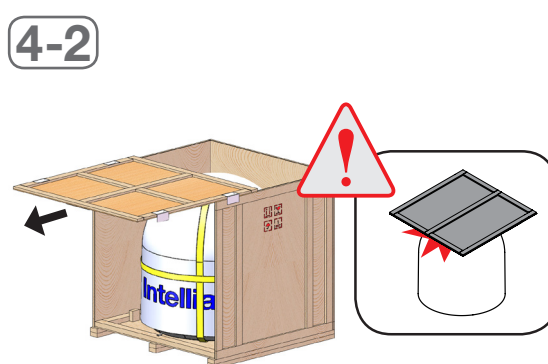
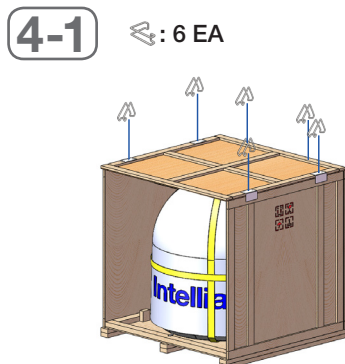

5. Remove the fixing screws (7 EA) from the remaining side panels, then detach the side panels.

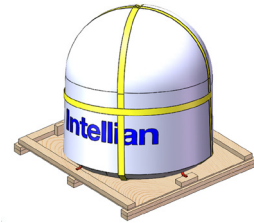
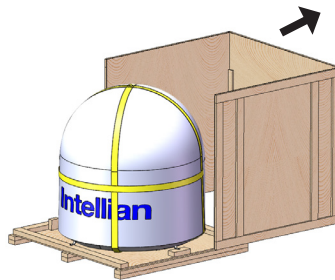
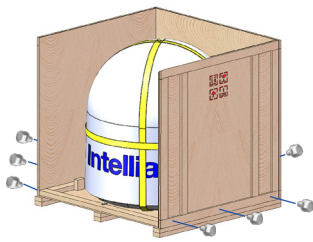

### Removing Antenna from Wooden Crate

Four radome brackets secure the antenna to the pallet. To remove the radome bracket, follow the procedures below.

1. Remove the hex head wrench bolt (2EA) on the radome bracket that secures the antenna to the pallet using a wrench.

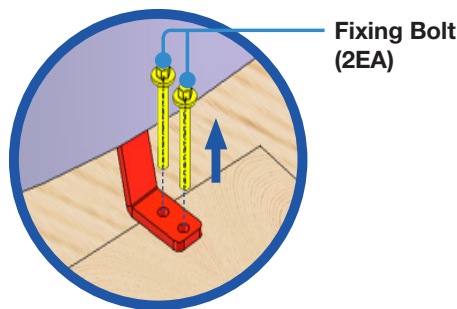
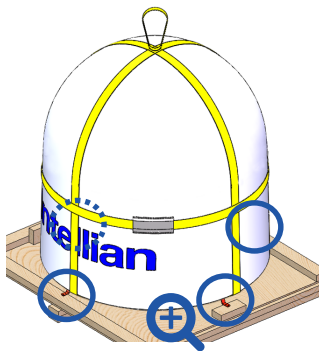

2. Check the condition of lifting strap to make sure the shackles (2EA) are tightened. Re-wrap the shackles with the existing protection to avoid radome damage.

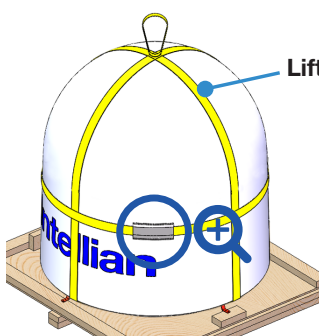

Lifting Strap

Shackles (2EA)

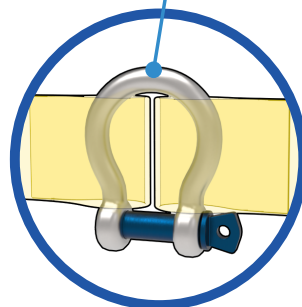

3. Lift the antenna above the bottom pallet using the crane, and maintain sufficient space (max. 100 mm) to remove the shipping brackets.



WARNING

- When lifting the antenna using the lifting straps, make sure to remove the securing radome brackets to separate antenna from the pallet.
- Be careful when lifting the heavy object. Incorrect handling of the heavy object may lead to injury to the installers and/or cause significant damage to the unit.

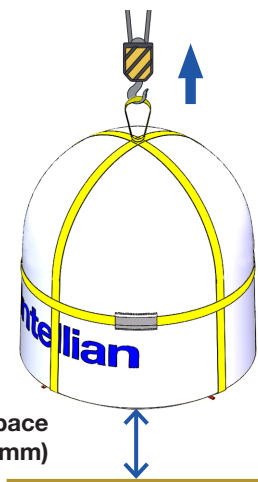

Sufficient Space  
(max. 100 mm)

4. Remove the radome bracket bolt (1EA) using a wrench, then detach the radome bracket from the radome.
5. After removing radome bracket, apply Loctite #263 to the bolt's threads to ensure the bolts are fastened firmly. Fully tighten the detached radome bolt (1EA) using a wrench. Apply the same procedure to all four parts.

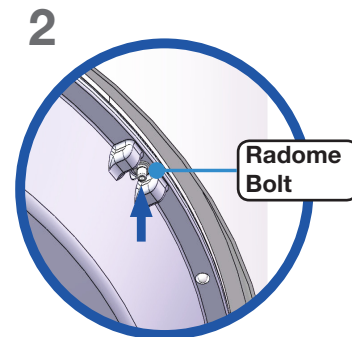
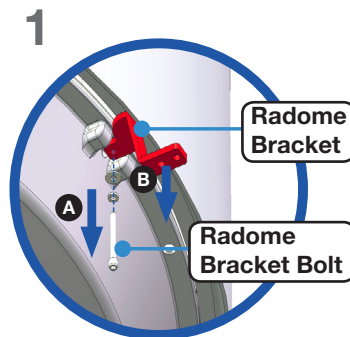
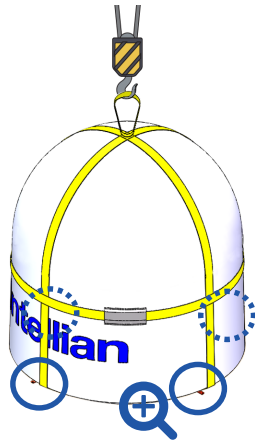

Fully Tighten Radome Bolt

### Placing Antenna on Mast

The Intellian antenna comes with the lifting straps pre-mounted from the factory. Check the condition of the lifting strap ensure the shackle is tightened up. Lift the antenna above the mast using a crane and carefully put the antenna down on the mast. When placing the radome, consider that the antenna should be positioned with the BOW marker aligned as close as possible to the ship's heading.



#### WARNING

The antenna may be subject to swaying motions in windy conditions. Be careful when handling the antenna.



## Attaching Waterproof Foam

The waterproof foam must be attached to prevent water from penetrating inside the Radome before fully mounting the radome to the mast. Make sure the foam is attached in the same position as in the picture below.

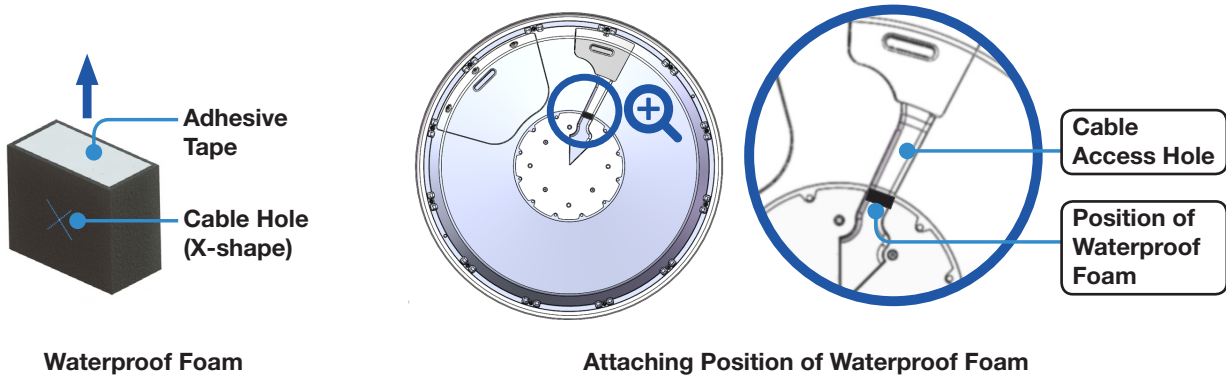

### Case 1. When Placing Cable Outside Mast

1. Peel off the paper from the supplied waterproof foam to expose the adhesive.
2. Attach the waterproof foam firmly onto the surface of the cable access hole.
3. Pull the RF cable from the mast.

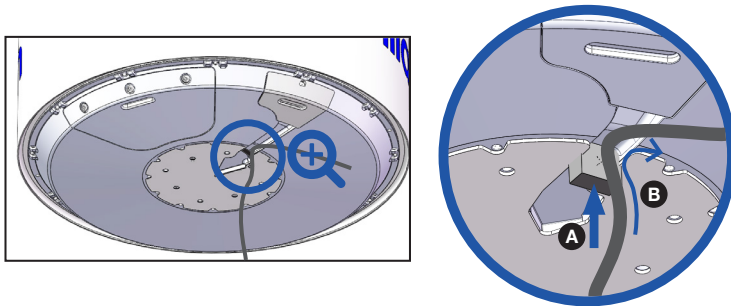

### Case 2. When Placing Cable Inside Mast

1. Peel off the paper from the supplied waterproof foam to expose the adhesive.
2. Pull the RF cable from the mast through the cable hole (X-shape).
3. Then attach the waterproof foam firmly onto the surface of the cable access hole. When moving the radome, be careful not to let the waterproof foam or the cable fall down.

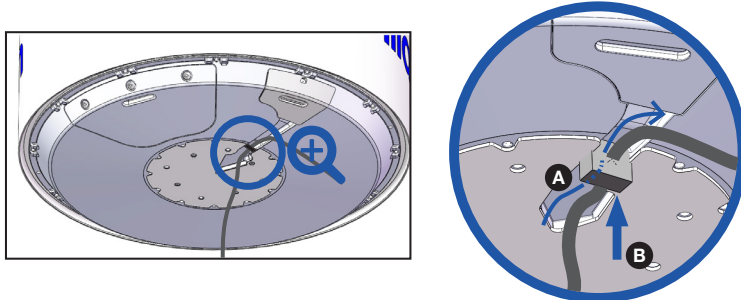

## Mounting Radome

Bring the Bolt Kit (4EA) from the ACU box. Before assembling bolts, apply Loctite #263 to the bolt's threads to ensure the bolts are fastened firmly. Insert the bolts and washers from under the mast into the radome, and fasten them to the nuts assembled inside the radome. After mounting the antenna on the mast, remove the lifting strap.

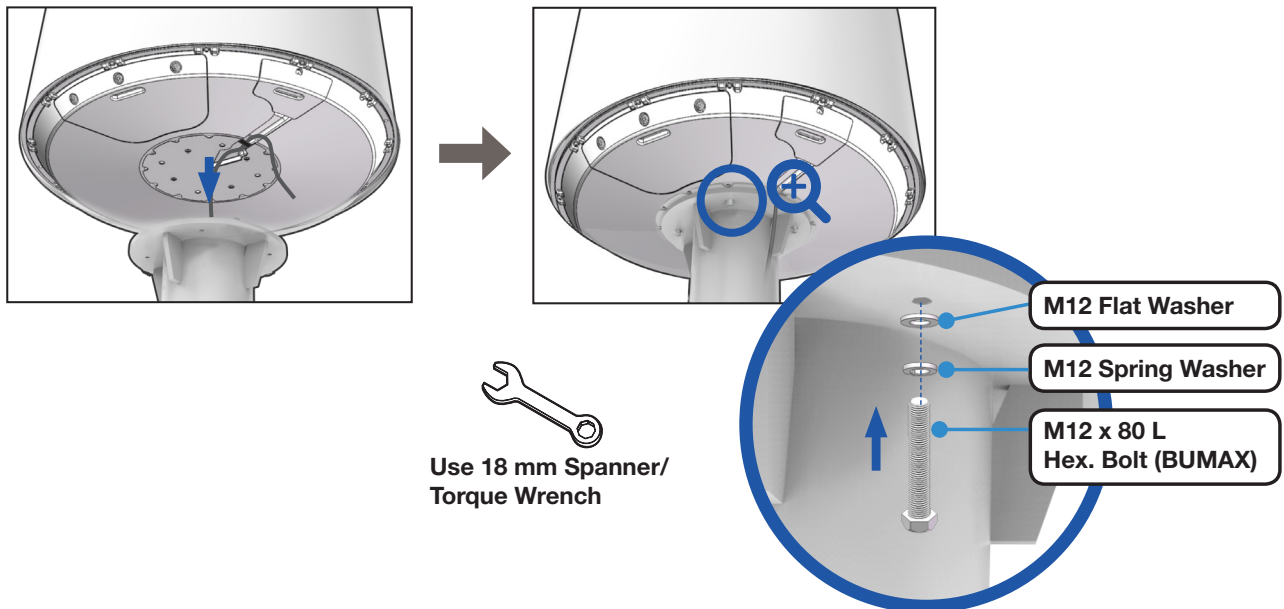

NOTE

### NOTE

- Make sure the cable from the mast is aligned with the cable entry of antenna bottom for a stable connection.
- If the mast's surface thickness is greater than 20 mm, use a M12x100L Hex Bolt.
- To fasten the M12 bolts use a torque setting of 110 Nm.

## Connecting RF Cable (Customer Supplied)

Connect the "RF Cable" from the "ANTENNA" connector on the rear of the ACU to the "RF Connector" inside the cable entry of radome. In the cable connection on both sides, cable termination should be completed using suitable tools. After connecting, securely fix the cable by using the cable ties in place.

1. Remove the M4x15L Wrench Bolt by using the wrench set then open the cable entry cover.

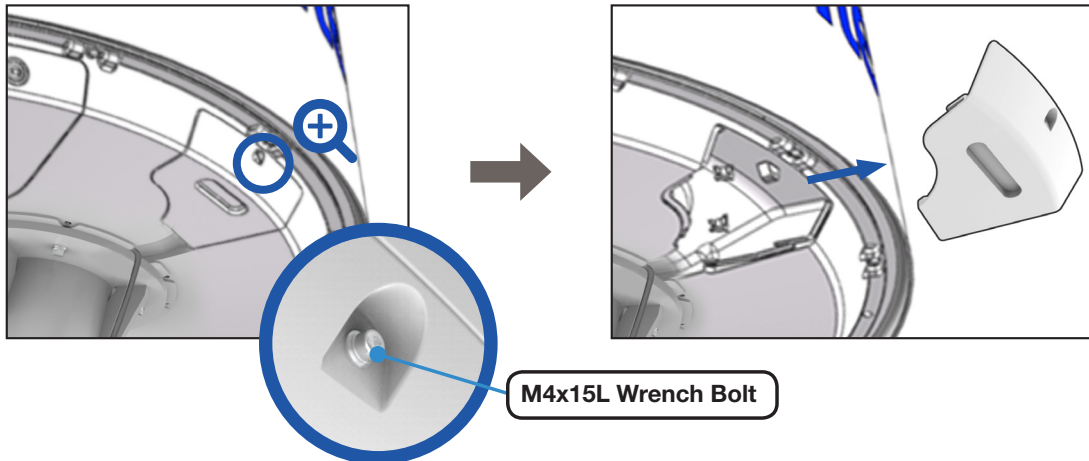

NOTE

### NOTE

After removing the M4x15L Wrench Bolt from the cover of cable entry, Keep it in a safe place for the next step. When closing the cover of cable entry, this bolt must be used.

2. Terminate N(M) connector on the end of the RF Cable. Intellian recommends using a genuine cable connector and tools. Refer to the cable termination instructions provided by the manufacturer to terminate the N connector.
3. Connect the terminated RF cable to the connector as shown in the figure below. Ensure the cable is firmly fastened to the connector. Fasten the cable with cable ties using the cable mount or cable clamp along the routing path.

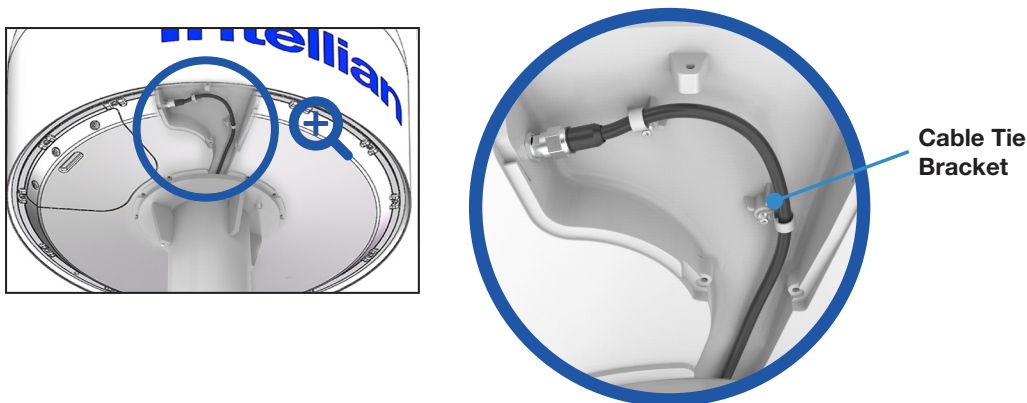

4. After completing cable connection, put the cover in the right place and tighten the M4x15L Wrench Bolt by using the wrench set.

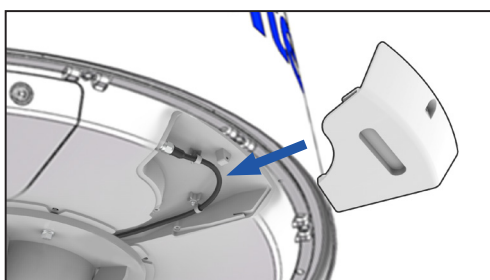



## Switching On Power Box

Access the ADU modules inside the radome to check that the power switch is on through the radome hatch. Make sure that there is sufficient free space underneath the ADU to open the radome hatch.

1. Bring the radome door key from the ACU box. Open the radome hatch by turning the fixed bolts counterclockwise by using the radome door key.

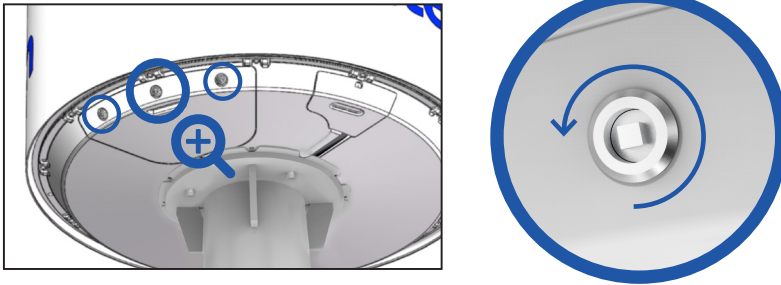

2. The power box switch was turned on and shipped from the factory. Check the power box inside the radome is switch on. If not, switch on the power box.

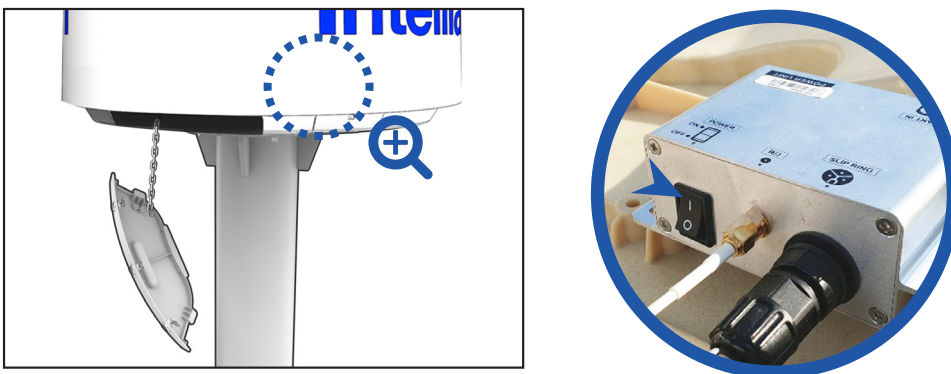

3. Put the radome hatch in the right place. Close the radome hatch by turning the fixed bolts clockwise by using the radome door key.

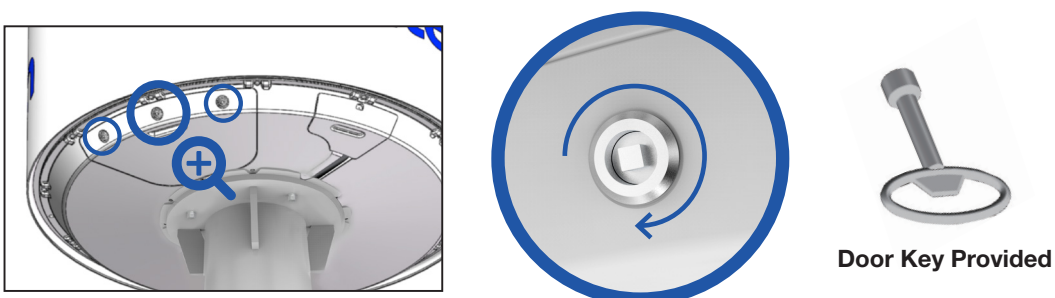

### NOTE

After using the door key, store it in a safe place for future use.

NOTE

# Installing ACU

## Selection of ACU Installation Site

The ACU should be installed below deck, in a location that is:

- Dry, cool and ventilated.
- The front panel should be easily accessible to users.

## ACU Dimensions

Confirm the dimension of the ACU before installing it.

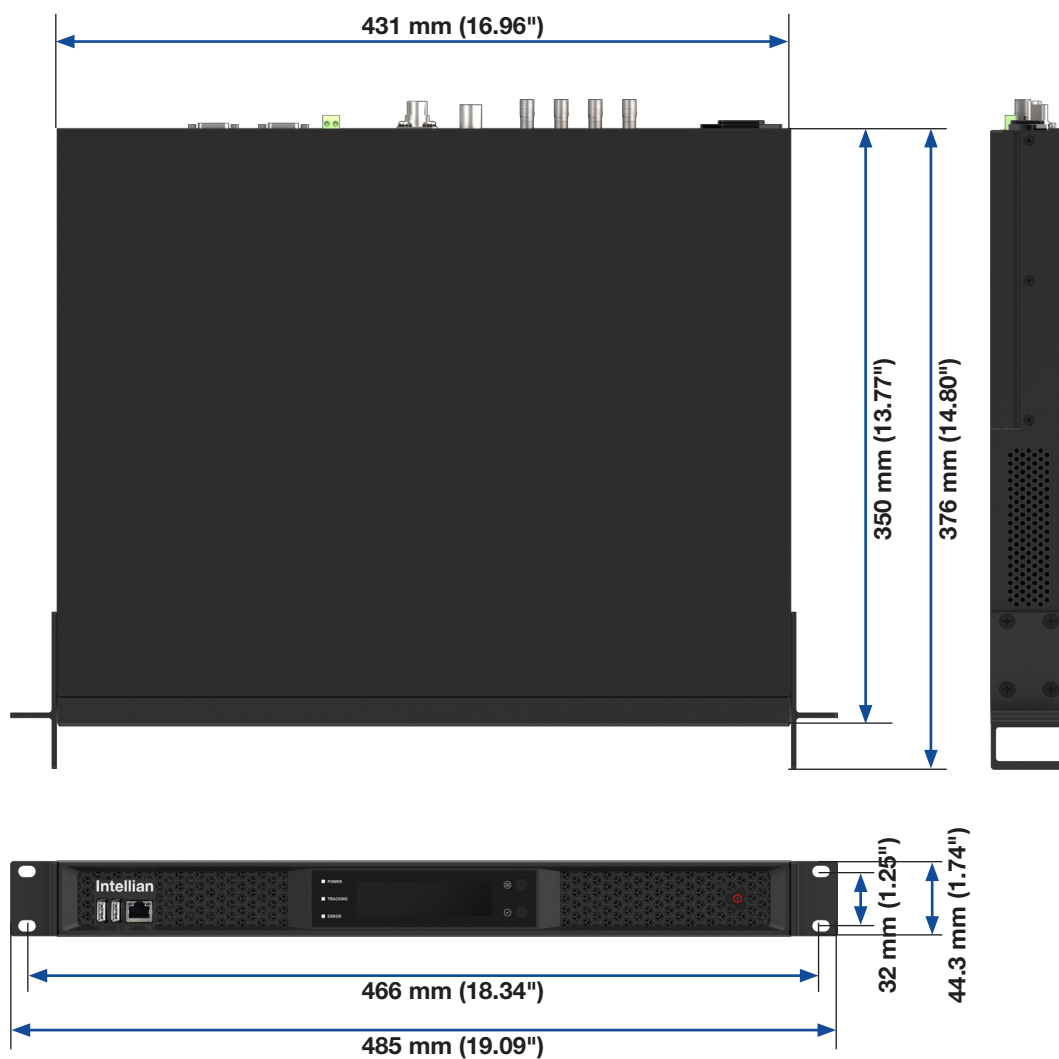

Figure: ACU Dimensions

## Mounting ACU

Intellian supplies 19" Rack Mounting Brackets to mount the ACU in a rack.

### 19" Rack Mount Type

The ACU should be installed using the two supplied 19" Rack Mounting Brackets. Using the Flat Head Screw supplied, attach the mounting brackets to the sides of the ACU. Place the ACU in the location where it is going to be installed. Connect the cables to the rear of the ACU.



*Figure: 19" Rack Mount Type ACU*



#### **WARNING**

Ensure that the cables connected to the ACU are long enough to prevent damage when the ACU is pulled out from the rack.

## System Configurations

For your satellite communication system to work properly, the system will have to be connected with all of the provided components as shown in the figure below. Separate purchase of a satellite modem, switch router and ship's gyrocompass may be required.

### Single Antenna System Configuration (Basic Antenna System)

The Basic system consists of one VSAT antenna and one ACU. As shown in the configuration below, connect the cables correctly.

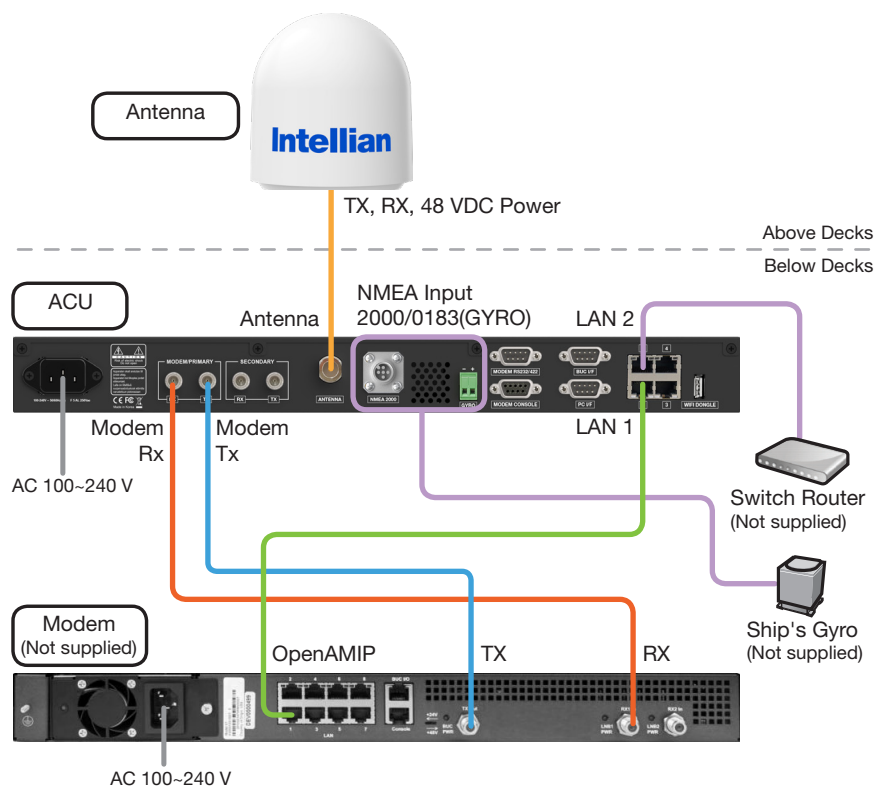

Figure: Single Antenna System Configuration (Basic Antenna System)

### Dual Antenna System Configuration (Optional)

The dual system consists of two VSAT antennas and two ACUs. The ACUs have embedded Dual Antenna Mediator function, which is capable of controlling and managing two VSAT antenna systems simultaneously. As shown in the configuration below, connect the cables correctly.

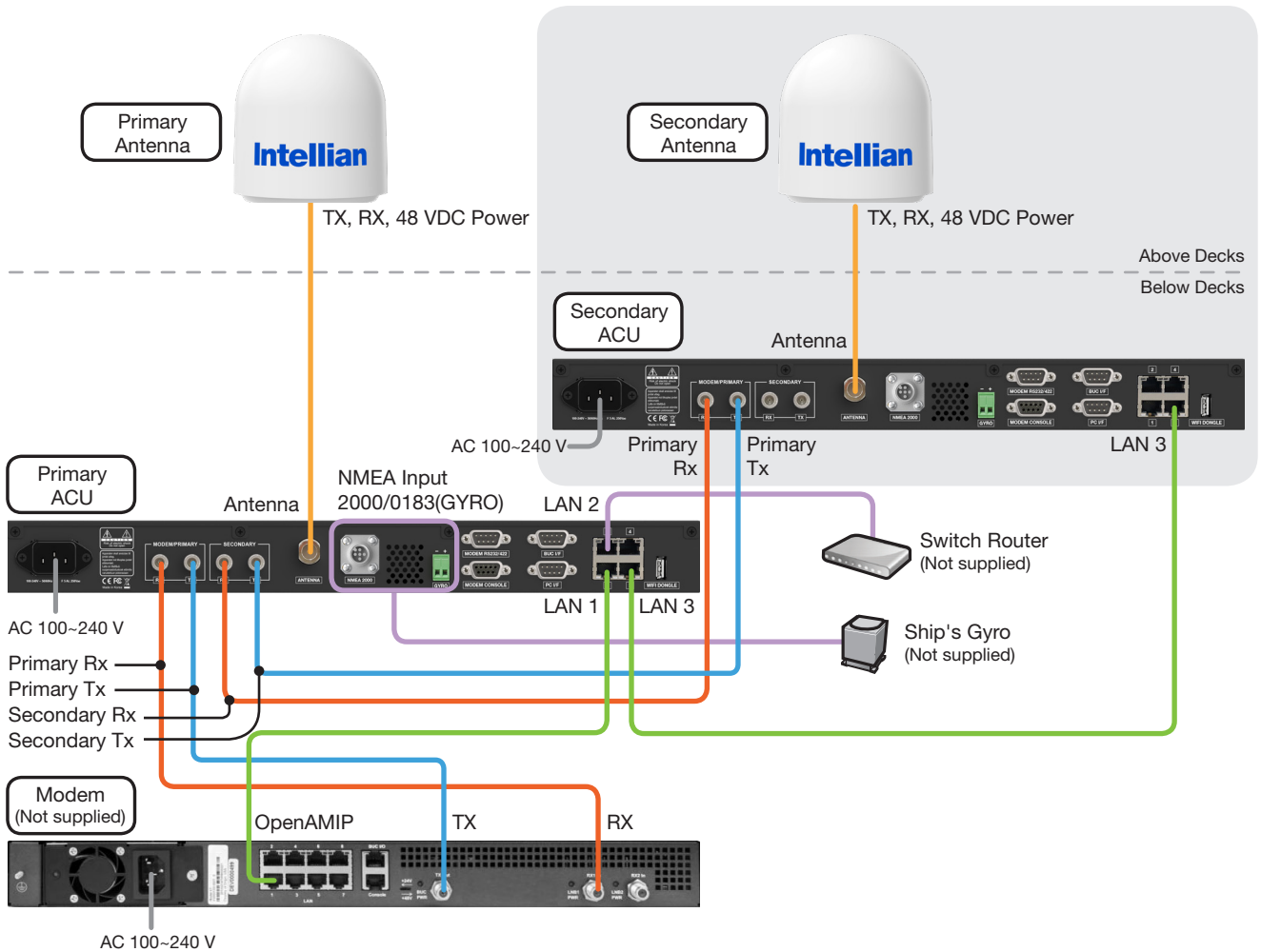

Figure: Dual Antenna System Configuration



**NOTE**

The description of this Dual Antenna System is written on the "Appendix A" chapter. Refer to the "Using Dual Antenna System" on page 121 for more details.

# ACU Cable Connection

## Name of ACU Rear Panel

The following figure shows the ACU's rear panel.

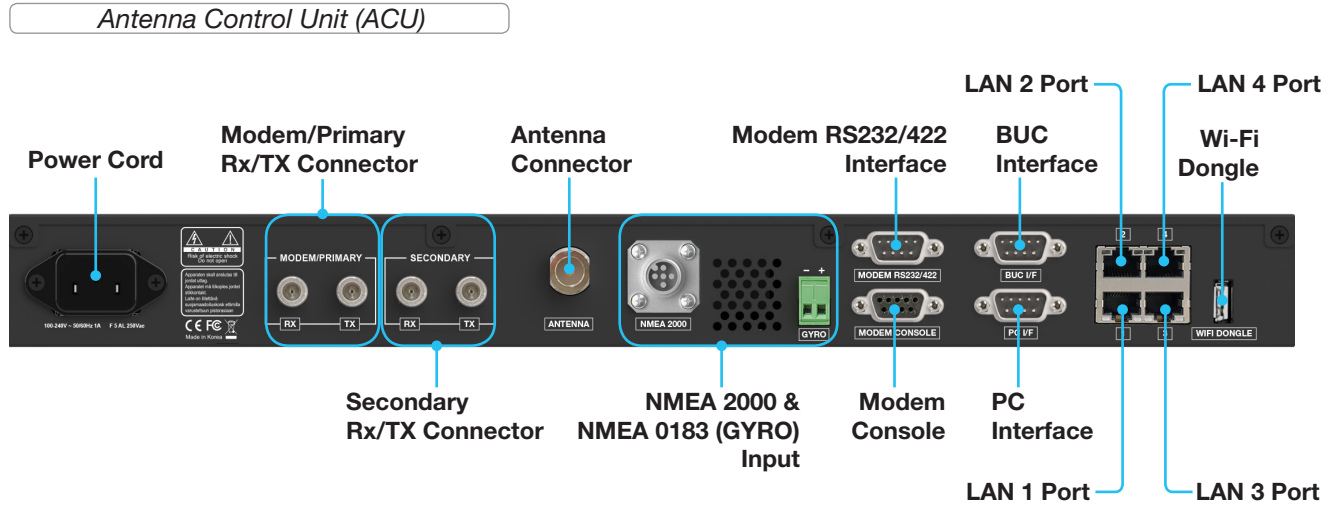

Figure: Name of ACU Rear Panel

## Connecting to the Antenna

Connect the "RF Cable (not supplied by Intellian)" from the "ANTENNA" connector on the rear of the ACU to the "RF Connector" inside cable entry of radome (Antenna).

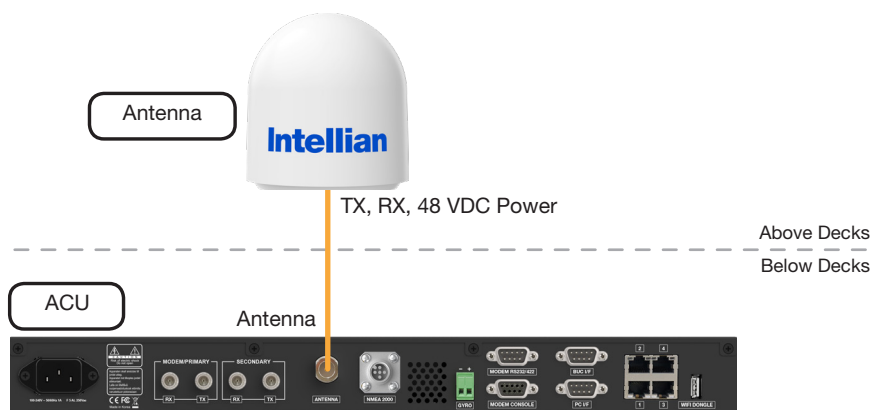

Figure: ACU to Antenna Cable Connection

### Connecting to Antenna (Optional: For Dual Antenna System)

To use the Dual Antenna System, the antenna system needs to be installed with two ACUs and two antennas to support the Dual Antenna System operation.

Connect the "RF Cable (not supplied by Intellian)" from the "ANTENNA" connector on the rear of the "Primary ACU" to the "RF Connector" inside cable entry of radome (Primary Antenna).

Connect the "RF Cable (not supplied by Intellian)" from the "ANTENNA" connector on the rear of the "Secondary ACU" to the "RF Connector" inside cable entry of radome (Secondary Antenna).

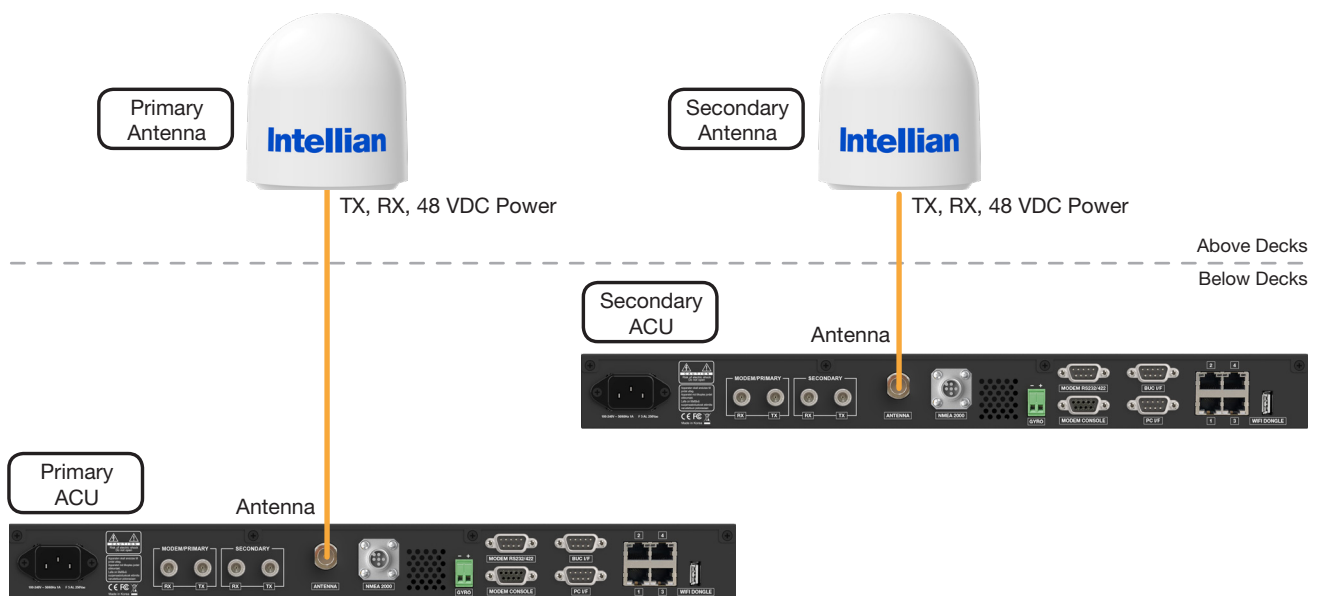

Figure: ACU to Antenna Cable Connection for Dual Antenna System

### Connecting to Modem

Connect the "RG-6 RF cable" from the "MODEM Rx" connector on the rear of the ACU to the "Rx connector" on the modem.

Connect the "RG-6 RF cable" from the "MODEM Tx" connector on the rear of the ACU to the "Tx connector" on the modem.

When using the OpenAMIP, connect the "Ethernet cable" from the "LAN 1" port on the rear of the ACU to the "LAN" port on the modem.

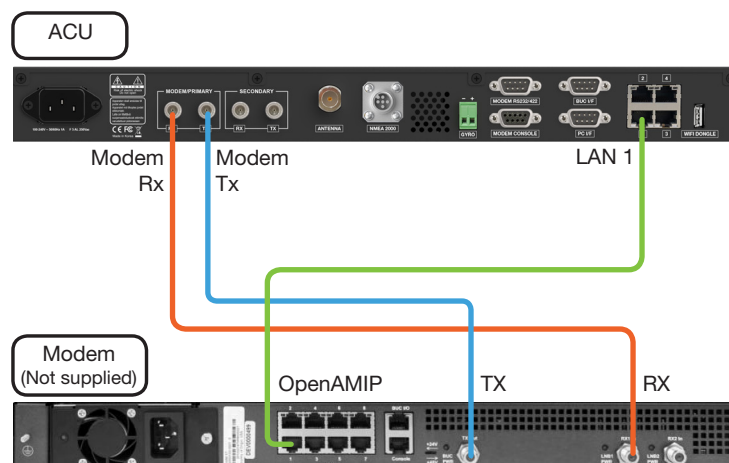

Figure: ACU to Modem Cable Connection

## Connecting to Additional ACU (Optional: For Dual Antenna System)

To use the Dual Antenna System, the antenna system needs to be installed with two ACUs and two antennas to support the Dual Antenna System operation. The Primary ACU is connected to the additional Secondary ACU as follows.

Connect the "RG-6 RF cable" from the "SECONDARY-Rx" connector on the rear of the "Primary ACU" to the "PRIMARY-Rx" connector on the rear of the "Secondary ACU".

Connect the "RG-6 RF cable" from the "SECONDARY-Tx" connector on the rear of the "Primary ACU" to the "PRIMARY-Tx" connector on the rear of the "Secondary ACU".

Connect the "Ethernet cable" to the each "LAN 3" connector on the rear of the "Primary ACU" and "Secondary ACU".

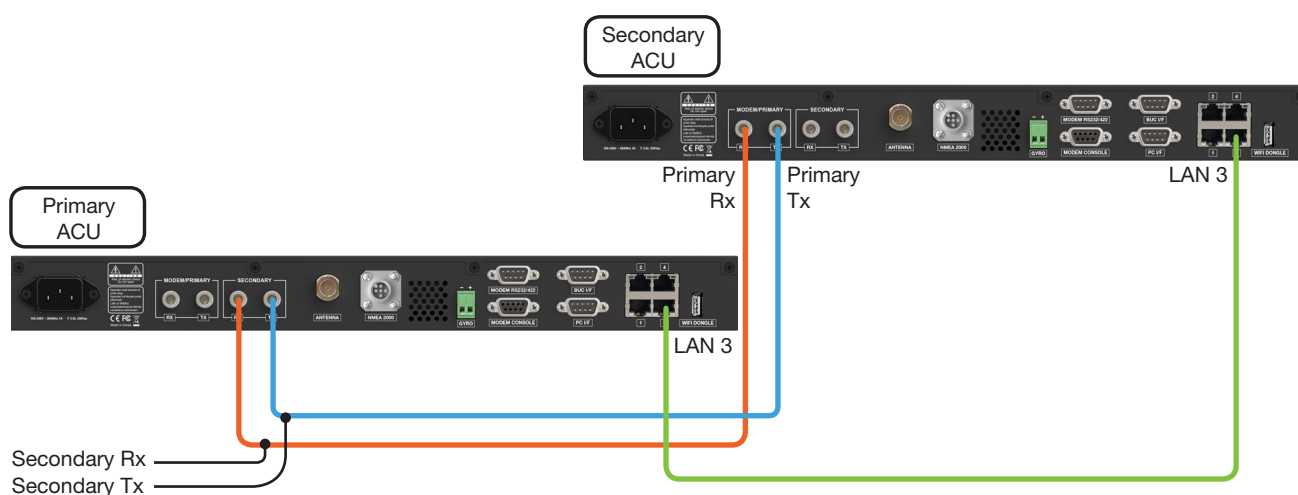

Figure: Additional ACU Cable Connection for Dual Antenna System

## Connecting to Switch Router

Connect the "Ethernet cable" from the "LAN 2" port on the rear of the ACU to the "LAN" port on the Switch Router.



Figure: ACU to Switch Router Cable Connection



## Connecting Ship's Gyrocompass

For satellite tracking, you must connect a ship's gyrocompass to the antenna system through the gyrocompass interface on the rear of the ACU. Intellian's ACU supports NMEA 0183 (GYRO) and NMEA 2000 gyrocompass inputs. If the ship's gyrocompass output uses a different standard, a compass converter should be installed to supply the required NMEA input. The NMEA 2000 gyrocompass needs to be purchased separately, please refer to the "ACU Connector Pinouts Guide" on page 42 for pin configuration.

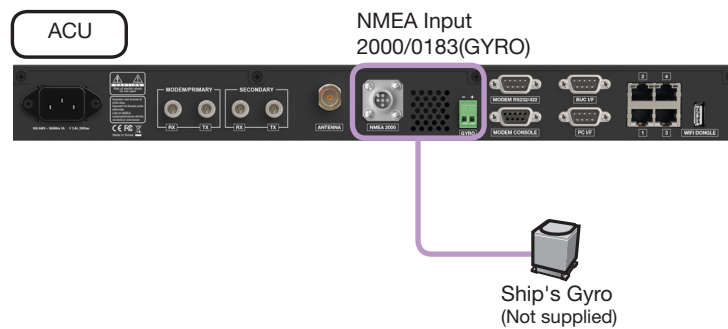

Figure: ACU to Ship's Gyrocompass Cable Connection

## How to Connect NMEA 0183 Gyrocompass Cable

1. Turn the screw located on the top of the 2-position terminal block counterclockwise enough using the Phillips Screwdriver.
2. Connect NMEA 0183 Gyrocompass Cable to the terminal block.



NOTE

### NOTE

When connecting the NMEA 0183 gyrocompass cable:

1. The positive and negative marks are shown on the top of the terminal block. Check the positive and negative and correctly connect the cables.
2. Strip the end of the cables up to 5 mm (0.2"). Do not solder the cables.

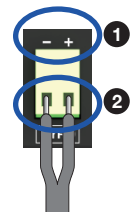

3. Fully turn the screw clockwise to secure the cable. Apply equally to both positive and negative cables.

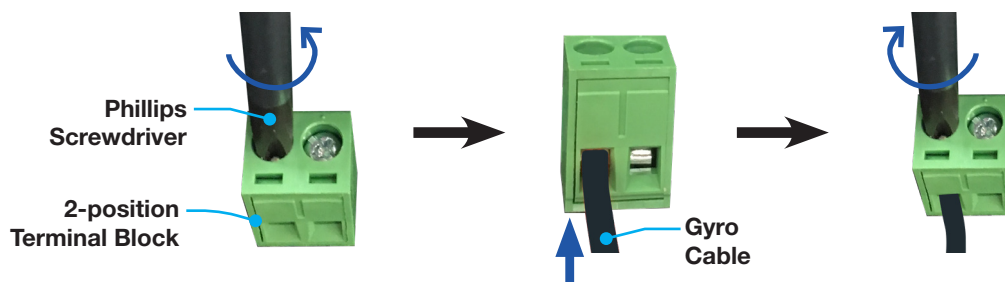

Figure: NMEA 0183 Gyrocompass Cable Connection

## ACU Connector Pinouts Guide

The ACU connector pins and their corresponding descriptions are shown in the figure and table.

### Console Connector (Modem Interface)

Antenna Control Unit (ACU):

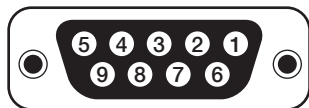

*D-Sub 9 Pin: MODEM CONSOLE  
(Female Connector Type)*

Cable Connector:

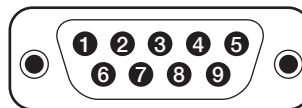

*D-Sub 9 Pin  
(Male Connector Type)*

| Pin | Signal     |
|-----|------------|
| 1   | GND        |
| 2   | GPS_OUTA   |
| 3   | MODEM_LOCK |
| 4   | MUTE 0     |
| 5   | NC         |
| 6   | GPS_OUTB   |
| 7   | EXM_AGC    |
| 8   | MUTE 1     |
| 9   | NC         |

### RS232/RS422 Connector (Modem Interface)

Antenna Control Unit (ACU):

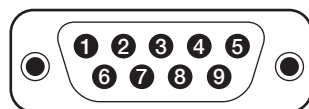

*D-Sub 9 Pin: MODEM RS232/422  
(Male Connector Type)*

Cable Connector:

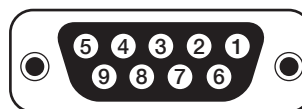

*D-Sub 9 Pin  
(Female Connector Type)*

| Pin | Signal                |
|-----|-----------------------|
| 1   | NC                    |
| 2   | Modem TX / MAX422 RX+ |
| 3   | Modem RX / MAX422 TX+ |
| 4   | NC                    |
| 5   | GND                   |
| 6   | NC                    |
| 7   | MAX422 RX-            |
| 8   | MAX422 TX-            |
| 9   | NC                    |

### RS232 Connector (PC Interface)

Antenna Control Unit (ACU):

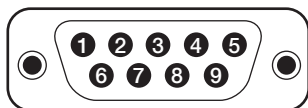

*D-Sub 9 Pin: PC I/F  
(Male Connector Type)*

Cable Connector:

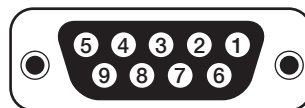

*D-Sub 9 Pin  
(Female Connector Type)*

| Pin | Signal              |
|-----|---------------------|
| 1   | NC                  |
| 2   | PC RX               |
| 3   | PC TX               |
| 4   | NC                  |
| 5   | GND                 |
| 6   | NC                  |
| 7   | IARM TO PC_ DBG_ TX |
| 8   | PC TO IARM_ DBG_ RX |
| 9   | NC                  |

### RS232/RS422 Connector (BUC Interface)

Antenna Control Unit (ACU):

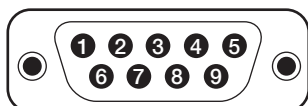

*D-Sub 9 Pin: BUC I/F  
(Male Connector Type)*

Cable Connector:

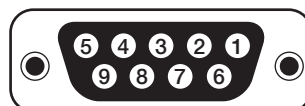

*D-Sub 9 Pin  
(Female Connector Type)*

• For Ku-band Model

| Pin | Signal       |
|-----|--------------|
| 1   | NC           |
| 2   | BUC RS232 RX |
| 3   | BUC RS232 TX |
| 4   | GND          |
| 5   | GND          |
| 6   | NC           |
| 7   | NC           |
| 8   | NC           |
| 9   | NC           |

• For Ka-band Model (Optional)

| Pin | Signal          |
|-----|-----------------|
| 1   | BUC RS422 RX+   |
| 2   | BUC RS422 RX-   |
| 3   | BUC RS422 TX+   |
| 4   | GND             |
| 5   | GND             |
| 6   | BUC RS422 TX-   |
| 7   | BUC KEYLINE RX+ |
| 8   | BUC KEYLINE RX- |
| 9   | NC              |

### NMEA 2000 Connector

Antenna Control Unit (ACU):

Cable Connector:

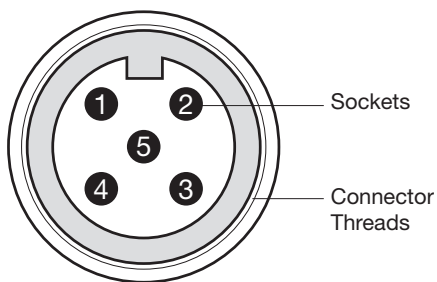

**NMEA 2000 Connector  
(Male Connector Type)**

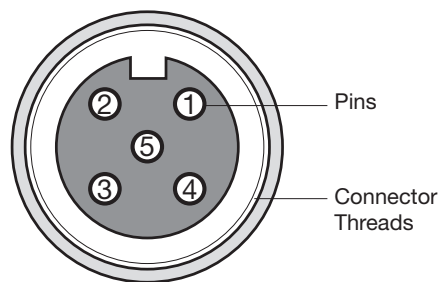

**NMEA 2000 Connector  
(Female Connector Type)**

| Pin | Signal                                |
|-----|---------------------------------------|
| 1   | Shield                                |
| 2   | NET-S,<br>(power supply positive, +V) |
| 3   | NET-C,<br>(power supply common, -V)   |
| 4   | NET-H, (CAN-H)                        |
| 5   | NET-L, (CAN-L)                        |

### LAN 1~4 Ports

Antenna Control Unit (ACU):

Cable Connector:

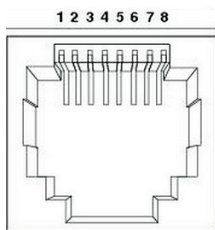

**LAN Ports**

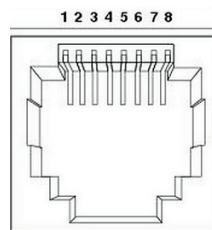

**LAN Ports**

| Pin | Signal |
|-----|--------|
| 1   | Tx-    |
| 2   | Tx+    |
| 3   | Rx-    |
| 4   | NC     |
| 5   | NC     |
| 6   | Rx+    |
| 7   | NC     |
| 8   | NC     |

## ACU to PC Communication Setup

You can establish data communication between the ACU and a PC the using one of the following methods.

### TCP/IP Connection

#### Connection through Front Panel Management Port

The network is automatically configured by DHCP without the need for additional PC IP configuration.

1. Connect an Ethernet cable from the Management LAN port on the front of the ACU to the LAN port of PC.
2. The network connection is established automatically.
3. Use the following IP address to access Intellian AptusNX page.
  - **IP Address: 192.168.2.1 (Default)**



Figure: Front Panel Management LAN Port Connection

### USB Connection:

#### Connection through Front Panel Right USB Port

The "Right USB port" just allows the USB device to be connected to each other for log download, backup/restore antenna settings, and firmware upgrade. The "Left USB port" is only for a service engineer.



CAUTION

#### CAUTION

Make sure that the USB is connected to the "Right USB port" to communicate with the antenna. Do not connect to the "Left USB port".



Figure: Front Panel Right USB Port Connection

## Wi-Fi Connection

### Connection through Rear Panel Wi-Fi Dongle

Intellian provides the Wi-Fi Dongle for Wi-Fi connection. You can connect to the ACU via Wi-Fi for easy management and control whenever you are on the vessel.

1. Connect an Ethernet cable from the Management LAN port on the front of the ACU to the LAN port of PC. The network connection is established automatically.
2. Bring the Wi-Fi Dongle located in the ACU package. Plug the Wi-Fi Dongle into the USB port on the rear of the ACU.



Figure: Rear Panel Wi-Fi Dongle Connection



3. Use the following IP address to access Intellian AptusNX page.
  - **IP Address: 192.168.2.1 (Default)**
4. Log into the AptusNX by typing in User Name and Password information. If this system has not been changed from the factory default:
  - **User Name: intellian**
  - **Password: 12345678**
5. Select the "SETUP" on the main menu then select the "Network" menu. Choose the AP "Enable" button on the "Wi-Fi Access Point Configuration". If you don't want to use Wi-Fi Connection, choose the AP "Disable" button.
6. Check the "SSID (Wi-Fi AP Name)" information.
7. Choose the SSID Broadcast "Enable" button to show the SSID (Wi-Fi AP Name) on the Wi-Fi list.
8. Click the "Apply" button to apply the settings to the system. Then perform the "iARM Save & Reboot" on page 85.
9. After rebooting, connect to the Wi-Fi.

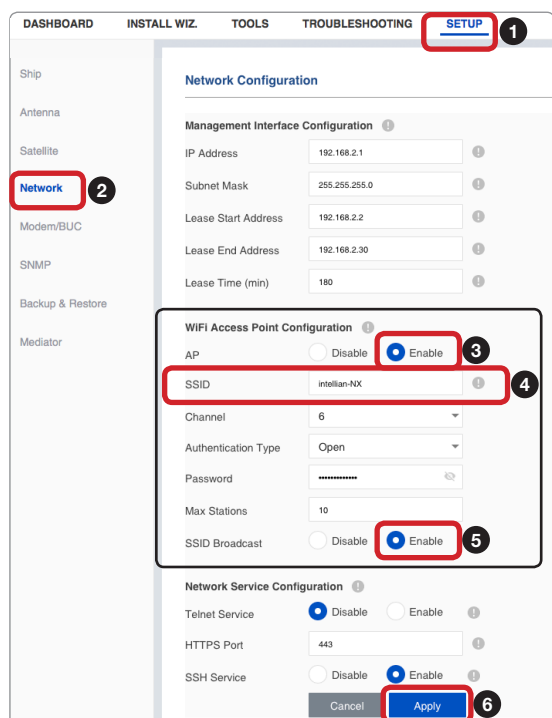

# Operating Install Wizard

## Turning On System

Make sure the antenna has a clear view of the sky. Press the Power button on the front of the Antenna Control Unit (ACU) then wait a few minutes for system startup. Once the antenna finds the satellite, the "POWER" status lights will be lit Green.

## Accessing AptusNX

The network is automatically configured by DHCP without the need for additional PC IP configuration.

1. Connect an Ethernet cable from the Management LAN port on the front of the ACU to the LAN port of PC.
2. The network connection is established automatically.
3. Use the following IP address to access Intellian AptusNX page.
  - **IP Address: 192.168.2.1 (Default)**
4. Log into the AptusNX by typing in User Name and Password information. If this system has not been changed from the factory default:
  - **User Name: intellian**
  - **Password: 12345678**

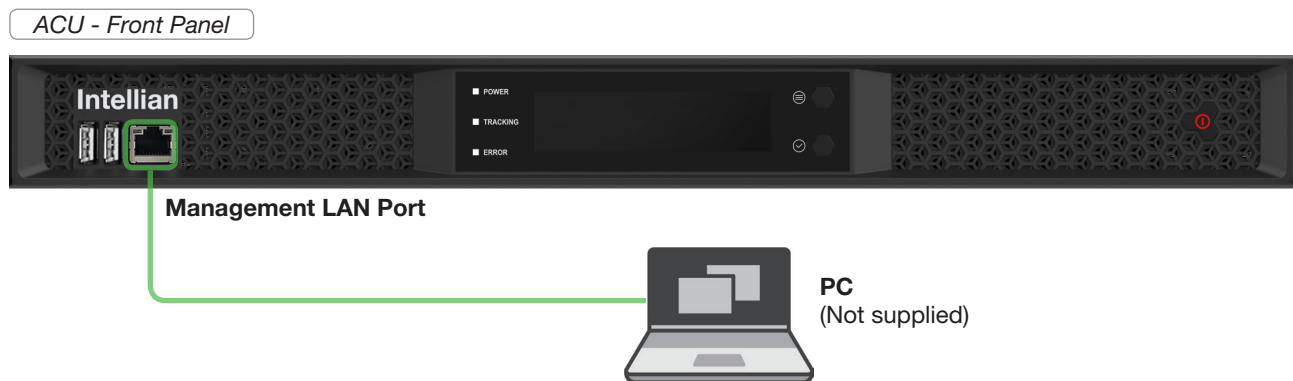
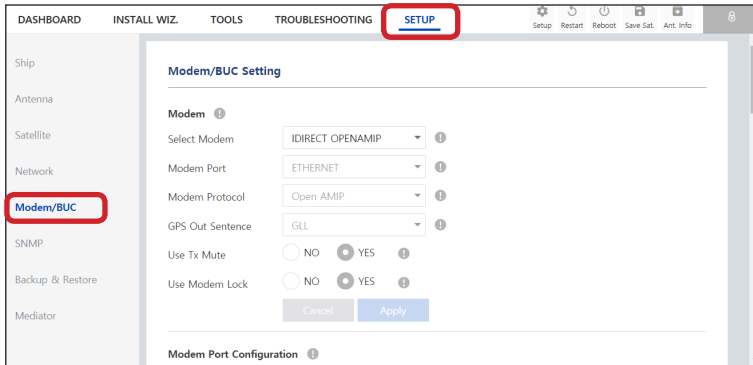

*Figure: Front Panel Management LAN Port Connection*

## Setting up Modem Configuration

Before starting installation wizard, set up the modem configuration.

1. After accessing the AptusNX main page, go to the "SETUP" → "Modem/BUC" on the main menu then follow these steps.



2. Select your modem type from the "Select Modem" drop-down list for loading a pre-configuration for the type of modem used. The settings related to the modem interface will be set automatically once the modem type is selected. When you select "USER SETTING", the other settings can be changed independently. Check the "Apply" button.

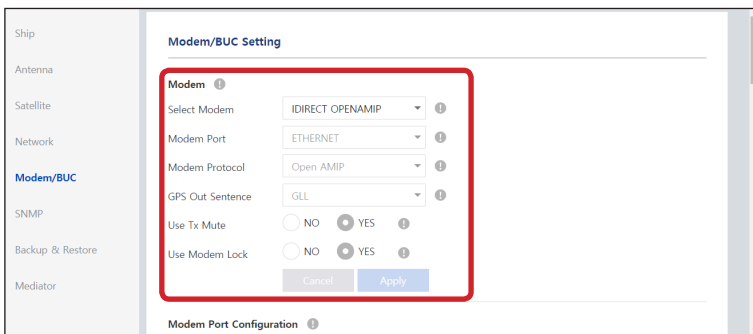

3. Enter the modem setting values to configure the modem. Refer to the option file supplied from the service provider. Check the "Apply" button.

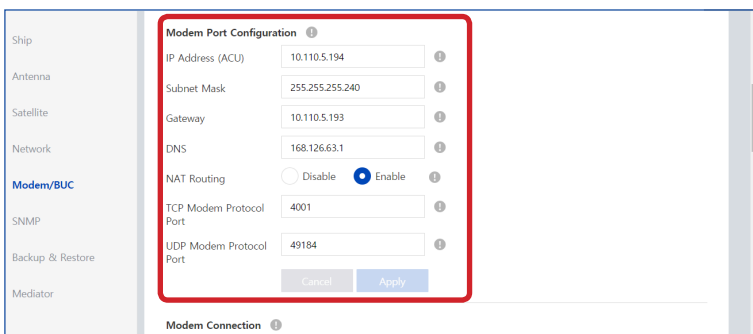



- When clicking the "Apply" button after entering the modem settings, this pop-up message will appear. If you want to automatically save and reboot the system, select the checkbox and click the "Confirm" button. The system will perform the "iARM Save & Reboot" automatically.

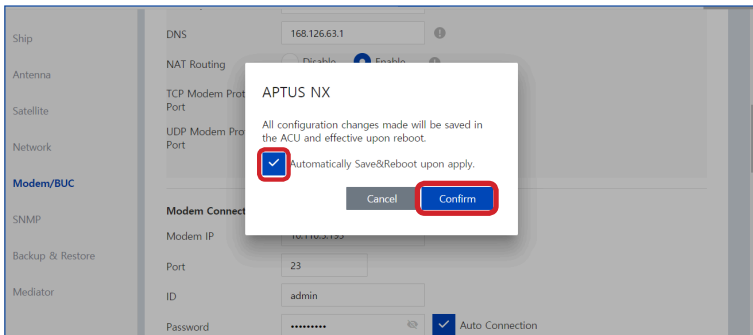

- After rebooting, Log into the AptusNX again.
- Go back to the "SETUP" → "Modem/BUC" → "Modem Connection" menu. Enter the modem connecting values. Check the "Connect" button. The antenna system will communicate to modem automatically. You can check the connected modem name on the screen.

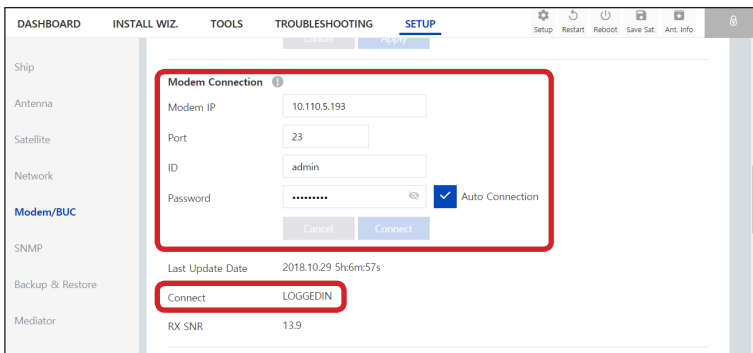

## Starting Install Wizard

The Install Wizard will guide you through the steps of setting up the antenna system for commissioning. We highly recommend using this wizard to complete your installation and commissioning the system. You can choose to exit the wizard at any time by clicking the Finish button. You can also skip a step by clicking the Next button. However, it is recommended to follow the procedure for the initial commissioning. Before you start, please make sure the basic device connections (antenna, modem, etc) are connected to ACU properly. This wizard includes a brief explanation of the purpose and action buttons to set the values. After accessing the AptusNX main page, go to the "INSTALL WIZ." on the main menu then follow these steps.



**NOTE**

The detailed description of each function is written on the "Using AptusNX" on page 65.

NOTE

✓ **Welcome Page**

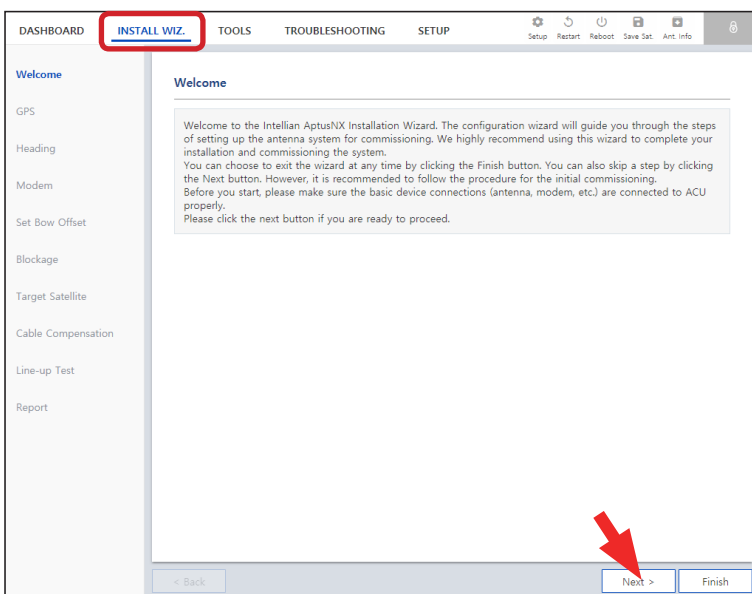

Description

Displays the welcome message. Click the "Next" button to start.

✓ **Step 1: GPS**

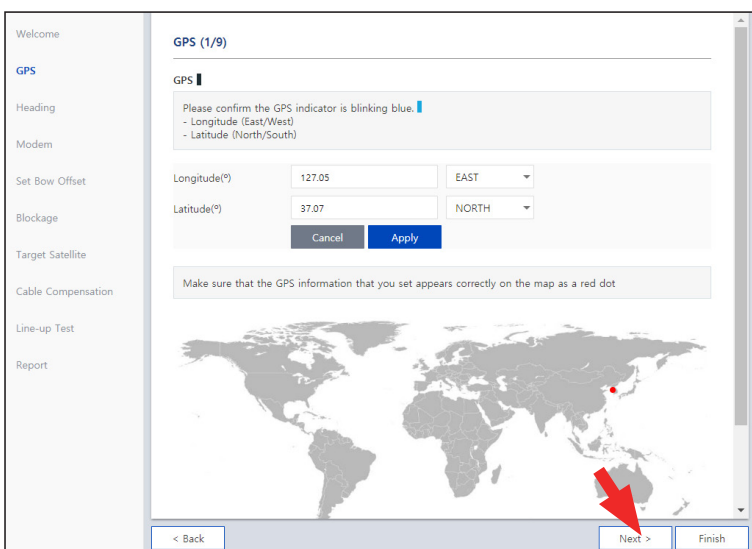

Description

Set the GPS position of the vessel for searching for a satellite. Check the GPS status connected to the antenna system. The indicator right of the title shows the GPS status. Please confirm the GPS indicator is Blue (blinking).

- Blue (blinking): the system received a correct GPS signal.
- Red: the GPS signal is abnormal or the received value is incorrect (Error).
- Black: the system has not received a GPS signal. You can enter the GPS value manually to set the GPS position.

If you have no problems, click the "Next" button.

✓ **Step 2: Heading**

Description

Set the ship's heading device. Choose the device type from the "Current Device" drop-down list. The indicator right of the title shows the device connection status.

- Blue: a ship's heading device is connected.
- Black: a ship's heading device is not connected.

If you have no problems, click the "Next" button.

✓ **Step 3: Modem**

Description

Select your modem type from the "Select Modem" drop-down list for loading a pre-configuration for the type of modem used. The settings related to the modem interface will be set automatically once the modem type is selected. When you select "USER SETTING" the other settings can be changed independently.

If you have no problems, click the "Next" button.

✓ **Step 4: Set Bow Offset**

For setting bow offset, a trackable satellite must be selected. There are two satellite tracking methods. Select the desired tracking type. When Antenna tracks the selected satellite, the bow offset will be set up automatically pbased on the GPS information.

**(Option 1: Using Beam Switch Type)**

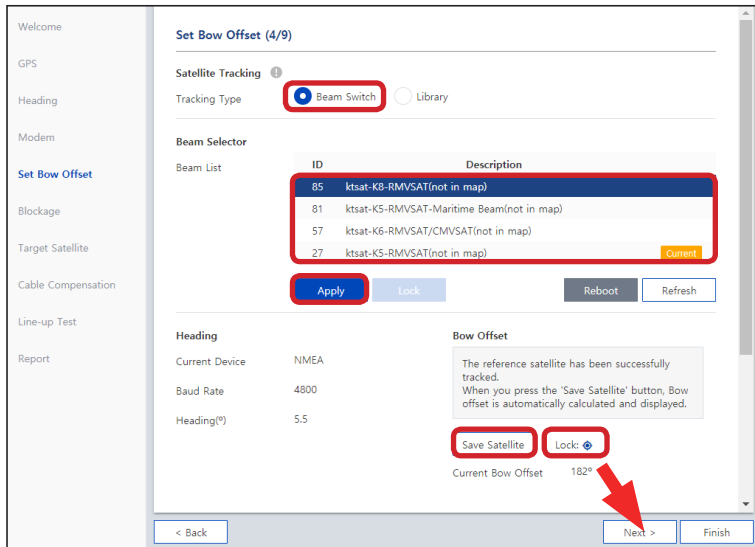

Description

- **Step 1:** choose the "Beam Switch" button on the "Tracking Type".
- **Step 2:** select a satellite in beam list then click the "Apply" button.

Please wait until antenna terminal is tracking the satellite. The bow offset will be set up automatically.

- **Step 3:** check the "Lock On" mark and click the "Save Satellite" button in the "Bow Offset" menu to save the bow offset information to ACU.

If you have no problems, click the "Next" button.

**(Option 2: Using Library Type)**

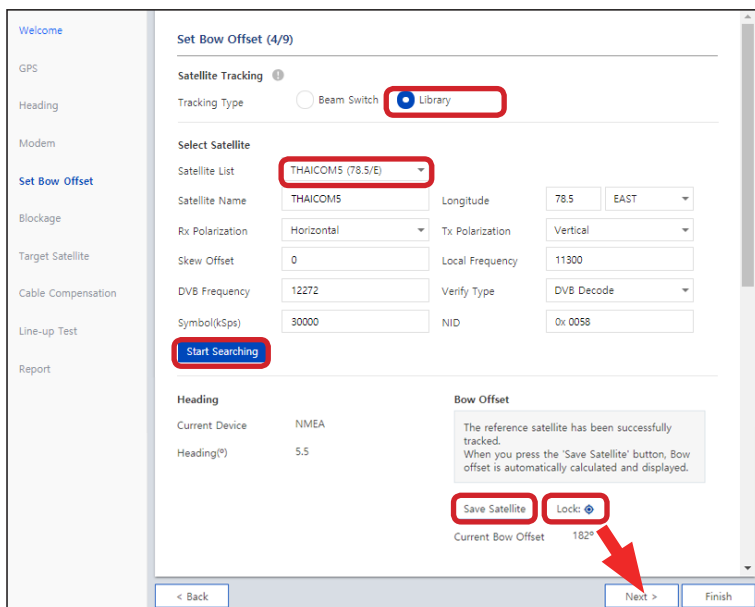

Description

- **Step 1:** choose the "Library" button on the "Tracking Type".
- **Step 2:** select a satellite in satellite library list then click the "Start Searching" button.

Please wait until antenna terminal is tracking the satellite. The bow offset will be set up automatically.

- **Step 3:** check the "Lock On" mark and click the "Save Satellite" button in the "Bow Offset" menu to save the bow offset information to ACU.

If you have no problems, click the "Next" button.

✓ **Step 5: Blockage**

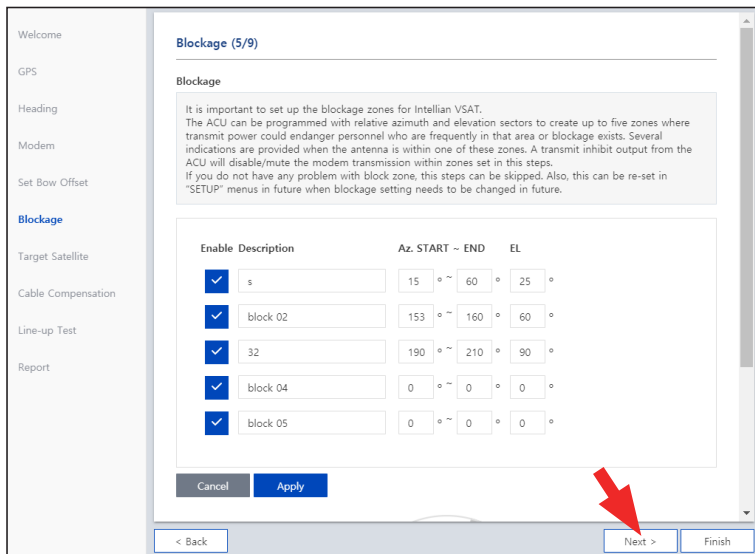

Description

It is important to set up the blockage zones for Intellian VSAT. The ACU can be programmed with relative azimuth and elevation sectors to create up to five zones where transmit power could endanger personnel who are frequently in that area or blockage exists. The "AZ Start" is where the relative azimuth starts and the "AZ End" is where the relative azimuth ends (Range: 0 ~ 360). The "EL" is where the elevation block starts (Range: 0 ~ 90).

If you have no problems, click the "Next" button.

✓ **Step 6: Target Satellite**

Sets the target satellite that you want to track. There are two methods for selecting a target satellite.



**NOTE**

The following images in this step show when the system is using the Open AMIP modem. In case of using other modems, refer to the "Modem/BUC Setting" on page 101 for more details.

**(Option 1: Using Controlled by Modem)**

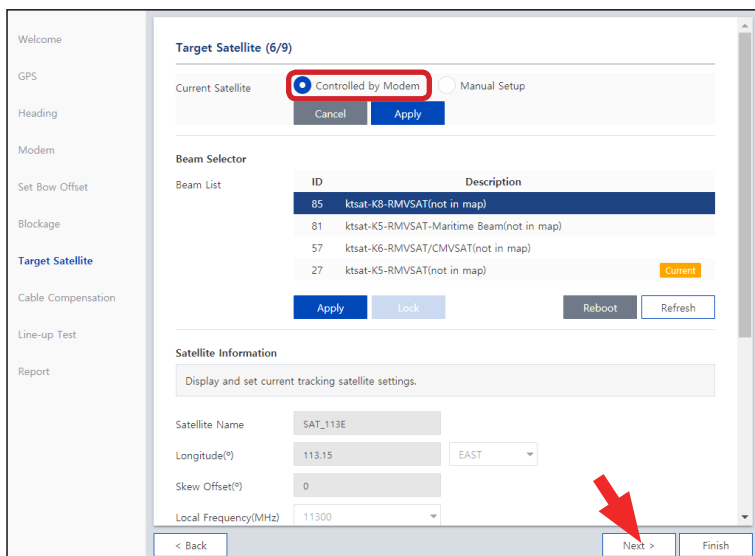

Description

This method is recommended.

When you already set the modem connection in the previous step (Step 3: Modem), the "Controlled by Modem" button on the "Current Satellite" is selected and current satellite information and NBD information is displayed automatically.

If you have no problems, click the "Next" button.

**(Option 2: Using Manual Setup)**

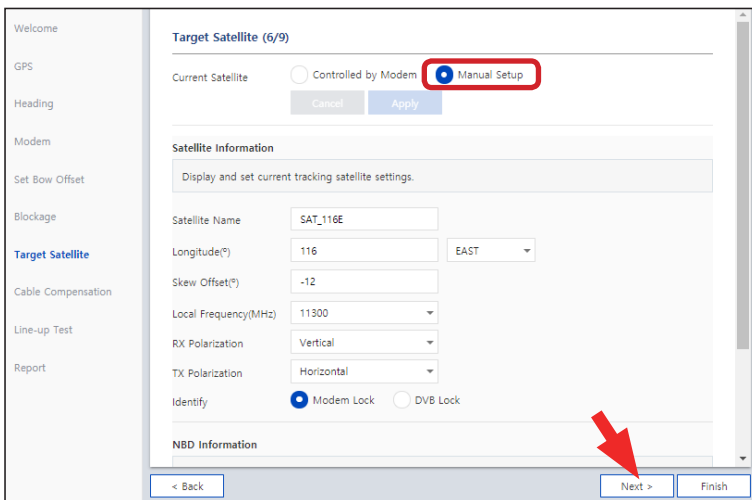

Description

When you did not set the modem connection, select the "Manual Setup" button and enter the satellite information and NBD information manually to track a satellite. Click the "Apply" button.

If you have no problems, click the "Next" button.

**✓ Step 7: Cable Compensation**

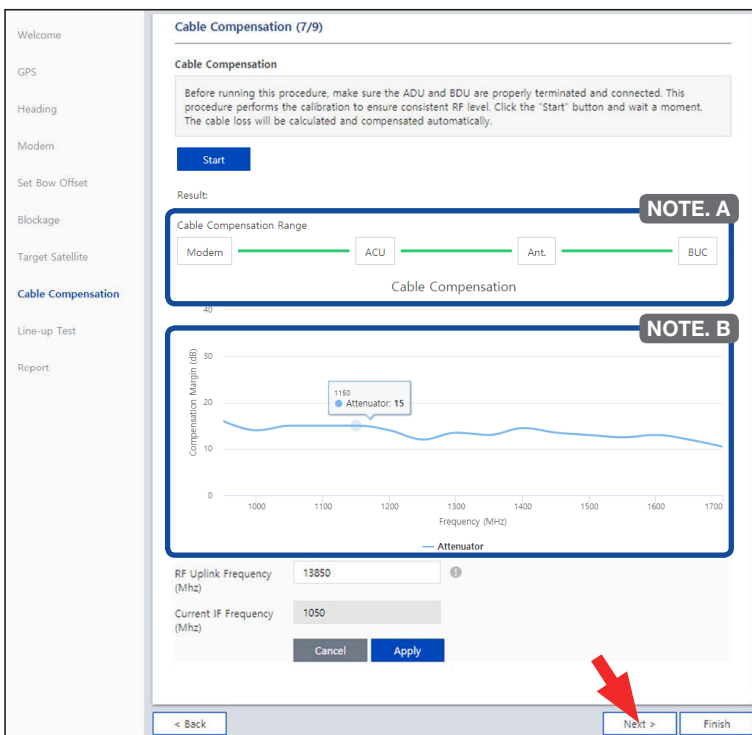

Description

Before running this procedure, make sure the ADU and BDU are properly terminated and connected. This procedure performs the calibration to ensure consistent RF level. Click the "Start" button and wait for a moment. The cable loss will be calculated and compensated automatically. The progress of the cable compensation of a connected device is shown in green. The result of the compensation is displayed as a graph. You can adjust the frequency value.

If you have no problems, click the "Next" button.

**NOTE. A**

The "Cable Compensation Range" is determined by the condition of installation (Modem, BUC). There exist four cases of cable compensation as follows.



| Case | Modem*             | BUC M&C** | Compensation Method   | Compensation path                               |
|------|--------------------|-----------|---|---|
| 1    | iDirect            | O         | IF signal Source: <b>iDirect</b><br>Output Power monitor: <b>BUC M&amp;C</b>    | Full path Calibration                           |
| 2    | iDirect            | X         | IF signal Source: <b>iDirect</b><br>Output Power monitor: <b>Stacker</b>        | Exclude calibration:<br>BUC                     |
| 3    | iDirect            | O         | IF signal Source: <b>De-stacker</b><br>Output Power monitor: <b>BUC M&amp;C</b> | Exclude calibration:<br>Modem to ACU Cable      |
| 4    | Not use<br>iDirect | X         | IF signal Source: <b>De-stacker</b><br>Output Power monitor: <b>Stacker</b>     | Exclude calibration:<br>Modem to ACU Cable, BUC |

\*Modem: iDirect X5, X7 Series which are able to access Telnet and support CLI.

\*\*BUC: NJRC, Terrasat products which have M&C function.

**NOTE. B**

The "Attenuator Graph" displays attenuator values corresponding to the frequency.

- Frequency Range: 950 ~ 1700 MHz(@ 50 MHz step)
- Attenuator Range: 0 ~ 31.5 dB

✓ **Step 8: Line-up Test**

Perform a line-up test by the satellite operator to confirm antenna performance and operation status.

**(Option 1: Using iDirect Open AMIP Modem)**

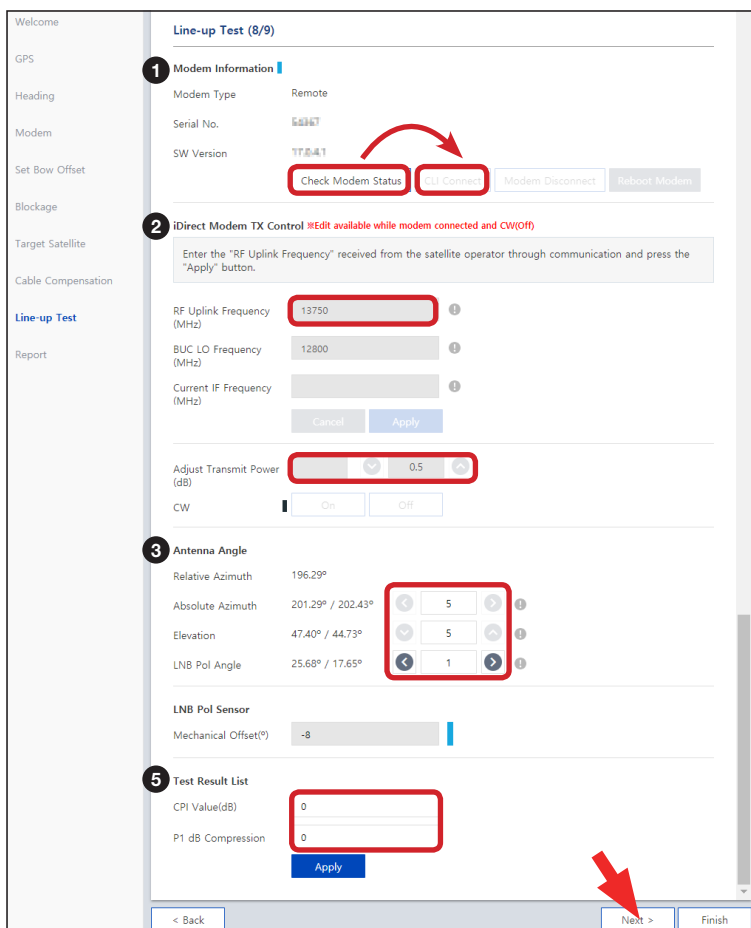

Description

1. Check modem status for connection readiness by clicking the "**Check Modem Status**" button. Then connect to iDirect Open AMIP modem by clicking the "**CLI Connect**" button.
2. Enter the "**RF Uplink Frequency**" received from the satellite operator through communication and click the "**Apply**" button. *This menu can be edited when the antenna is connected to iDirect Open AMIP modem and the CW is off.*
3. Adjust the "**Transmit Power**" of the frequency using the arrow keys which increases or decreases by 0.5dBm.
4. Adjust the "**Antenna Angle**".
5. Enter the "**Test Result**" value received from the satellite operator and click the "**Apply**" button.

If you have no problems, click the "Next" button.

Refer to the following table for a detailed explanation of each menu.

| No. | Item                     | Description  |
|-----|--------------------------|--|
| ①   | Modem Information        | <p>Checks the iDirect Open AMIP modem information. The indicator right of the title shows the device connection status. (Blue: a iDirect Open AMIP modem is connected. Black: a iDirect Open AMIP modem is not connected.)</p> <ul style="list-style-type: none"> <li>• Modem Type: displays the iDirect Open AMIP modem type.</li> <li>• Serial No.: displays the iDirect Open AMIP modem's serial number.</li> <li>• SW Version: displays the iDirect Open AMIP modem's sw version.</li> <li>- Check Modem Status: before the CLI connection, Check modem status for connection readiness by clicking the "Check Modem Status" button.</li> <li>- CLI Connect : connects to iDirect Open AMIP modem by clicking the "CLI Connect" button.</li> <li>- CLI Disconnect: disconnects to iDirect Open AMIP modem by clicking the "CLI Disconnect" button.</li> </ul>  |
| ②   | iDirect Modem TX Control | <p>Adjusts the modem frequency to receive optimal signal. This menu can be edited when the antenna is connected to iDirect Open AMIP modem and the CW is off. Click the "Apply" button to apply the settings to the system.</p> <ul style="list-style-type: none"> <li>• RF Uplink Frequency (MHz): enters the RF uplink frequency received from the satellite operator through communication.</li> <li>• BUC LO Frequency (MHz): the BUC LO frequency is applied automatically. The value is fixed according to the satellite band.</li> <li>• Current IF Frequency (MHz): the current IF frequency is applied automatically. The value is "RF Uplink Frequency" value - "BUC LO Frequency".</li> </ul> <p>The following menus are performed to adjust the transmit power of the frequency.</p> <ul style="list-style-type: none"> <li>• Adjust Transmit Power: adjusts the power calibration value using the arrow keys which increases or decreases by 0.5dBm.</li> <li>• CW: selects whether or not to use the modulation function (On or Off). The indicator right of the title shows the CW status. (Blue: a CW is on. Black: a CW is off.) To edit the details of the iDirect Modem TX Control menu, you must keep this function is off.</li> </ul> |
| ③   | Antenna Angle            | <p>Adjusts the antenna angle to receive optimal signal.</p> <ul style="list-style-type: none"> <li>• Relative Azimuth: displays the relative azimuth angle.</li> <li>• Absolute Azimuth: adjusts the absolute azimuth angle using the arrow keys.</li> <li>• Elevation: adjusts the elevation angle using the arrow keys.</li> <li>• LNB Pol Angle: adjusts the LNB Pol angle using the arrow keys.</li> </ul>   |
| ④   | LNB Pol Sensor           | <p>Displays the Mechanical Offset value of the LNB Pol Sensor. The indicator right of the title shows the LNB Pol Sensor status. (Blue: the LNB pol sensor is on. Black: the LNB pol sensor is off.)</p> <ul style="list-style-type: none"> <li>• Mechanical Offset: displays the mechanical offset value of the LNB Pol Sensor.</li> </ul>  |
| ⑤   | Test Result List         | <p>Enters the test result value received from the satellite operator.</p> <ul style="list-style-type: none"> <li>• CPI Value(dB): enters the CPI value.</li> <li>• P1 dB Compression: enters the P1 dB compression.</li> </ul>   |



**(Option 2: Using Other Modems)**

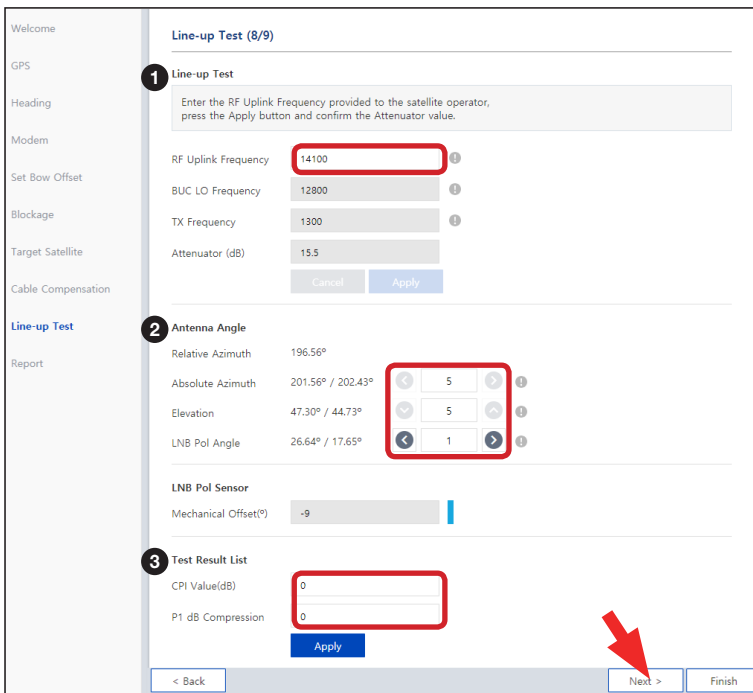

Description

1. Enter the "RF Uplink Frequency" received from the satellite operator through communication and click the "Apply" button.
  2. Adjust the "Antenna Angle".
  3. Enter the "Test Result" value received from the satellite operator.
- If you have no problems, click the "Next" button.

Refer to the following table for a detailed explanation of each menu.

| No. | Item                     | Description   |
|-----|--------------------------|---|
| ①   | iDirect Modem TX Control | <p>Adjusts the modem frequency to receive optimal signal. Click the "Apply" button to apply the settings to the system.</p> <ul style="list-style-type: none"> <li>• RF Uplink Frequency (MHz): enters the RF uplink frequency received from the satellite operator through communication.</li> <li>• BUC LO Frequency (MHz): the BUC LO frequency is applied automatically. The value is fixed according to the satellite band.</li> <li>• TX Frequency: the TX frequency is applied automatically. The value is "RF Uplink Frequency" value - "BUC LO Frequency".</li> <li>• Attenuator (dB): the attenuator is applied automatically.</li> </ul> |
| ②   | Antenna Angle            | <p>Adjusts the antenna angle to receive optimal signal.</p> <ul style="list-style-type: none"> <li>• Relative Azimuth: adjusts the relative azimuth angle.</li> <li>• Absolute Azimuth: adjusts the absolute azimuth angle.</li> <li>• Elevation: adjusts the elevation angle.</li> <li>• LNB Pol Angle: adjusts the LNB Pol angle.</li> </ul>  |
| ③   | Test Result List         | <p>Enters the test result value received from the satellite operator.</p> <ul style="list-style-type: none"> <li>• CPI Value(dB): enters the CPI value.</li> <li>• P1 dB Compression: enters the P1 dB compression.</li> </ul>  |

✓ **Step 9: Report**



**NOTE**

**NOTE**

The following image in this step shows when the system is using the Open AMIP modem. In case of using other modems, the report items displayed may vary with the image below.

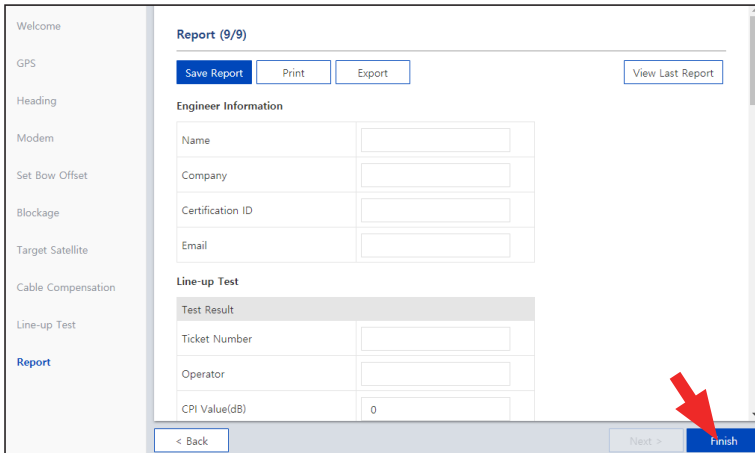

Description

Displays the configuration report (System Information, ACU Parameter, Modem Parameter, Line-up Test).

You can save the results to the ACU by clicking the "Save Report" button and print this page by clicking the "Print" button and download the report file (.json) by clicking the "Export" button.

Click the "View Last Report" button to check the recently saved report information including the save date and time.

After completing the steps, click the "Finish" button.

# Operating ACU

## Introduction

### Antenna Control Unit (ACU)

The Antenna Control Unit (ACU) controls the various settings of the antenna.

### ACU Front Panel

The following figure shows the ACU's front panel.

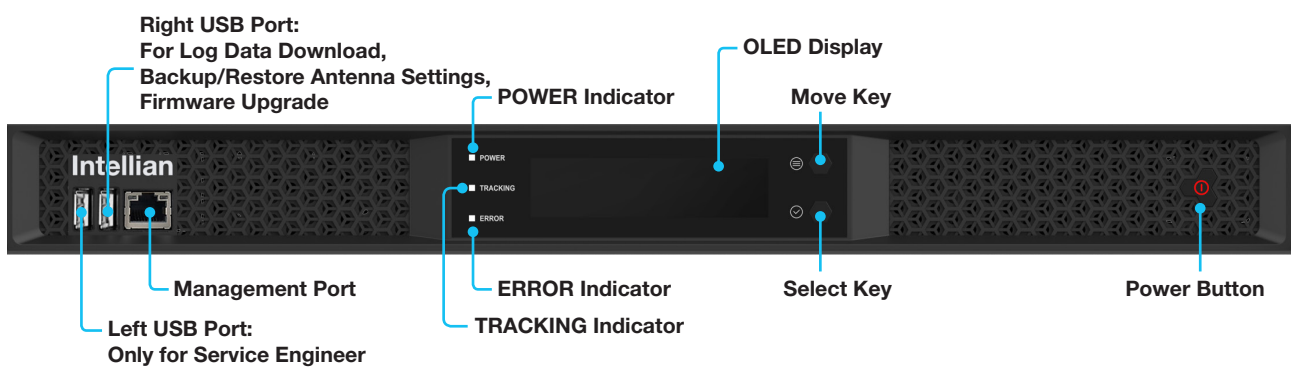

Figure: Name of ACU Front Panel

The following table shows the function of each touch key.

| Touch key    | Function                     |
|--------------|------------------------------|
| Power Button | Power on/off the ACU.        |
| Move Key     | Moves to the desired screen. |
| Select Key   | Selects the desired screen.  |

The following table shows status indicators on the face of ACU.

| LED Display | Color        | Description                      |
|-------------|--------------|----------------------------------|
| POWER       | Steady Green | The ACU is powered on.           |
|             | Off          | The ACU is powered off.          |
| ERROR       | Steady Red   | The antenna is faulty.           |
| TRACKING    | Steady Green | The antenna is in tracking mode. |

## ACU Display Menu

The following figure shows the ACU display menu.

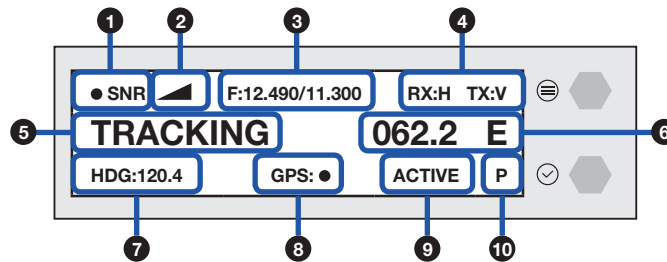

The following table shows the function of each touch key.

| No. | Item                                     | Description   |
|-----|--|---|
| ①   | Satellite Lock                           | Displays the satellite lock status.   |
| ②   | Signal Level                             | Displays the antenna signal level.  |
| ③   | Frequency Information (Target/LNB Local) | Displays the frequency information (Target / LNB Local).  |
| ④   | Polarization                             | Displays the Rx/Tx polarization (H: Horizontal / V: Vertical).  |
| ⑤   | Antenna Status                           | Displays the antenna status (Tracking / Search / Setup).  |
| ⑥   | Target Satellite                         | Displays the target satellite (E: East / W: West).  |
| ⑦   | Heading Information                      | Displays heading information (e.g. gyrocompass).  |
| ⑧   | GPS Lock                                 | Displays the GPS lock status.   |
| ⑨   | Antenna Active State                     | <p><i>This function is available when using Dual Antenna System.</i></p> <p>Displays the antenna's active state. The active antenna (either primary or secondary antenna) is communicating (Tx/Rx) with a satellite.</p> <ul style="list-style-type: none"> <li>ACTIVE: the active antenna is displayed as "ACTIVE" on the ACU screen.</li> </ul>   |
| ⑩   | Antenna Role Status                      | <p><i>This function is available when using Dual Antenna System.</i></p> <p>Displays the antenna's role as primary antenna or secondary antenna.</p> <ul style="list-style-type: none"> <li>P (Primary): when running the master ACU, which is connected to the modem and the gyrocompass, select the primary role. The master ACU is assigned and operated as the primary antenna, which will communicate with the target satellite.</li> <li>S (Secondary): when running the slave ACU, select the secondary role. The secondary ACU is assigned and operated as the secondary antenna, which will be on standby and ready to assume primary antenna role to provide better service in the event of tracking failure or low signal level status.</li> </ul> |

# Startup

With the system is installed and power is applied, the ACU display will show the following sequence.

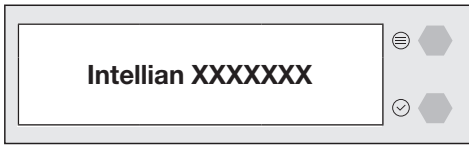

✓ **Startup**  
 ("Intellian XX..." will appear. The "XX..." is the model name.)

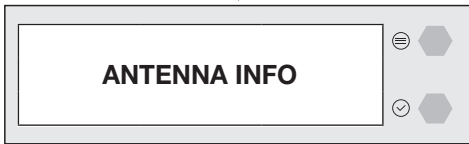

✓ **Initialize Antenna Information**

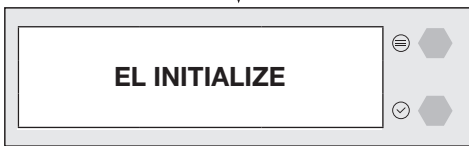

✓ **Initialize Elevation Angle**

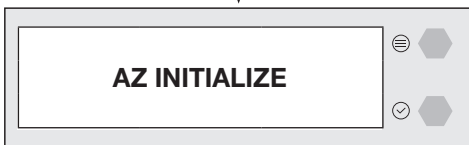

✓ **Initialize Azimuth Angle**

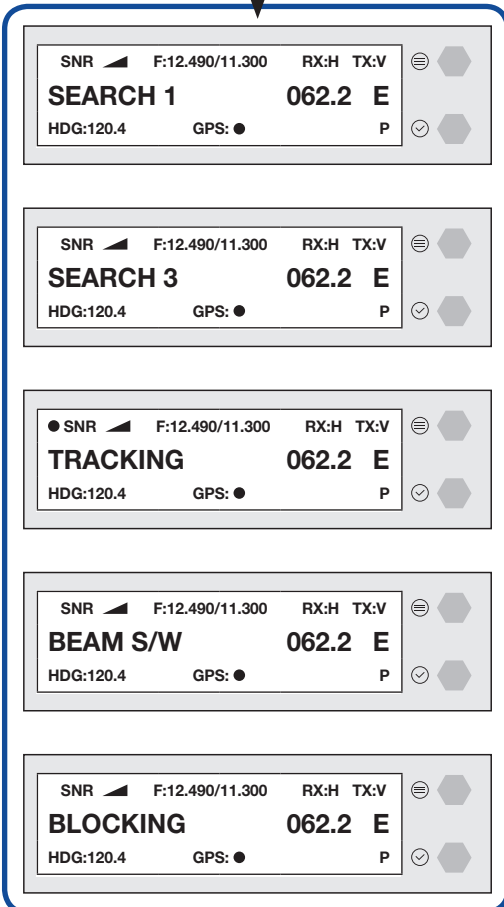

✓ **Antenna's Status**  
 (in Search 1 (Global Search), Search 3 (Local Search), Tracking, Beam Switching, Blocking)

When the antenna is controlled by AptusNX, the ACU displays the control mode status.

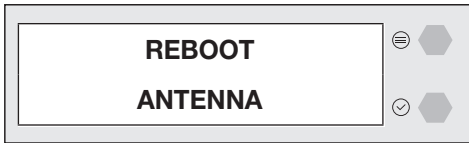

✓ **Control Mode Status**  
(in Reboot Mode, Setup Mode, Test Mode)

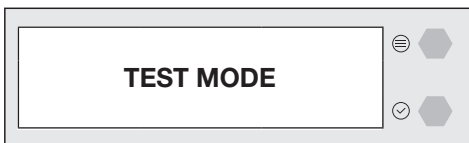
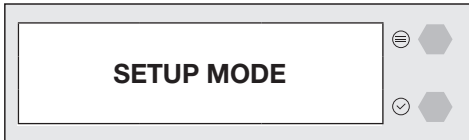

If the antenna is not communicating with ACU, the "COMMUNICATION ERROR" message will appear.

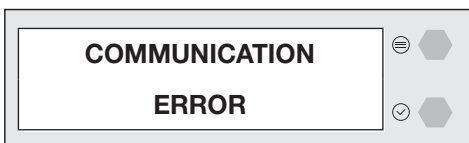

# Diagnosis

Executes antenna Diagnosis test and shows the real-time diagnosis result.

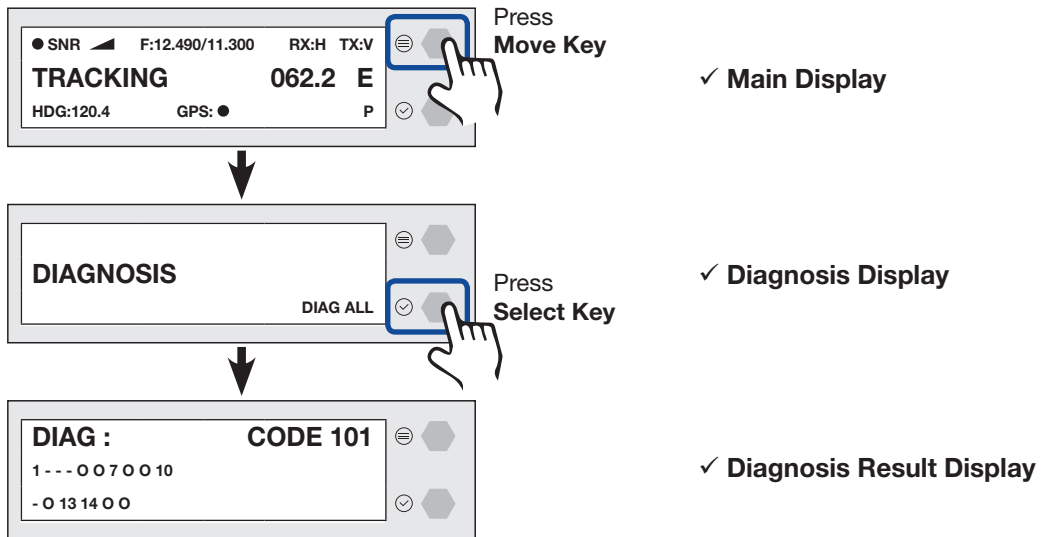

Refer to the diagnosis codes for the test results.

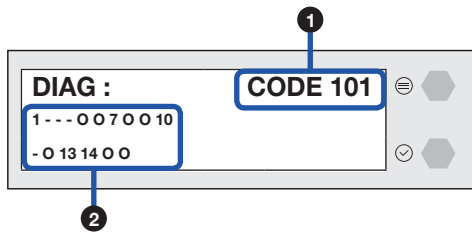

| No.                   | Item  | Description   |                       |                                    |                 |   |     |                             |     |                               |     |                                 |     |               |     |               |     |                            |     |               |     |               |     |                          |     |                              |     |               |     |                              |     |                          |     |               |     |                            |
|-----------------------|---|---|-----------------------|------------------------------------|-----------------|---|-----|-----------------------------|-----|-------------------------------|-----|---------------------------------|-----|---------------|-----|---------------|-----|----------------------------|-----|---------------|-----|---------------|-----|--------------------------|-----|------------------------------|-----|---------------|-----|------------------------------|-----|--------------------------|-----|---------------|-----|----------------------------|
| ①                     | Diagnosis Code  | <p>Displays the diagnosis code.</p> <table border="1" data-bbox="544 315 1370 1037"> <thead> <tr> <th data-bbox="544 315 647 351">Code</th> <th data-bbox="647 315 1370 351">Test</th> </tr> </thead> <tbody> <tr> <td data-bbox="544 351 647 432">101</td> <td data-bbox="647 351 1370 432">The data communication between the antenna and the ACU is tested.</td> </tr> <tr> <td data-bbox="544 432 647 470">102</td> <td data-bbox="647 432 1370 470">The azimuth axis is tested.</td> </tr> <tr> <td data-bbox="544 470 647 508">103</td> <td data-bbox="647 470 1370 508">The elevation axis is tested.</td> </tr> <tr> <td data-bbox="544 508 647 546">104</td> <td data-bbox="647 508 1370 546">The cross-level axis is tested.</td> </tr> <tr> <td data-bbox="544 546 647 584">105</td> <td data-bbox="647 546 1370 584">Not Available</td> </tr> <tr> <td data-bbox="544 584 647 622">106</td> <td data-bbox="647 584 1370 622">Not Available</td> </tr> <tr> <td data-bbox="544 622 647 660">107</td> <td data-bbox="647 622 1370 660">The rate sensor is tested.</td> </tr> <tr> <td data-bbox="544 660 647 698">108</td> <td data-bbox="647 660 1370 698">Not Available</td> </tr> <tr> <td data-bbox="544 698 647 736">109</td> <td data-bbox="647 698 1370 736">Not Available</td> </tr> <tr> <td data-bbox="544 736 647 775">110</td> <td data-bbox="647 736 1370 775">The LNB / NBD is tested.</td> </tr> <tr> <td data-bbox="544 775 647 813">111</td> <td data-bbox="647 775 1370 813">The LNB pol motor is tested.</td> </tr> <tr> <td data-bbox="544 813 647 851">112</td> <td data-bbox="647 813 1370 851">Not Available</td> </tr> <tr> <td data-bbox="544 851 647 889">113</td> <td data-bbox="647 851 1370 889">The antenna power is tested.</td> </tr> <tr> <td data-bbox="544 889 647 927">114</td> <td data-bbox="647 889 1370 927">The ACU power is tested.</td> </tr> <tr> <td data-bbox="544 927 647 965">115</td> <td data-bbox="647 927 1370 965">Not Available</td> </tr> <tr> <td data-bbox="544 965 647 1003">116</td> <td data-bbox="647 965 1370 1003">The home sensor is tested.</td> </tr> </tbody> </table> | Code                  | Test                               | 101             | The data communication between the antenna and the ACU is tested. | 102 | The azimuth axis is tested. | 103 | The elevation axis is tested. | 104 | The cross-level axis is tested. | 105 | Not Available | 106 | Not Available | 107 | The rate sensor is tested. | 108 | Not Available | 109 | Not Available | 110 | The LNB / NBD is tested. | 111 | The LNB pol motor is tested. | 112 | Not Available | 113 | The antenna power is tested. | 114 | The ACU power is tested. | 115 | Not Available | 116 | The home sensor is tested. |
| Code                  | Test  |   |                       |                                    |                 |   |     |                             |     |                               |     |                                 |     |               |     |               |     |                            |     |               |     |               |     |                          |     |                              |     |               |     |                              |     |                          |     |               |     |                            |
| 101                   | The data communication between the antenna and the ACU is tested. |   |                       |                                    |                 |   |     |                             |     |                               |     |                                 |     |               |     |               |     |                            |     |               |     |               |     |                          |     |                              |     |               |     |                              |     |                          |     |               |     |                            |
| 102                   | The azimuth axis is tested.                                       |   |                       |                                    |                 |   |     |                             |     |                               |     |                                 |     |               |     |               |     |                            |     |               |     |               |     |                          |     |                              |     |               |     |                              |     |                          |     |               |     |                            |
| 103                   | The elevation axis is tested.                                     |   |                       |                                    |                 |   |     |                             |     |                               |     |                                 |     |               |     |               |     |                            |     |               |     |               |     |                          |     |                              |     |               |     |                              |     |                          |     |               |     |                            |
| 104                   | The cross-level axis is tested.                                   |   |                       |                                    |                 |   |     |                             |     |                               |     |                                 |     |               |     |               |     |                            |     |               |     |               |     |                          |     |                              |     |               |     |                              |     |                          |     |               |     |                            |
| 105                   | Not Available   |   |                       |                                    |                 |   |     |                             |     |                               |     |                                 |     |               |     |               |     |                            |     |               |     |               |     |                          |     |                              |     |               |     |                              |     |                          |     |               |     |                            |
| 106                   | Not Available   |   |                       |                                    |                 |   |     |                             |     |                               |     |                                 |     |               |     |               |     |                            |     |               |     |               |     |                          |     |                              |     |               |     |                              |     |                          |     |               |     |                            |
| 107                   | The rate sensor is tested.  |   |                       |                                    |                 |   |     |                             |     |                               |     |                                 |     |               |     |               |     |                            |     |               |     |               |     |                          |     |                              |     |               |     |                              |     |                          |     |               |     |                            |
| 108                   | Not Available   |   |                       |                                    |                 |   |     |                             |     |                               |     |                                 |     |               |     |               |     |                            |     |               |     |               |     |                          |     |                              |     |               |     |                              |     |                          |     |               |     |                            |
| 109                   | Not Available   |   |                       |                                    |                 |   |     |                             |     |                               |     |                                 |     |               |     |               |     |                            |     |               |     |               |     |                          |     |                              |     |               |     |                              |     |                          |     |               |     |                            |
| 110                   | The LNB / NBD is tested.  |   |                       |                                    |                 |   |     |                             |     |                               |     |                                 |     |               |     |               |     |                            |     |               |     |               |     |                          |     |                              |     |               |     |                              |     |                          |     |               |     |                            |
| 111                   | The LNB pol motor is tested.                                      |   |                       |                                    |                 |   |     |                             |     |                               |     |                                 |     |               |     |               |     |                            |     |               |     |               |     |                          |     |                              |     |               |     |                              |     |                          |     |               |     |                            |
| 112                   | Not Available   |   |                       |                                    |                 |   |     |                             |     |                               |     |                                 |     |               |     |               |     |                            |     |               |     |               |     |                          |     |                              |     |               |     |                              |     |                          |     |               |     |                            |
| 113                   | The antenna power is tested.                                      |   |                       |                                    |                 |   |     |                             |     |                               |     |                                 |     |               |     |               |     |                            |     |               |     |               |     |                          |     |                              |     |               |     |                              |     |                          |     |               |     |                            |
| 114                   | The ACU power is tested.  |   |                       |                                    |                 |   |     |                             |     |                               |     |                                 |     |               |     |               |     |                            |     |               |     |               |     |                          |     |                              |     |               |     |                              |     |                          |     |               |     |                            |
| 115                   | Not Available   |   |                       |                                    |                 |   |     |                             |     |                               |     |                                 |     |               |     |               |     |                            |     |               |     |               |     |                          |     |                              |     |               |     |                              |     |                          |     |               |     |                            |
| 116                   | The home sensor is tested.  |   |                       |                                    |                 |   |     |                             |     |                               |     |                                 |     |               |     |               |     |                            |     |               |     |               |     |                          |     |                              |     |               |     |                              |     |                          |     |               |     |                            |
| ②                     | Diagnosis Result  | <ul style="list-style-type: none"> <li>• An example of diagnosis result:           <table border="1" data-bbox="579 1111 842 1189" style="margin-left: 20px;"> <tr> <td style="border: 1px dashed red;">1 - - - 0 0 7 0 0 1 0</td> <td style="border: none;">← Diagnosis Result of Code 101~110</td> </tr> <tr> <td style="border: none;">- 0 1 3 1 4 0 0</td> <td style="border: none;">← Diagnosis Result of Code 111~116</td> </tr> </table> </li> <li>- ' - ' : <b>The test was passed.</b><br/>Code 102, 103, 104 and 111 were passed.</li> <li>- <b>Last 1 or 2 digits of diagnosis code : The test was failed.</b><br/>Code 101, 107, 110, 113 and 114 were failed.</li> <li>- ' 0 ' : <b>The test was not performed.</b><br/>Code 105, 106, 108, 109, 112, 115 and 116 were not performed.</li> </ul>   | 1 - - - 0 0 7 0 0 1 0 | ← Diagnosis Result of Code 101~110 | - 0 1 3 1 4 0 0 | ← Diagnosis Result of Code 111~116                                |     |                             |     |                               |     |                                 |     |               |     |               |     |                            |     |               |     |               |     |                          |     |                              |     |               |     |                              |     |                          |     |               |     |                            |
| 1 - - - 0 0 7 0 0 1 0 | ← Diagnosis Result of Code 101~110                                |   |                       |                                    |                 |   |     |                             |     |                               |     |                                 |     |               |     |               |     |                            |     |               |     |               |     |                          |     |                              |     |               |     |                              |     |                          |     |               |     |                            |
| - 0 1 3 1 4 0 0       | ← Diagnosis Result of Code 111~116                                |   |                       |                                    |                 |   |     |                             |     |                               |     |                                 |     |               |     |               |     |                            |     |               |     |               |     |                          |     |                              |     |               |     |                              |     |                          |     |               |     |                            |



## Antenna Information

Displays the Antenna/ACU serial number, PCU/STAB/ACU/i-ARM Version of the product.

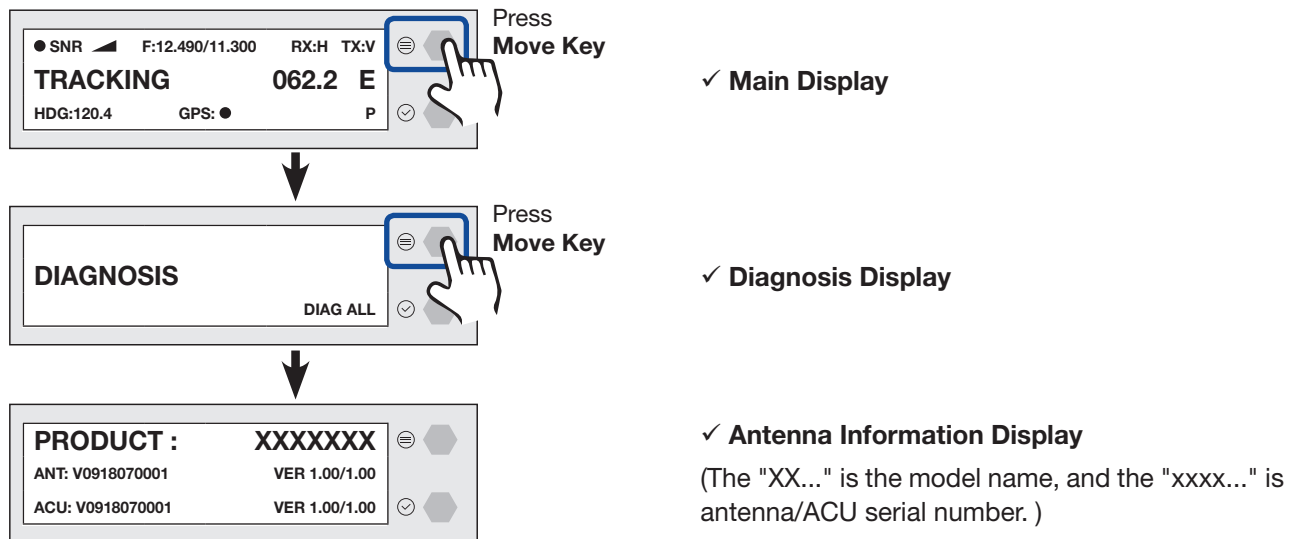

Refer to the Antenna Information display.

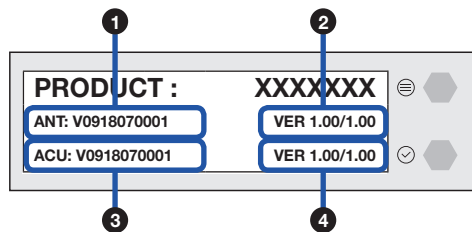

| No. | Item                          | Description  |
|-----|-------------------------------|--|
| ①   | Antenna Serial Number         | Displays the Antenna serial number. The serial number is displayed depending on the product. |
| ②   | PCU Version/<br>STAB Version  | Displays the PCU version / Stabilizer version.   |
| ③   | ACU Serial Number             | Displays the ACU serial number. The serial number is displayed depending on the product.     |
| ④   | ACU Version/<br>i-ARM Version | Displays the ACU version / i-ARM version.  |

## Interface Information

Displays the modem/heading type in use and the network connection status.

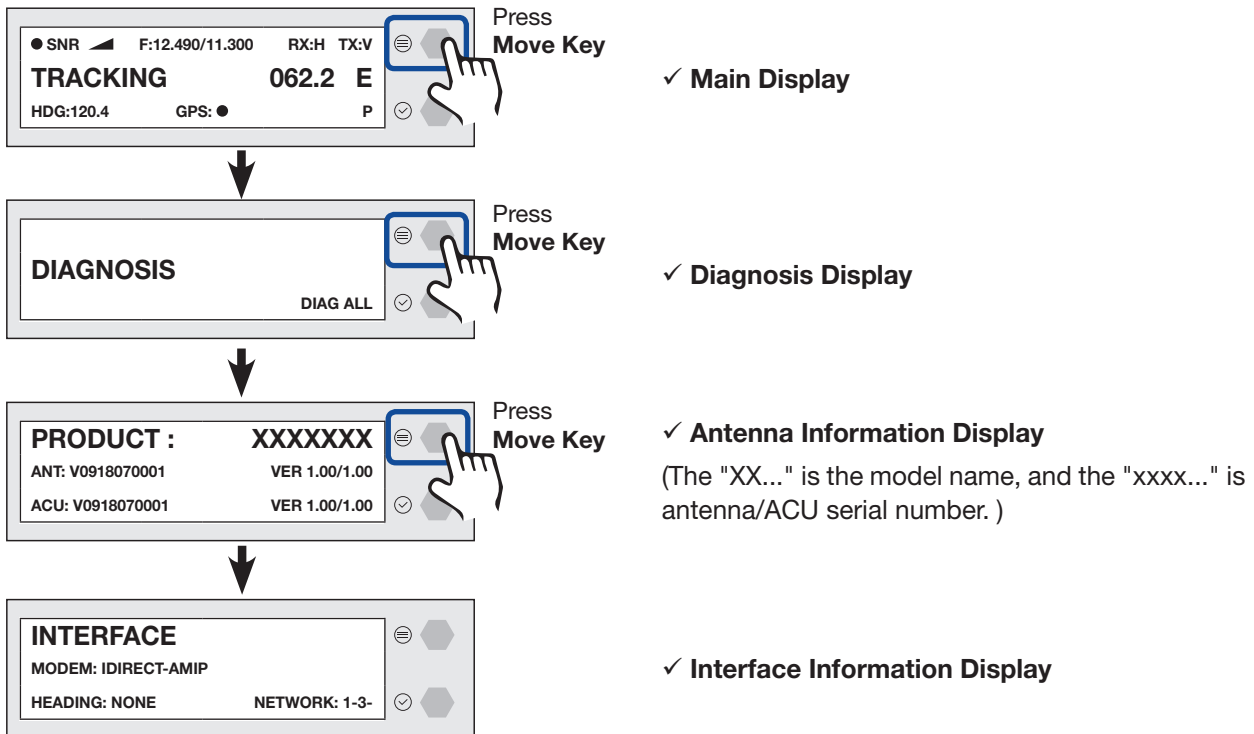

Refer to the Interface Information.

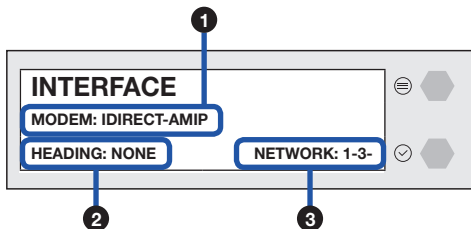

| No. | Item    | Description  |
|-----|---------|--|
| ①   | MODEM   | Displays the modem type in use.<br>(IDIRECT-AMIP, SATLINK-SERIAL, IDIRECT I/O, SATLINK-VACP, NEWTEC AMIP, COMTECH I/O, ELEKTRIKOM AMIP, USER SETTING, COMTECH ROSS, GILAT-SE-II, HUGHES, IP STAR)  |
| ②   | HEADING | Displays the heading type in use (NONE, NMEA0183, STATIC, NMEA2000).   |
| ③   | NETWORK | Displays the network connection status with the ACU. <ul style="list-style-type: none"> <li>• An example of network result: 1-3-</li> <li>- ' - ' : the network is not connected.</li> <li>- ' 1~4 ' : the number (1~4) of connected ACU port to network.</li> </ul> |

## USB Function

To use this function, a USB Memory Stick must be connected to the USB port (the right USB port on the front of the ACU). The USB Function supports the four menus (LOG DOWNLOAD, FIRMWARE UPLOAD, BACKUP TO USB, RESTORE FROM USB). For detailed information about each function, refer to the next page.

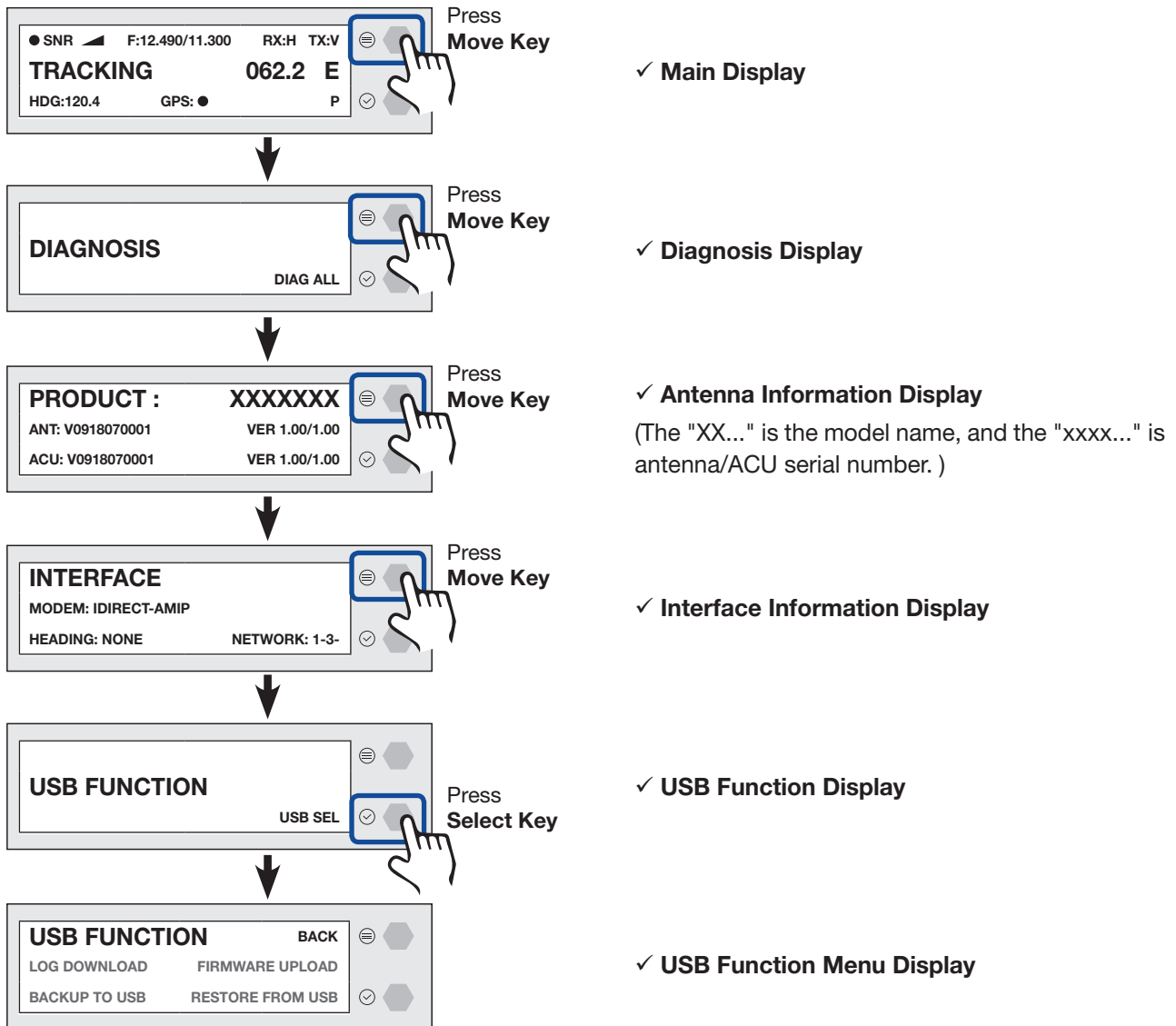

## LOG DOWNLOAD

Downloads all data logs to the USB memory stick

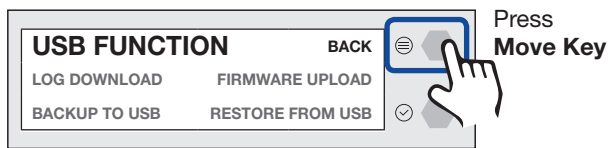

Press  
Move Key

✓ USB Function Menu Display

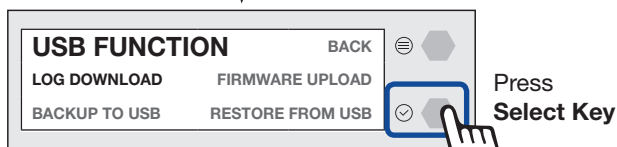

Press  
Select Key



Press  
Move Key

✓ Log Download Menu Display

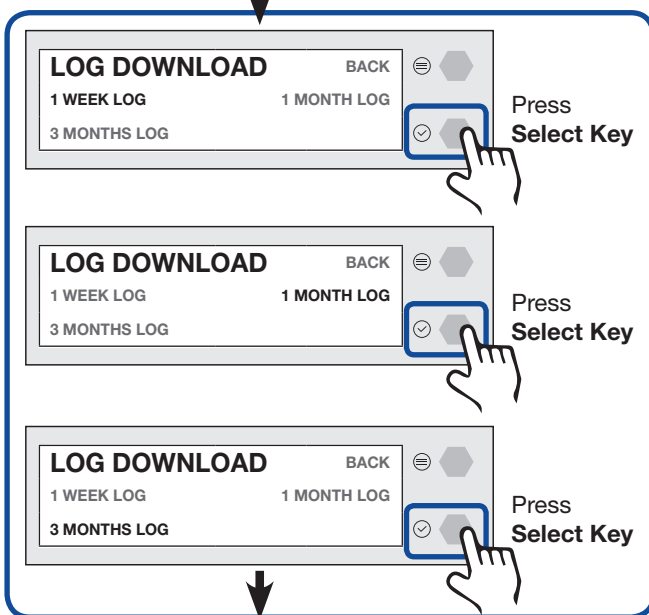

Press  
Select Key

Press  
Select Key

Press  
Select Key

✓ Download Log File to USB

(Select one of three options: 1 WEEK LOG / 1 MONTH LOG / 3 MONTHS LOG)

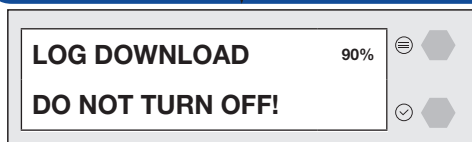

90%

✓ Download Process Display

If there is not enough space on the USB memory stick, the "NOT ENOUGH SPACE" message will appear.

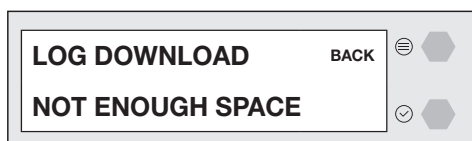

NOTE

### NOTE

When you want to return to the previous display, select the "BACK" option then press the "Select" key.

## FIRMWARE UPLOAD

To use Firmware Upload function, you must follow the folder structure guide to configure the folders properly. It supports up to FAT32. The antenna system is upgraded with the FWP file in the designated folder of a USB memory stick.

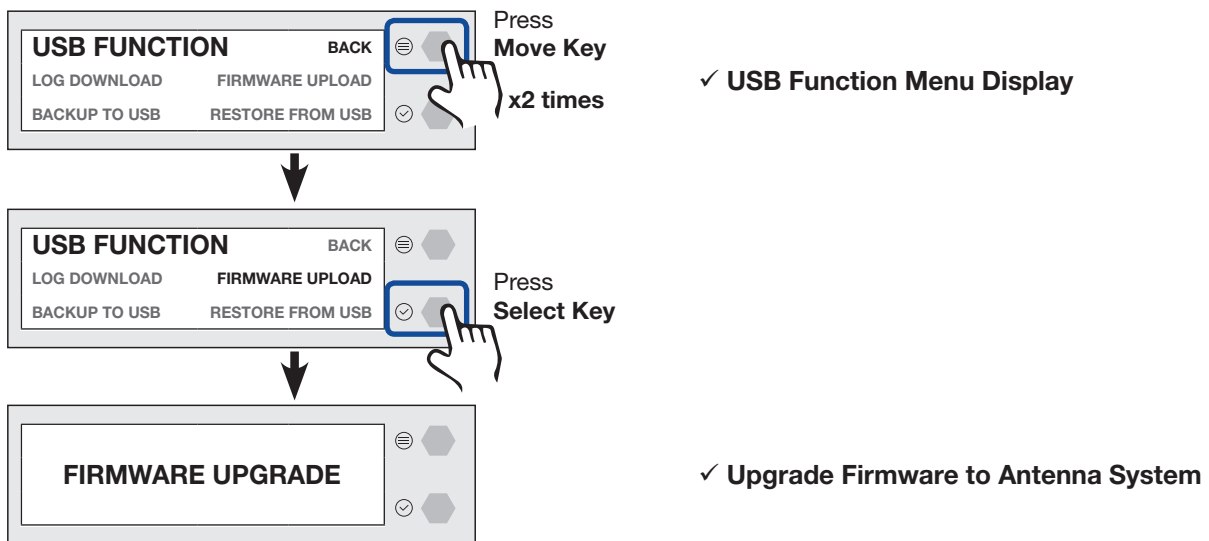
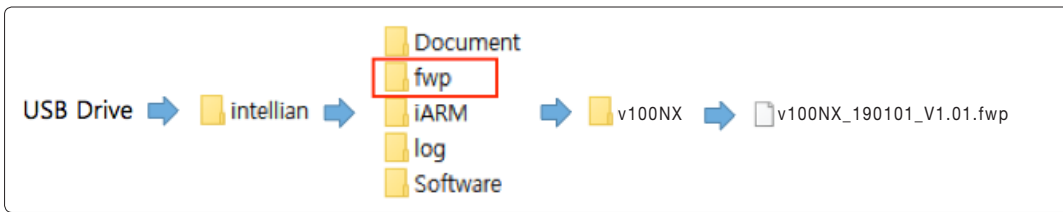

If the firmware file does not match the file format, the "INVALID FILE FORMAT" message will appear.

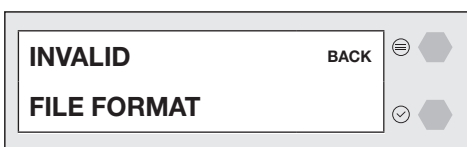

If there is no firmware file on the USB memory stick, the "FILE NOT FOUND" message will appear.

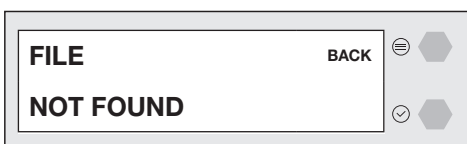

### NOTE

When you want to return to the previous display, select the "BACK" option then press the "Select" key.

NOTE

## BACKUP TO USB

Backs up the antenna setting files to the USB.

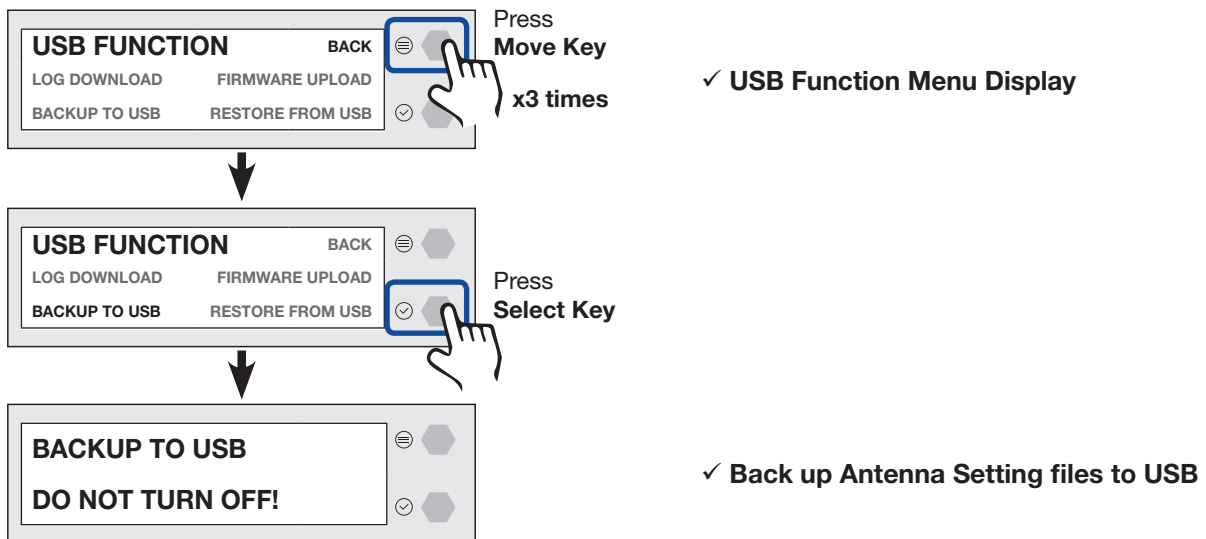

If there is not enough space on the USB memory stick, the "NOT ENOUGH SPACE" message will appear.



### NOTE

When you want to return to the previous display, select the "BACK" option then press the "Select" key.

## RESTORE FROM USB

Restores the antenna setting by using the setting files saved in USB.

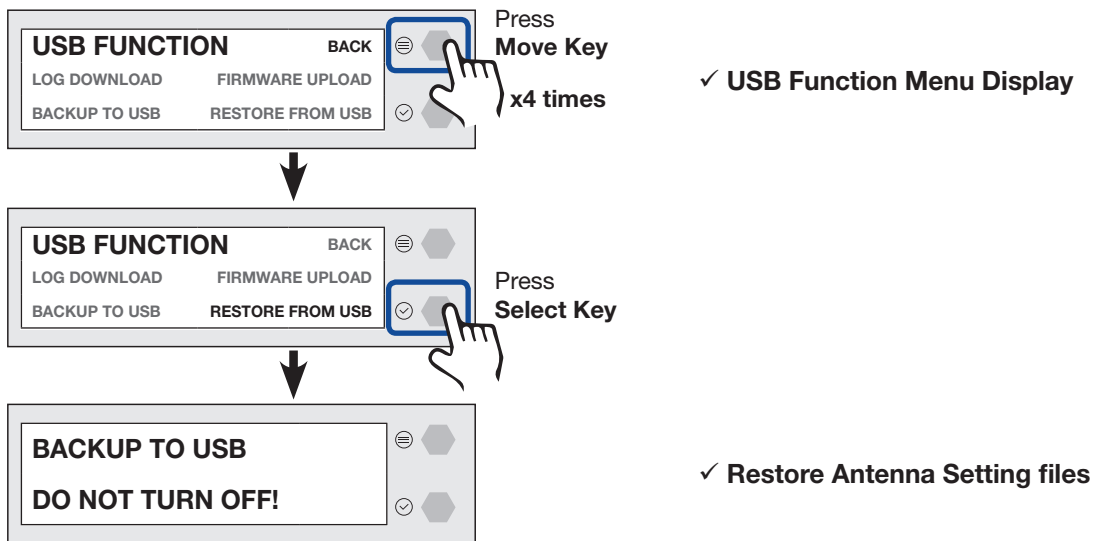

**NOTE**

When you want to return to the previous display, select the "BACK" option then press the "Select" key.

# Using AptusNX

## Introduction

With embedded AptusNX software, the antenna can be monitored, controlled, and diagnosed remotely from anywhere, anytime through TCP/IP protocol. This not only can save time but also save the cost generated from the hundreds of routine maintenance activities such as operating firmware upgrades, tracking parameters resets, and system Diagnosis.

## How to access AptusNX for ACU

1. Connect an Ethernet cable from the Management LAN port on the front of the ACU to the LAN port of PC. This method is most recommended.
2. Enter the ACU's IP address (**192.168.2.1**) into your web browser's address bar to login into the ACU's internal HTML page, if this system has not been changed from the ACU's factory default.

**NOTE****NOTE**

AptusNX can be displayed on Internet Explorer 11 or later (Windows 7 or later), and is also compatible with Firefox, Microsoft Edge and Chrome web browsers.

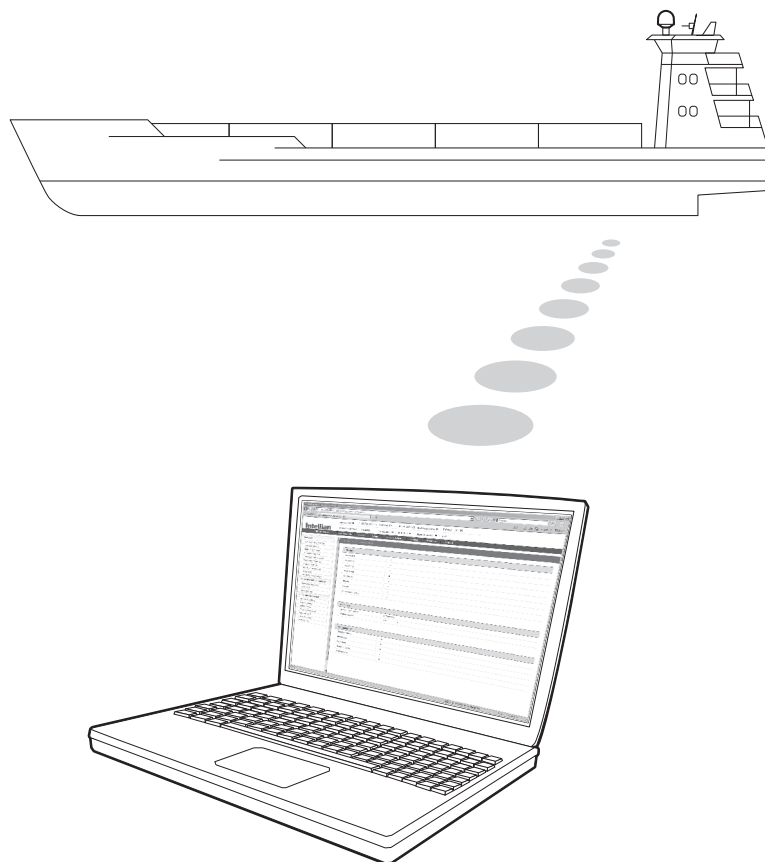



## Main Page

### Page Login

The Intellian software Aptus provides a different user level access to ensure safe operation of the system. Depending on the user level, a limited range or a full range of functions can be accessed and operational.

1. Log into the ACU by typing in User Name and Password information. If this system has not been changed from the factory default:

| User Type | User ID          | Password        | Access Authority   |
|-----------|------------------|-----------------|--|
| Admin     | <i>intellian</i> | <i>12345678</i> | Supports all menus for monitoring and setting.   |
|           | <i>captain</i>   | <i>12345678</i> | Supports all menus for monitoring and setting.<br>Can control and manage user permission separately. |
| User      | <i>guest</i>     | <i>guest</i>    | Only some menus for monitoring are supported.<br>(Dashboard, Tools, Troubleshooting)                 |

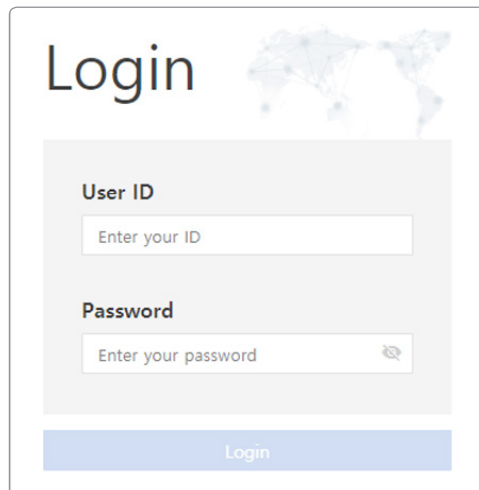

The screenshot shows a login interface with the word "Login" at the top left. To the right is a faint world map. Below the title are two input fields: "User ID" with the placeholder "Enter your ID" and "Password" with the placeholder "Enter your password" and a small eye icon for toggling visibility. At the bottom is a blue "Login" button.



#### NOTE

After entering with the default password, the user must change the default password to a new password for security.

## Top Menu

Once you log in, the following information and menus are displayed.

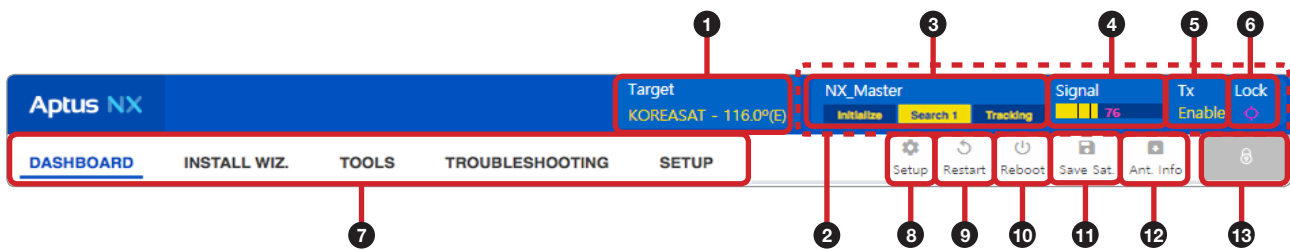

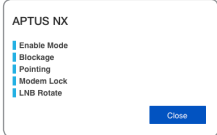
| No.       | Item                     | Description  |           |           |          |       |         |               |                       |   |  |                          |                 |
|-----------|--------------------------|--|-----------|-----------|----------|-------|---------|---------------|-----------------------|---|--|--------------------------|-----------------|
| ①         | Target Satellite         | Displays the name of the targeted satellite.   |           |           |          |       |         |               |                       |   |  |                          |                 |
| ②         | Quick Status Screen Area | When clicking this top menu area (marked as red dots), the "Quick Status Screen" appears. You can quickly monitor each status of the five items (Enable Mode, Blockage, Pointing, Modem Lock, LNB Rotate) through the screen (Blue: enable, Black: disable).<br><br><Quick Status Screen>   |           |           |          |       |         |               |                       |   |  |                          |                 |
| ③         | Antenna Status Info      | Displays the antenna status through a yellow indicator in the SETUP mode. <ul style="list-style-type: none"> <li>Initialize: the antenna system is initialized.</li> <li>Searching: the antenna is searching the target satellite.</li> <li>Tracking: the antenna is tracking the target satellite.</li> </ul>   |           |           |          |       |         |               |                       |   |  |                          |                 |
| ④         | Signal Level             | Displays the current signal level.   |           |           |          |       |         |               |                       |   |  |                          |                 |
| ⑤         | Tx Status                | Displays whether or not the antenna is able to transmit data.  |           |           |          |       |         |               |                       |   |  |                          |                 |
| ⑥         | Lock                     | Displays whether or not the satellite is locked.   |           |           |          |       |         |               |                       |   |  |                          |                 |
| ⑦         | Main Menu                | Selects the Main Menu (DASHBOARD, INSTALL WIZ., TOOLS, TROUBLESHOOTING, SETUP). Each main menu offers side menus on the left of the screen.  |           |           |          |       |         |               |                       |   |  |                          |                 |
| ⑧         | Setup                    | Enters the setup mode to modify settings. The following functions are available only in setup mode. <table border="1" data-bbox="466 1375 1433 1720"> <thead> <tr> <th>Main Menu</th> <th>Side Menu</th> <th>Function</th> </tr> </thead> <tbody> <tr> <td rowspan="3">SETUP</td> <td rowspan="3">Antenna</td> <td>Antenna Angle</td> </tr> <tr> <td>Dish Scan Range Check</td> </tr> <tr> <td>Sensor Calibration               <ul style="list-style-type: none"> <li>Tilt Sensor Bias</li> <li>Rate Sensor Bias</li> </ul> </td> </tr> <tr> <td></td> <td>Backup &amp; Restore Setting</td> <td>Antenna Restore</td> </tr> </tbody> </table> | Main Menu | Side Menu | Function | SETUP | Antenna | Antenna Angle | Dish Scan Range Check | Sensor Calibration <ul style="list-style-type: none"> <li>Tilt Sensor Bias</li> <li>Rate Sensor Bias</li> </ul> |  | Backup & Restore Setting | Antenna Restore |
| Main Menu | Side Menu                | Function   |           |           |          |       |         |               |                       |   |  |                          |                 |
| SETUP     | Antenna                  | Antenna Angle  |           |           |          |       |         |               |                       |   |  |                          |                 |
|           |                          | Dish Scan Range Check  |           |           |          |       |         |               |                       |   |  |                          |                 |
|           |                          | Sensor Calibration <ul style="list-style-type: none"> <li>Tilt Sensor Bias</li> <li>Rate Sensor Bias</li> </ul>  |           |           |          |       |         |               |                       |   |  |                          |                 |
|           | Backup & Restore Setting | Antenna Restore  |           |           |          |       |         |               |                       |   |  |                          |                 |
| ⑨         | Restart                  | Restarts the antenna system.   |           |           |          |       |         |               |                       |   |  |                          |                 |
| ⑩         | Reboot                   | Reboots the antenna system.  |           |           |          |       |         |               |                       |   |  |                          |                 |
| ⑪         | Save Sat.                | Saves bow offset.  |           |           |          |       |         |               |                       |   |  |                          |                 |
| ⑫         | Ant. Info                | Obtains current antenna information.   |           |           |          |       |         |               |                       |   |  |                          |                 |
| ⑬         | Account Button           | Select the "Account" button and enter the user management menu. The "Account" and the "Logout" menu will appear. Select the "Account" menu to manage your account details and select the "Logout" menu to log out of the AptusNX web page.   |           |           |          |       |         |               |                       |   |  |                          |                 |

## Account Menu

1. Select the "Account" button and enter the user management menu.
2. The "Account", "System", "User Mgr.", and "Logout" menu options will appear. Select one of the first three options to manage or control details, or select the "Logout" menu to log out of the AptusNX web page.

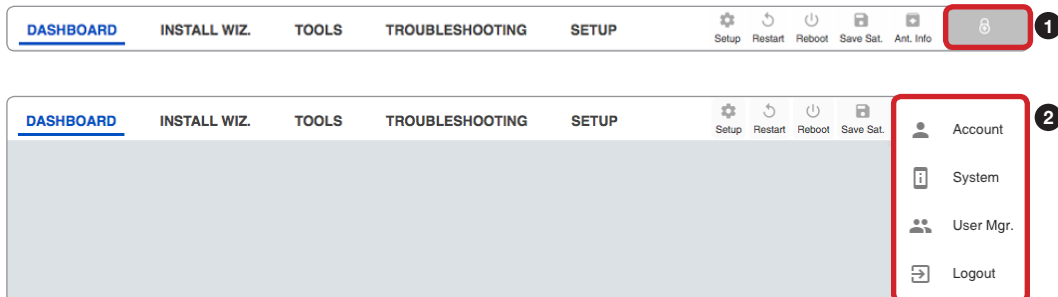

## Account

| No. | Item            | Description   |
|-----|-----------------|---|
| ①   | Account         | Updates your password and sets timeout.   |
| ②   | Change Password | <p>You can change your password.</p> <ul style="list-style-type: none"> <li>• Current User ID: displays your user ID.</li> <li>• User ID: enter the current user ID.</li> <li>• Current Password: enter the current password.</li> <li>• New Password: enter the new password.</li> <li>• Confirm New Password: re-enter the new password to verify that it was entered correctly.</li> </ul> <p>Click the "Change Password" button to change to the new password. At the next login, the new password is required.</p> |
| ③   | Session         | <p>You can set guest connection and timeout.</p> <ul style="list-style-type: none"> <li>• Allow Guest Connections: sets up the guest access option (Disable / Enable).</li> <li>• Idle Session Timeout: sets the Idle timeout.</li> <li>• Console Timeout: sets the console timeout.</li> </ul> <p>Click the "Apply" button to apply the settings to the system.</p>  |

## Registration

Account

**Registration 1**

System

User Mgr.

**2** Product

Antenna V5-85-U1JW

Serial Number V0918070001

**3** Vessel

Has IMO Number  Yes  No

Ship Name Ship\_Name

Type Cargo vessel

Owner Intelliantech

**4** Service Provider

Service Provider 1

Service Provider 2

Service Provider 3

Cancel Register(Update)

| No. | Item             | Description   |
|-----|------------------|---|
| ①   | Registration     | Enters product registration information for the convenient use of a product. Click the "Register (Update)" button to apply the settings to the system.  |
| ②   | Product          | Displays the antenna information. <ul style="list-style-type: none"> <li>Antenna: displays the antenna name.</li> <li>Serial Number: displays the antenna serial number.</li> </ul>   |
| ③   | Vessel           | Enters the vessel information. There are two options whether using the IMO number or not. When you have the IMO number select the "Yes" button and enter the IMO Number. When you do not have the IMO number select the "No" button and enter the Ship Name, Type, and Owner information. <ul style="list-style-type: none"> <li>Has IMO Number: selects whether using the IMO number or not.</li> <li>IMO Number: enters the IMO number.</li> <li>Ship Name: enters the ship name.</li> <li>Type: enters the ship type.</li> <li>Owner: enters the name of the owner.</li> </ul> |
| ④   | Service Provider | Enters the service provider information. <ul style="list-style-type: none"> <li>Service Provider 1/2/3: enters the name of the service provider.</li> </ul>   |

## System

Account
Print

Registration

**System** ①

User Mgr.

**System**

---

**② Antenna Information**

Antenna Size 85 cm / 33.5 inch

Antenna Voltage 47.4V

ACU Voltage 23.4V

Temperature 25.9°C

Antenna Product VS-85-U1JW

ACU Product VP-T84G1

Antenna Serial Number V0918070001

ACU Serial Number V0918070001

System Polarization Co & Cross Pol

System Band Ku Band

---

**③ S/W Version Information**

ACU Main v1.00

Antenna PCU v1.00

Antenna Stabilizer v1.00

Antenna Skew v1.00

Antenna Stacker v1.00

Antenna Destacker v1.00

OLED v1.00

Lib Ver v1.00

---

**④ Network Information**

Control IP 192.168.2.1

Current IP 192.168.2.5

Idle Session Timeout 29:22

Date 2018-08-17

Time 03:25:05

Wifi On

| No. | Item                    | Description   |
|-----|-------------------------|---|
| ①   | System                  | Displays system information such as the antenna, S/W version, and network IP address. |
| ②   | Antenna Information     | Displays antenna information.   |
| ③   | S/W Version Information | Displays S/W version information.   |
| ④   | Network Information     | Displays network information.   |

## User Manager

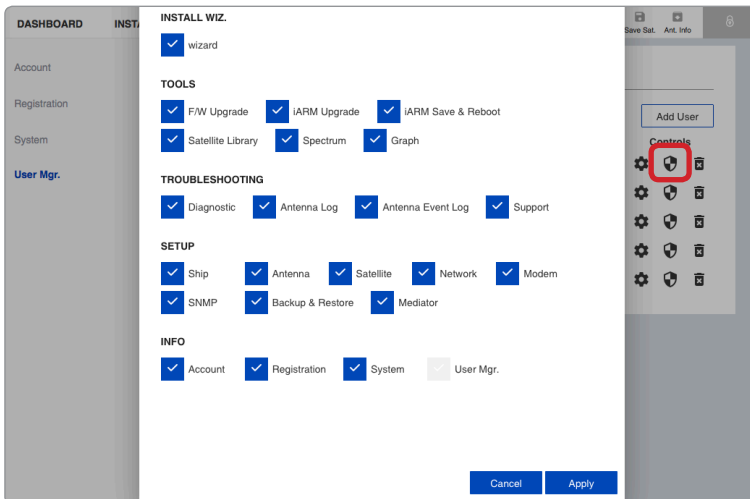
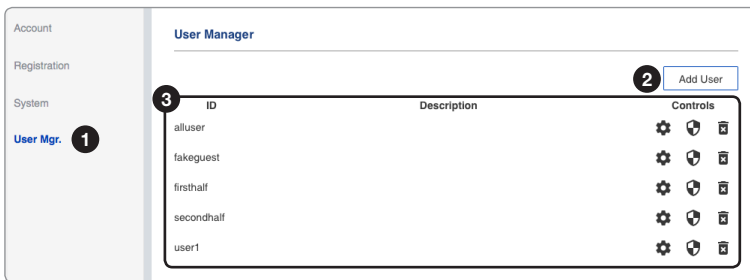

*Editable User Permissions Menu*

| No. | Item                 | Description  |
|-----|----------------------|--|
| ①   | User Manager         | The captain with admin permissions can control and manage user permissions separately.   |
| ②   | Add User             | To add a new user, click the "Add User" button. The registration window will appear in the pop-up window. Enter the new user ID and password then click the "Add User" button.   |
| ③   | User Management List | <p>Displays the user management state and can control and manage through the control buttons.</p> <ul style="list-style-type: none"> <li>• ID: displays the registered user ID.</li> <li>• Description: displays the user's description.</li> <li>• Controls: each user can be controlled and managed by individual settings.                             <ul style="list-style-type: none"> <li>- User Setting: reset the user ID by clicking the "Update User" button, and changes the password by clicking the "Reset Password" button.</li> <li>- Edit Menu Permission: choose user permissions by clicking the checkbox. After selecting the options, click the "Apply" button. The user can only access the selected menus.</li> <li>- Delete User: deletes the user.</li> </ul> </li> </ul> |

# Dashboard

The Dashboard menu is displayed as below to provide quick monitoring of the antenna status. The Dashboard helps you arrange panels on a single screen while providing you with a broad view of a variety of information at once. The dashboard contains multiple panels, which can easily customize the structure of your dashboard and arrange your panels in various ways to make them more readable and user-friendly.

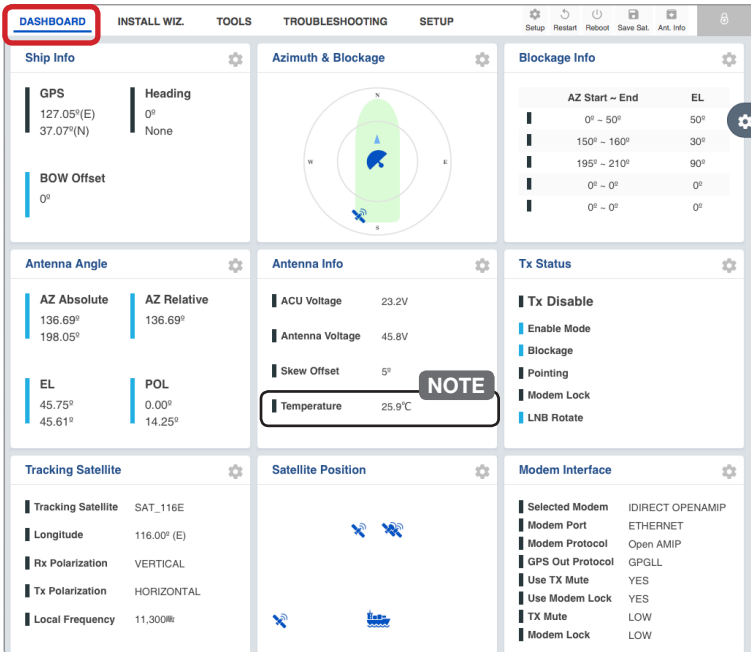

**NOTE**

The measured temperature may differ from the actual temperature.

## How to Add & Remove Panels (Dashboard Setting)

### Adding Panels

1. On the right side of the page, you will see the gear icon to edit your dashboard. To start editing, click on the gear icon.
2. Check the box of the panel that you wish to add to the dashboard.
3. Click the "Apply" button to apply the settings to the system.
4. Once the panel is added, it will be automatically placed at the bottom of the page.

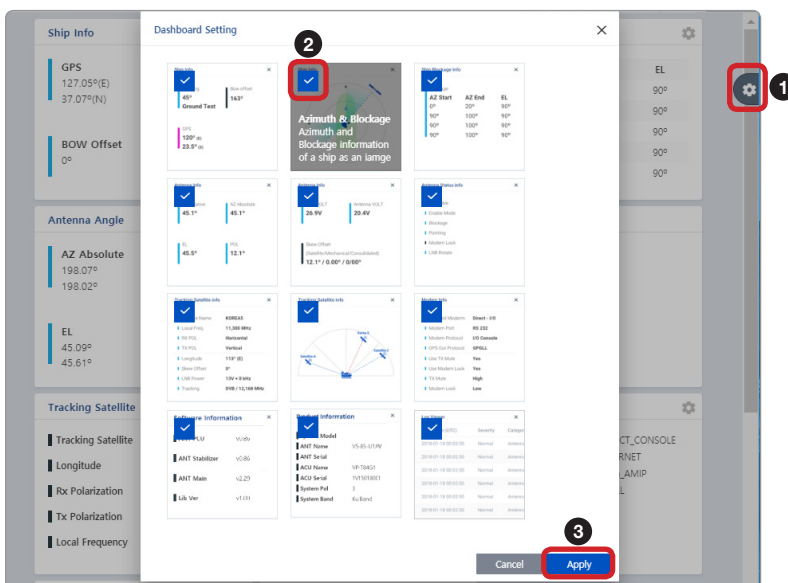

## Removing Panels

1. On the right side of the page, you will see the gear icon to edit your dashboard. To start editing, click on the gear icon indicated by the red mark.
2. Uncheck the box of the panel that you wish to remove from the dashboard.
3. Click the "Apply" button to apply the settings to the system.

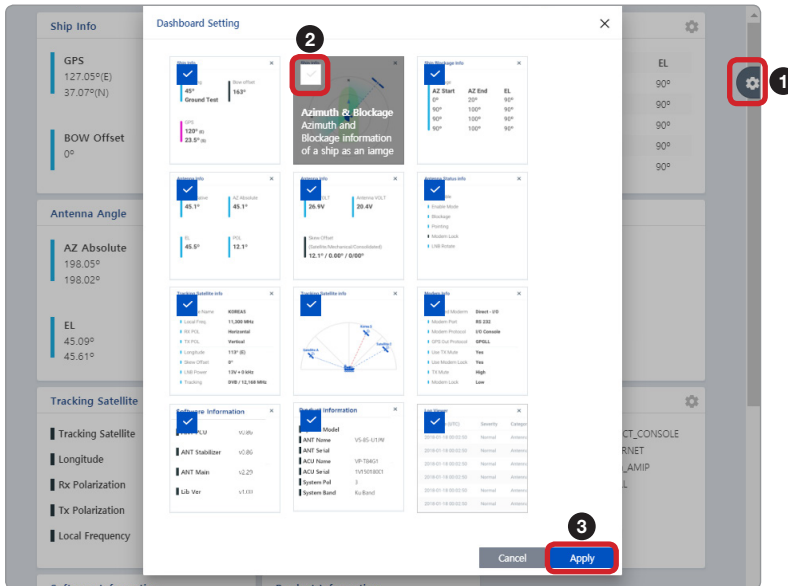

## How to Arrange Dashboard Layout

You can customize the dashboard by rearranging panels as you wish.

1. Click and hold the left mouse button on a panel's title and then drag-and-drop in the desired position.

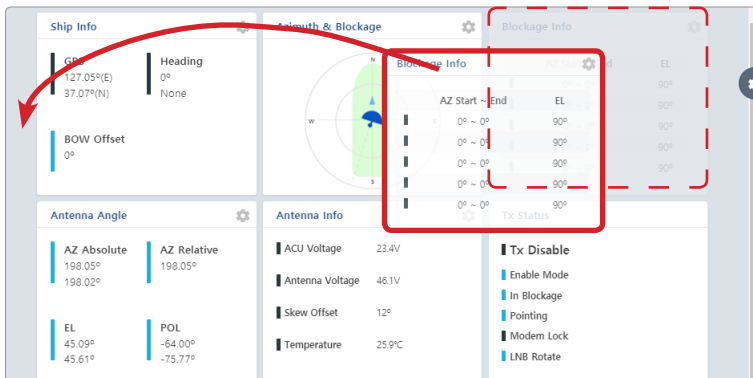

2. This time, the selected panel will be moved to the desired position. You can also move multiple panels into a customized layout in the same manner.

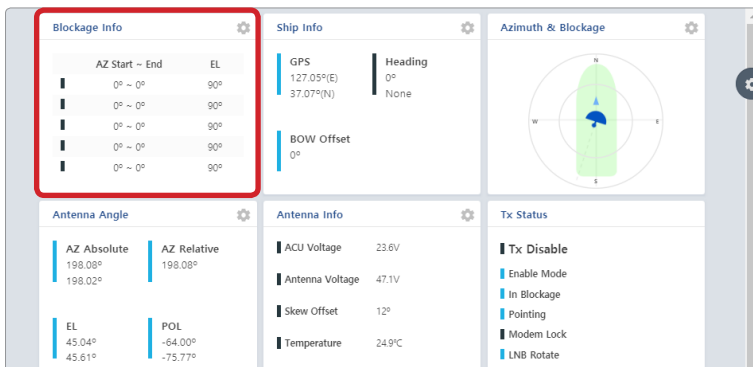



## How to Use Shortcut Settings

Each panel on the dashboard provides a shortcut function. Using the "Shortcut" button on right side of the panel, you can easily access the detailed information and manage the each panel's settings.

1. Click the "Shortcut" button indicated by the red mark to open the setting page.

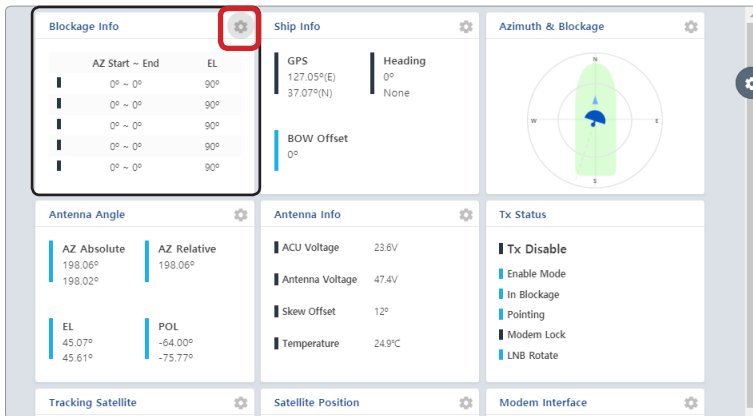

2. The setting page will appear on the individualized web page. You can check the detailed information and quickly apply settings that you wish.

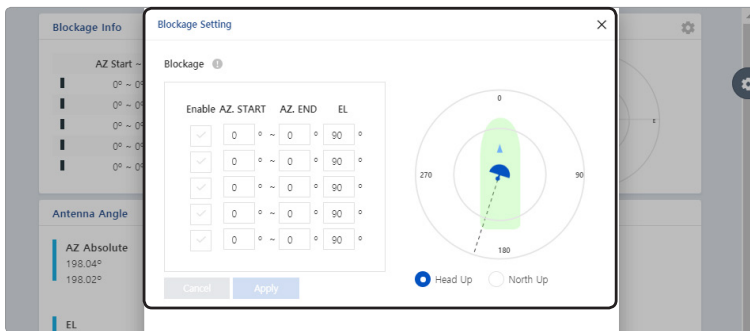

## Install Wizard

The description of this menu is written on the previous page. Refer to the "Operating Install Wizard" on page 48 for more details.

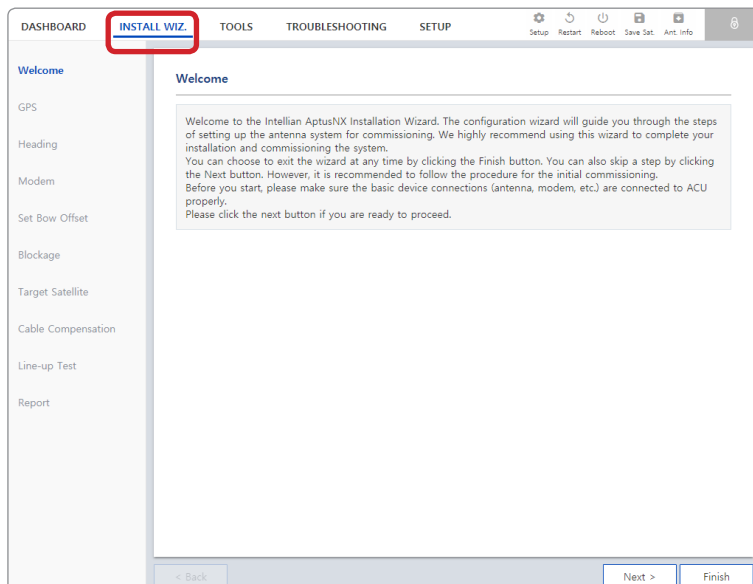

## System Tools

This menu sets and displays the F/W Upgrade, iARM Upgrade, iARM Save&Reboot, Satellite Library, Spectrum Graph and Graph function.

### Firmware Upgrade

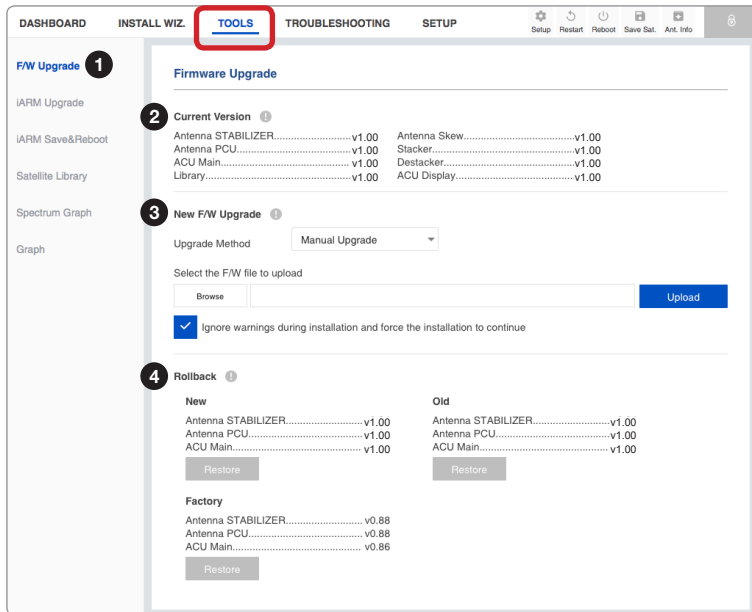

| No. | Item             | Description   |
|-----|------------------|---|
| ①   | Firmware Upgrade | Displays current firmware versions and upgrades antenna firmware.   |
| ②   | Current Version  | Displays current firmware versions (Antenna STABILIZER, Antenna PCU, ACU Main, Library, Antenna Skew, Stacker, Destacker, ACU Display)  |
| ③   | New F/W Upgrade  | Upgrades antenna firmware. The update may take a few minutes to complete. The upload time may vary due to a variety of factors such as the speeds of your network. Uploading an incorrect firmware file may cause serious damage to your antenna and ACU. Please check firmware version before uploading firmware. <ul style="list-style-type: none"> <li>Upgrade Method: selects an upgrade method between "Manual Upgrade" or "Auto Upgrade".</li> </ul> <p><b>NOTE:</b> when using the "Manual Upgrade" method, refer to the following "Antenna Firmware Update (Manual Upgrade method) Procedures" page for more details.</p> |
| ④   | Rollback         | Displays previous/latest firmware package versions and rollback firmware to previous/latest version. Other function cannot be operated while rollback is in progress.   |

### Antenna Firmware Upgrade (Manual Upgrade method) Procedures:

1. Choose "Manual Upgrade" from the pull-down menu of Upgrade Method. Browse and select the upgrade package file to upload. Click on the "Upload" button to transfer the Firmware package file (\*.fwp) to iARM module.

New FW Upgrade

Upgrade Method: Manual Upgrade

Select the FW file to upload

Browse Upload

Ignore warnings during installation and force the installation to continue



NOTE

#### NOTE

When selecting the box "Ignore warnings during installation and force the installation to continue" before performing the upgrade, the warning messages do not appear during the upgrade.

2. The antenna firmware state will appear in the pop-up window. Check the current version and the new version. Click the "Start Upgrade" button.

| Type        | Current Ver. | New Ver. |
|-------------|--------------|----------|
| STAB        | v1.03        | v1.02    |
| PCU         | v1.01        | v1.01    |
| ACU Main    | v1.04        | v1.03    |
| SKEW        | v1.01        | v1.00    |
| STACKER     | v1.02        | v1.00    |
| DESTACKER   | v1.02        | v1.00    |
| ACU Display | v1.00        | v1.00    |

Cancel Start Upgrade

3. During the upgrade process, the window will display process status.

Please do not turn off the power during the upgrade.

| Type        | Current Ver. | New Ver. | Result |
|-------------|--------------|----------|--------|
| STAB        | v1.03        | v1.03    | Skip   |
| PCU         | v1.01        | v1.01    | Skip   |
| ACU Main    | v1.04        | v1.04    | 24 %   |
| SKEW        | v1.01        | v1.01    | Ready  |
| STACKER     | v1.02        | v1.02    | Ready  |
| DESTACKER   | v1.02        | v1.02    | Ready  |
| ACU Display | v1.00        | v1.00    | Ready  |

Ok

4. If the firmware is successfully upgraded, it will display as the "Success". Click the "Ok" button to close the pop-up window.

Please do not turn off the power during the upgrade.

| Type        | Current Ver. | New Ver. | Result  |
|-------------|--------------|----------|---------|
| STAB        | v1.03        | v1.03    | Skip    |
| PCU         | v1.01        | v1.01    | Skip    |
| ACU Main    | v1.04        | v1.04    | Success |
| SKEW        | v1.01        | v1.01    | Skip    |
| STACKER     | v1.02        | v1.02    | Skip    |
| DESTACKER   | v1.02        | v1.02    | Skip    |
| ACU Display | v1.00        | v1.00    | Skip    |

Ok

## iARM Upgrade

The screenshot shows the iARM Upgrade interface with the following components:

- Step 1: iARM Upgrade** - A sidebar menu with 'iARM Upgrade' selected.
- Step 2: New iARM Firmware** - A section titled 'New iARM Firmware' with a sub-header 'Select the F/W file to upload'. It includes a 'Browse' button, a 'Start Upgrade' button, and a checked checkbox for 'Ignore warnings during installation and force the installation to continue.'
- Step 3: Bootstrap/Bootloader** - A section titled 'Bootstrap/Bootloader' showing version information for 'Main' and 'Factory Default' for both 'Bootstrap' and 'Bootloader'.
- Step 4: Kernel/File System** - A section titled 'Kernel/File System' showing version information for 'Kernel' and 'File System' for 'Sys0', 'Sys1', and 'Factory Default'. Each entry has an 'Activate' button. A 'Current Active' section shows the 'Current Package' and its associated 'Kernel' and 'File System' versions.

| No. | Item                 | Description   |
|-----|----------------------|---|
| ①   | iARM Upgrade         | Upgrades the firmware of iARM module.   |
| ②   | New iARM Firmware    | <p>Browse and select the iARM firmware file to upload and click "Start Upload" button. The update may take a few minutes to complete. The upload time may vary due to a variety of factors such as the speeds of your network. Uploading an incorrect firmware file may cause serious damage to your antenna and ACU. Please check firmware version before uploading firmware.</p> <p><b>NOTE:</b> refer to the following "iARM Upgrade Procedures" page for more details.</p>  |
| ③   | Bootstrap/Bootloader | <p>Displays current bootstrap and bootloader version.</p> <ul style="list-style-type: none"> <li>• Bootstrap: displays the Bootstrap Version (Main, Factory Default).</li> <li>• Bootloader: displays the Bootloader Version (Main, Factory Default, Active Bootloader)</li> </ul>  |
| ④   | Kernel/File System   | <p>The ACU has three storage parts the Sys0, the Sys1 and the Factory Default. Selects the desired storage part and click the "Activate" button. Then perform the "iARM Reboot" to apply the settings to the system.</p> <ul style="list-style-type: none"> <li>• Sys0: displays the Sys0 version.</li> <li>• Sys1: displays the Sys1 version.</li> <li>• Factory Default: displays the Factory Default version.</li> </ul> <p>The "Current Active" displays activated storage part Information.</p> <ul style="list-style-type: none"> <li>• Current Active <ul style="list-style-type: none"> <li>- Current Package: displays the activated storage part's name (Sys0, Sys1 or Factory Default).</li> <li>- Kernel, File System: displays the activated storage part's file version.</li> </ul> </li> </ul> |

### iARM Upgrade Procedures:

1. Browse and select the iARM firmware file (.tgz) that you wish to upgrade. Click on "Start Update" button to update the iARM firmware. Wait until the page is loaded.



**NOTE**

When selecting the box "Ignore warnings during installation and force the installation to continue" before performing the upgrade, the warning messages do not appear during the upgrade.

2. Once the update starts, the update process will be displayed on the screen. It will take about two minutes to complete the firmware upgrade.



**WARNING**

Do not turn off the device power if the firmware upgrade page is displayed. Failure to comply may lead to damage and/or malfunction of the system.

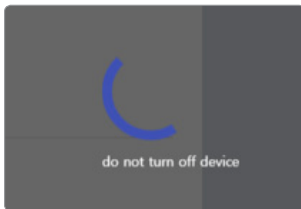

3. Once the upgrade is completed, the iARM module will automatically reboot in 10 seconds.

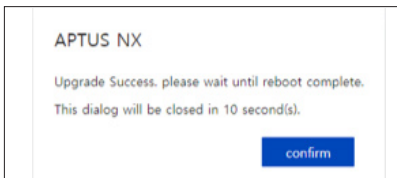

### iARM Save & Reboot

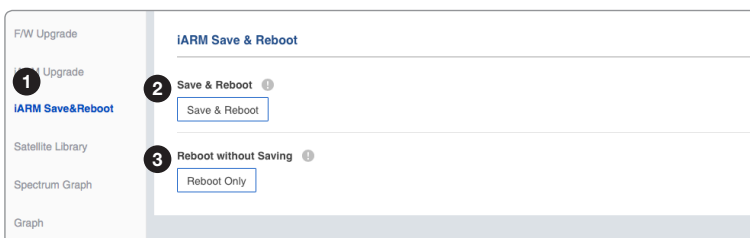

| No. | Item                  | Description  |
|-----|-----------------------|--|
| ①   | iARM Save & Reboot    | Saves settings to the ACU and reboot or reboot the system without saving.  |
| ②   | Save & Reboot         | Saves the modified settings and reboots the iARM. All configuration changes made will be saved in the ACU and effective upon reboot. Click the "Save & Reboot" button. |
| ③   | Reboot without Saving | Reboots the iARM without saving the modified settings. All configuration changes made will be lost upon reboot. Click the "Reboot Only" button.                        |

## Satellite Library

The screenshot shows the 'Satellite Library' configuration window. On the left, a sidebar contains navigation options: F/W Upgrade, IARM Upgrade, IARM Save&Reboot, Satellite Library (highlighted with a red circle 1), Spectrum Graph, and Graph. The main area is titled 'Satellite Library' and contains a 'Satellite List' table (2) with buttons for 'Get Library from ACU', 'Save to PC(Download)', 'Get Library from PC', and 'Save to ACU'. Below the table is a 'Common Information' form (4) with fields for Satellite Name, Longitude, Skew Offset, Identify (radio buttons for Modem Lock and DVB Lock), Rx Polarization, and Tx Polarization. Below that is a 'DVB Information' form (3) with fields for Frequency, Symbol, NID, and Verify Type. At the bottom is an 'NBD Information' form (4) with fields for Frequency, Bandwidth, and Base Local, and a 'Load Satellite' button.

| No. | Item                  | Description   |
|-----|-----------------------|---|
| ①   | Satellite Library     | Sets the satellite library information.   |
| ②   | Satellite List        | Reads or manages satellite information from the library. <ul style="list-style-type: none"> <li>Get Library from ACU: obtains satellite library file from the ACU.</li> <li>Get Library from PC: obtains the satellite library file from the PC.</li> <li>Save to PC (Download): saves the current library file to the PC.</li> <li>Save to ACU: saves the current library file to the ACU.</li> </ul>  |
| ③   | Satellite Information | Select one of the satellites in the "Satellite List" then Click the "Load Satellite" button to load the satellite information.  |
| ④   | Common Information    | Displays selected satellite information. <ul style="list-style-type: none"> <li>Satellite Name: displays the satellite name.</li> <li>Longitude(°): displays satellite orbit position.</li> <li>Skew Offset: displays the Skew offset.</li> <li>Identify: displays the lock setting type (Modem Lock / DVB Lock) for satellite tracking.</li> <li>Rx Polarization: displays the current RX polarization.</li> <li>Tx Polarization: displays the current TX polarization.</li> </ul> |
| ⑤   | DVB Information       | Displays DVB mode's tracking information. <ul style="list-style-type: none"> <li>Frequency (MHz): displays the tracking frequency.</li> <li>Symbol (kSps): displays the symbol rate.</li> <li>NID: displays the network ID.</li> <li>Verify Type: displays the verification type.</li> </ul>  |
| ⑥   | NBD Information       | Displays NBD mode's tracking information. <ul style="list-style-type: none"> <li>Frequency (kHz_IF): sets the tracking frequency.</li> <li>Bandwidth (kHz): sets the detection bandwidth.</li> <li>Base Local (MHz): sets the base local.</li> </ul>  |

## Spectrum Graph

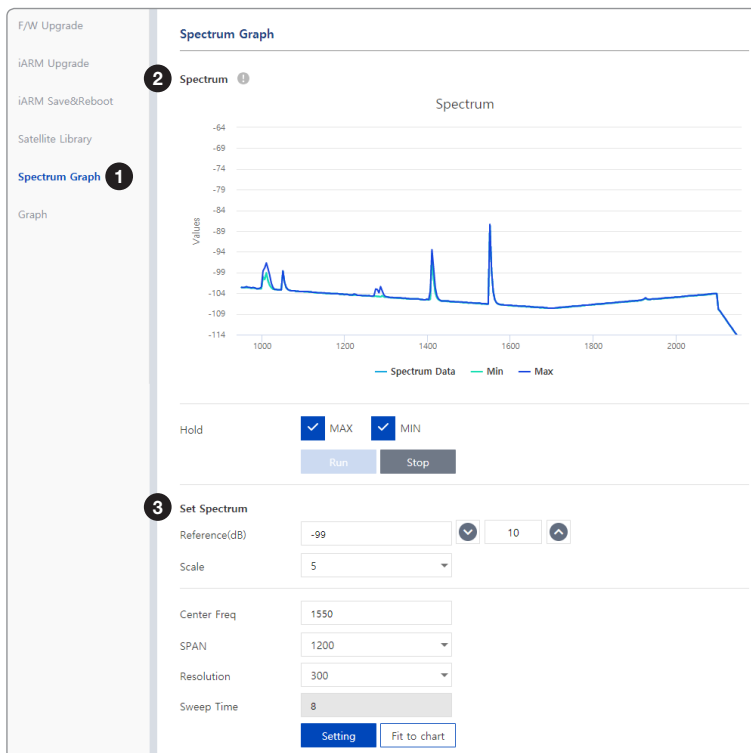

| No. | Item           | Description   |
|-----|----------------|---|
| ①   | Spectrum Graph | Displays a spectrum analyzer, measures an input Rx signal frequency within the full frequency range, and sets spectrum data view options. The disconnect fault can be checked and solved through spectrum analyzer results.   |
| ②   | Spectrum Graph | Displays measurement results. The display of a spectrum analyzer has the frequency on the horizontal axis and the amplitude displayed on the vertical axis. <ul style="list-style-type: none"> <li>• Hold: displays the minimum/maximum value of the frequency band on the graph.</li> <li>- Max: display the maximum value of the frequency band by clicking the check button.</li> <li>- Min: display the minimum value of the frequency band by clicking the check button.</li> <li>• Run: requests the spectrum data to antenna continuously and update graph data in real-time.</li> <li>• Stop: Stops requesting the spectrum data. (The graph cannot be updated.)</li> </ul>   |
| ③   | Set Spectrum   | Sets detailed options for the spectrum graph. <ul style="list-style-type: none"> <li>• Reference/Scale: sets Amplitude Reference Level and Scale. Click the Reference Level submenu key and use the arrow keys, or the keypad to change the reference level (2000 to -2000). Select the Scale number (1, 2, 5, or 10 dB) in the drop-down list to enter the desired scale.</li> <li>• Center Freq.: enters the desired center frequency using the keypad.</li> <li>• Span: to quickly move the span value up or down, select the span number (6, 60, 300, or 1200 MHz) in the drop-down list. These numbers facilitate a zoom-in, zoom-out feature.</li> <li>• Resolution: to quickly adjust the resolution value up or down, select the resolution number (100, 200, 300, or 600) in the drop-down list. These numbers facilitate a zoom-in, zoom-out feature.</li> <li>• Sweep Time: displays the elapsed time all data received during the start to stop testing interval.</li> </ul> <p>Click the "Setting" button to apply the settings to the graph. By clicking the "Fit to chart" button, the reference and scale value are automatically adjusted to easily check the resulting graph.</p> |

# Graph



Single Chart View

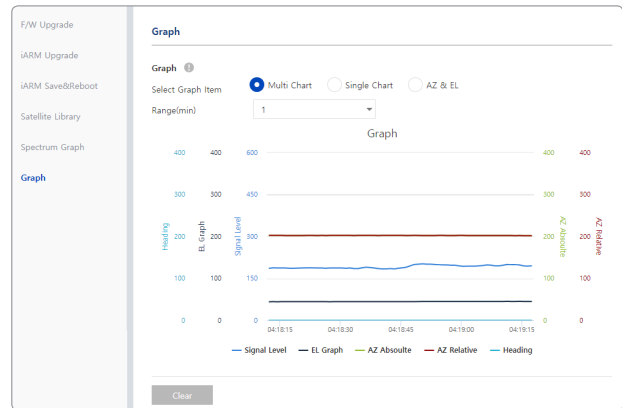

Multi Chart View

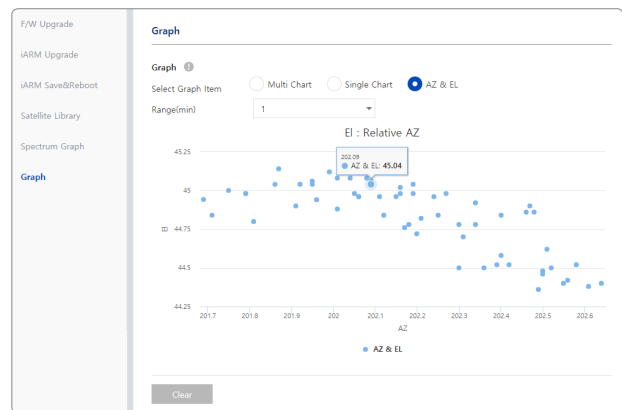

AZ & EL View

| No. | Item  | Description  |
|-----|-------|--|
| ①   | Graph | This view provides information on the Signal Level, EL Graph, AZ Absolute, AZ Relative, Heading in the Multi Chart, Single Chart or AZ & EL formats.   |
| ②   | Graph | <p>Sets detailed options for the graph.</p> <ul style="list-style-type: none"> <li>Select Graph Item: shows the graphs of only the checked item(s) in the Multi Chart, Single Chart or AZ &amp; EL formats.</li> <li>- Multi Chart: displays multiple graph Items in one graph View.</li> <li>- Single Chart: displays the checked graph Item in each graph View.</li> <li>- AZ &amp; EL: displays the AZ / EL angle value in one graph View.</li> <li>• Range(min): displays the data for the set time.</li> </ul> <p>By clicking the "Clear" button, the existing displayed graph is cleared and a new graph is displayed.</p> |



# System Troubleshooting

This menu sets and displays the Diagnosis, Antenna Log, Antenna Event Log and Support function.

## Diagnosis

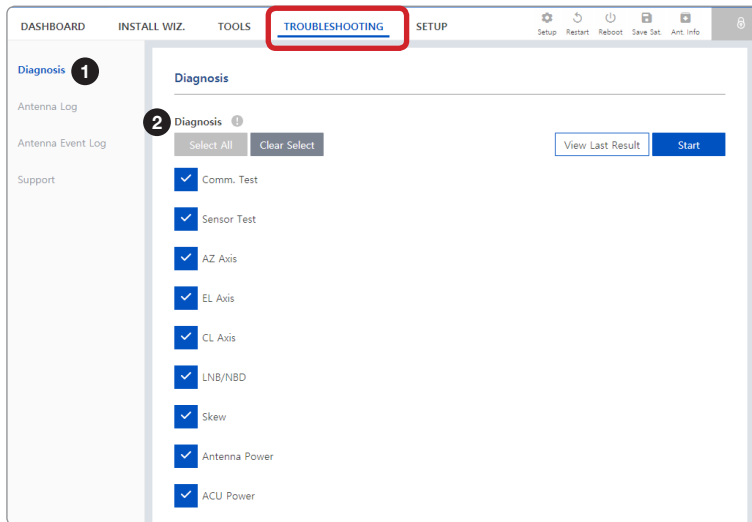

| No. | Item      | Description   |
|-----|-----------|---|
| ①   | Diagnosis | Executes antenna diagnosis test to check the antenna status.  |
| ②   | Diagnosis | <p>Select the checkbox (full diagnosis test or single diagnosis test) before modifying the settings.</p> <ul style="list-style-type: none"> <li>• Select All: select to run a full diagnosis test.</li> <li>• Clear Select: select to run a single diagnosis test.</li> <li>• View Last Result: displays the recently saved diagnosis result.</li> <li>• Start: executes the diagnosis test.</li> </ul> |

### Diagnosis Procedures:

1. Select the checkbox (full diagnosis test or single diagnosis test) before modifying the settings. Click on the "Start" button to run the diagnostic test.

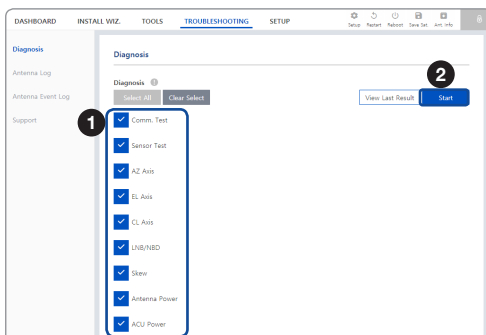

- Once the diagnosis starts, the page will indicate test status. It should take a few minutes to complete the test.

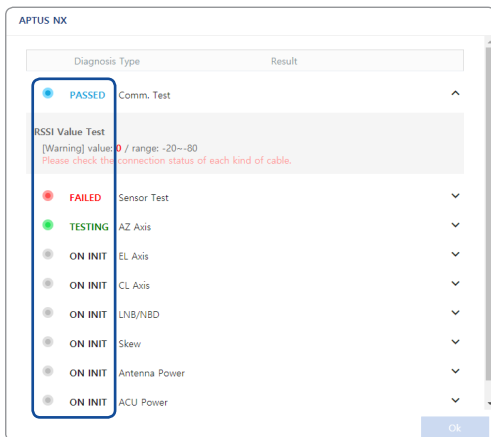

- After the diagnosis is completed the system shows the diagnosis results of each item. You can save the results to the ACU by clicking the "Save Report" button and print this page by clicking the "Print" button.

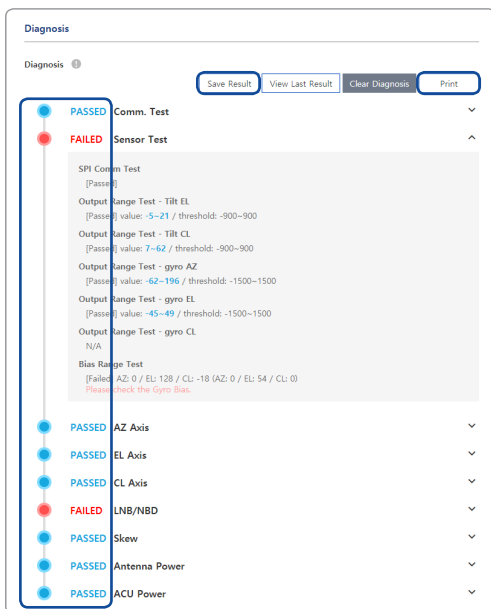

- When you want to check the recently saved diagnosis results, click the "View Last Report" button. The pop-up page of the diagnosis results, including the save date and time, will appear. You can print this page by clicking the "Print" button.

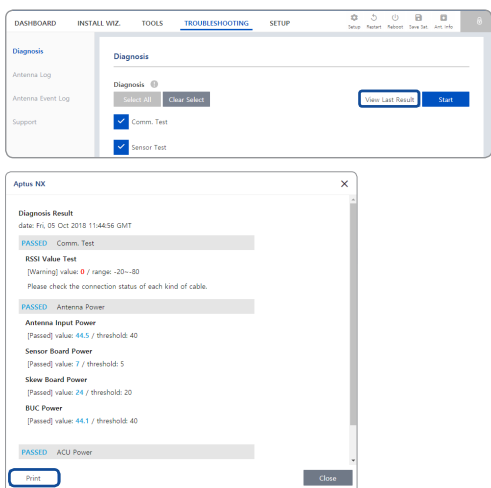

## Antenna Log

Diagnosis

**Antenna Log** ①

Antenna Event Log

Support

**2** GPS Log Option ②

Turn On  Off  On

**3** Antenna Log Download ③

Duration

Include Backup/Report File  Compress

[Start Download](#)

**4** Antenna F/W Log ④

| Date/Time (UTC 00:00)     | STAB            | PCU             | Main            |
|---------------------------|-----------------|-----------------|-----------------|
| Wed, 25 Jul 2018 06:16:13 | 0.94<br>Success | 0.94<br>Success | 0.94<br>Success |

| No. | Item                 | Description   |
|-----|----------------------|---|
| ①   | Antenna Log          | Displays the antenna log data.  |
| ②   | GPS Log Option       | Turns on/off the GPS log download option. Click the "Apply" button to apply the settings to the system.   |
| ③   | Antenna Log Download | Any log data within three months can be downloaded. Select the duration on the calendar view that you want to show. Then click the "Start Download" button.<br><b>NOTE:</b> when selecting the box "Include Backup/Report File" before downloading, the Backup/Report File will download together. When selecting the box "Compress" before downloading, log files are downloaded in a compressed format. |
| ④   | Antenna F/W Log      | Displays log information about firmware upgrade.  |

## Antenna Event Log

| No. | Item              | Description  |
|-----|-------------------|--|
| ①   | Antenna Event Log | Displays the antenna system and user log information by setting urgency level.   |
| ②   | Query Filter      | <p>Sets the log message option to display the event log.</p> <ul style="list-style-type: none"> <li>Severity: sets the urgency level.</li> <li>Category: sets the target that caused the message.</li> <li>Time Frame: sets the time limit that you want to show.</li> <li>Duration: sets the duration on the calendar view that you want to show.</li> <li>Tracking Method: sets the sorting type (Descending / Ascending).</li> </ul> <p>Click the "Query Event Log" button to apply the settings to the system.</p> |
| ③   | Event Log         | Displays event log information.  |

## Support

| No. | Item            | Description   |
|-----|-----------------|---|
| ①   | Support         | Supports the manual web page, support desk and FAQ list.  |
| ②   | Manual and Help | <p>Shows the manual web page and support desk information.</p> <ul style="list-style-type: none"> <li>View Manual: click the "View Manual" button to open the manual web page.</li> <li>Support Desk: click the "Support Desk" button to open Intellian's contact details for support.</li> </ul> |
| ③   | FAQ             | Provides answers to frequently asked questions about the product.   |

# System Setting

This menu sets and displays the Ship, Antenna, Satellite, Network, Modem/BUC, SNMP, Backup & Restore and Mediator function.

## Ship Setting

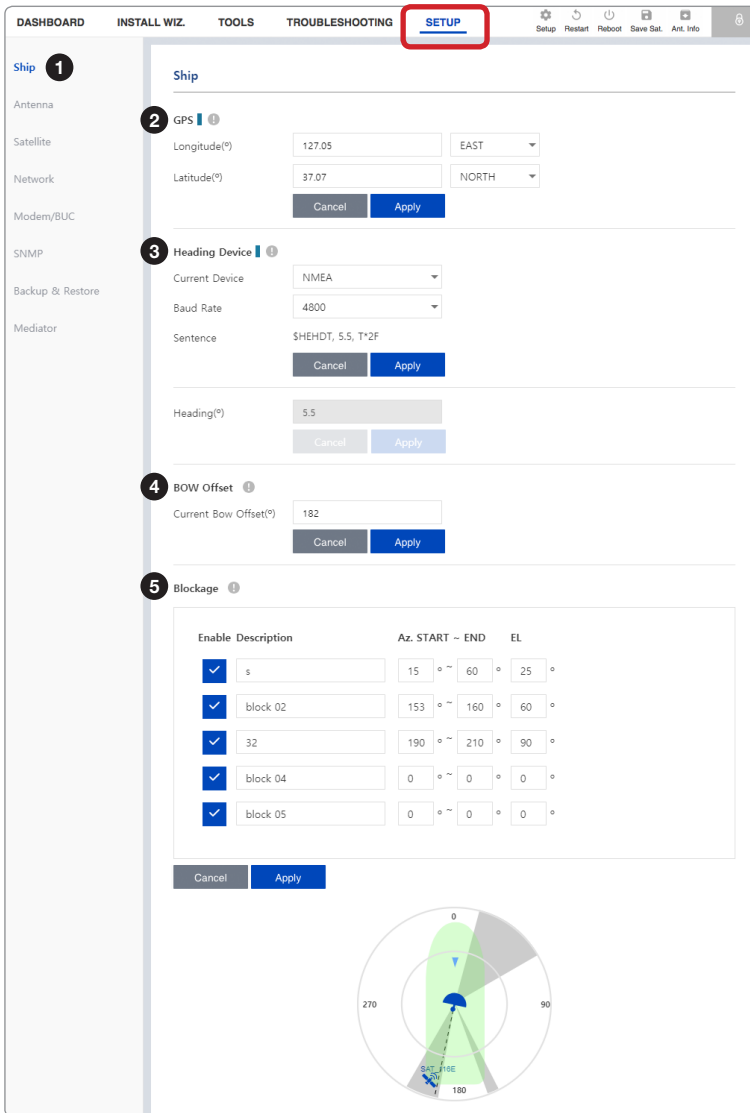

| No. | Item | Description  |
|-----|------|--|
| ①   | Ship | Sets the ship information and block zone.  |
| ②   | GPS  | <p>Sets the GPS position of the vessel for searching for a satellite. Check the GPS status connected to the antenna system. The indicator left of the help button shows the GPS status. Please confirm the GPS indicator is Blue (blinking). (Blue (blinking): the system received a correct GPS input. Black: the system has not received a GPS input. You can enter the GPS value manually to set the GPS position.)</p> <ul style="list-style-type: none"> <li>Longitude(°): sets Longitude information (East / West).</li> <li>Latitude(°): sets Latitude information (North / South).</li> </ul> <p>Click the "Apply" button to apply the settings to the system.</p> |

| No. | Item           | Description   |
|-----|----------------|---|
| ③   | Heading Device | <p>Sets the ship's heading device. Choose the device type from the "Current Device" drop-down list. The indicator left of the help button shows the device connection status. (Blue: a ship's heading device is connected. Black: a ship's heading device is not connected.)</p> <ul style="list-style-type: none"> <li>• Current Device: select the heading device (None / NMEA / NMEA 2000 / Static).</li> <li>• Baud Rate: select the band rate (4800 / 9600 / 19200 / 38400). It must be set when "NMEA" is selected on the "Current Device" list.</li> <li>• Sentence: displays the sentence information. When "NMEA" is selected on the "Current Device" list, this item appears.</li> <li>• Heading(°): enter the heading information.</li> </ul> <p>Click the "Apply" button to apply the settings to the system.</p> |
| ④   | BOW Offset     | <p>For setting bow offset, you need to select a satellite which is trackable in satellite library information. When the antenna tracks the selected satellite, bow offset will be set up automatically.</p> <ul style="list-style-type: none"> <li>• Current Bow Offset(°): enter the Bow Offset Range: 0 – 360°.</li> </ul> <p>Click the "Apply" button to apply the settings to the system.</p>   |
| ⑤   | Blockage       | <p>It is important to set up the blockage zones for Intellian VSAT. The ACU can be programmed with relative azimuth and elevation sectors to create up to five zones where transmit power could endanger personnel who are frequently in that area or blockage exists. Several indications are provided when the antenna is within one of these zones. A transmit inhibit output from the ACU will disable/mute the modem transmission within zones set in this steps The AZ. The START is where the relative azimuth starts and AZ. END is where the relative azimuth ends (Range: 0 - 360°). EL is where the elevation blockage starts (Range 0 - 90°).</p> <p>Click the "Apply" button to apply the settings to the system.</p>  |

# Antenna Setting



**NOTE**

The "Set Rate Sensor Bias" function must be used by experienced engineers only.

| No. | Item            | Description   |
|-----|-----------------|---|
| ①   | Antenna Setting | Sets current antenna position and search parameters.<br>These parameters should only be changed by an authorized service technician. Improper setting of these parameters will render your system inoperable. |

| No. | Item                | Description   |
|-----|---------------------|---|
| ②   | Antenna Angle       | <p>Enter "Setup Mode" to modify settings.</p> <p>Sets current antenna position and LNB pol angle. You can move the antenna's azimuth and elevation position and LNB pol angle by using the arrows or inputting a value to find the desired satellite manually.</p> <ul style="list-style-type: none"> <li>Relative Azimuth: displays the antenna relative azimuth angle.</li> <li>Absolute Azimuth: sets the antenna absolute azimuth angle.</li> <li>Elevation: sets the elevation angle.</li> <li>LNB Pol Angle: sets the LNB pol angle</li> </ul>  |
| ③   | Thresholds Setting  | <p>Sets current detect level threshold and tracking level threshold.</p> <ul style="list-style-type: none"> <li>Detect Level: sets the current detect level threshold.</li> <li>Tracking Level: sets the current tracking level threshold.</li> <li>Tx Enable: sets the TX enable threshold.</li> </ul> <p>Click the "Apply" button to apply the settings to the system.</p>  |
| ④   | Search Parameter    | <p>Sets the time-out, search step and search range.</p> <ul style="list-style-type: none"> <li>Wait Time (sec): sets the time-out for automatic initiation of a search after the signal level drops below the pre-defined threshold value.</li> <li>Search Step(°): sets increment step size.</li> <li>Search1/3: sets Search 1 &amp; 3 search range. Search is conducted in a two-axis pattern consisting of alternate movements in azimuth and elevation to form an expanding square.</li> <li>Search2: this is reserved for future use.</li> </ul> <p>Click the "Apply" button to apply the settings to the system.</p>  |
| ⑤   | Conical Range       | <p>The relative force of the motors controlling azimuth and elevation. Sets the conical range while the antenna is in tracking mode.</p> <p>Click the "Apply" button to apply the settings to the system.</p>   |
| ⑥   | Conical Range Check | <p>Enter "Setup Mode" to modify settings.</p> <p>Monitors the Azimuth and the elevation value when the conical range is modified.</p> <ul style="list-style-type: none"> <li>Switch Activation: choose whether to use the switch activation function or not. (On / Off)</li> </ul> <p>Click the "Apply" button to apply the settings to the system.</p>   |
| ⑦   | Sensor Calibration  | <p>Enter "Setup Mode" to modify settings.</p> <p>Adjusts the elevation to offset the angle difference between the mechanical elevation angle and actual elevation angle.</p> <p>Click the "Apply" button to apply the settings to the system.</p>   |
| ⑧   | Tilt Sensor Bias    | <p><b>NOTE:</b> The tilt values of the elevation and cross-level axes were calibrated to the optimal condition at the factory prior to shipment. However, when the antenna MCU unit or fixed sensor unit is replaced, the elevation and the cross-level axes must be checked by adjusting tilt and rate sensor value. Refer to the replacement manual for detailed procedures. The separate device (e.g. level indicator) for manual adjustment is not provided by Intellian.</p> <p>Enter "Setup Mode" to modify settings.</p> <p>Maintain the elevation and the cross-level axes in order to keep the pedestal parallel to the horizon.</p> <ul style="list-style-type: none"> <li>Ready: click the "Ready" button to bring the elevation and cross-level to 0.</li> <li>EL/CL: select "EL"/"CL" and click the Up and Down arrow keys to adjust the elevation and cross-level.</li> </ul> <p>Click the "Restart" button on the top menu to restarts the antenna system.</p> |



| No. | Item                              | Description  |
|-----|-----------------------------------|--|
| ⑨   | Rate Sensor Bias                  | <p><b>NOTE:</b> The rate values of the azimuth, elevation, and cross-level axes were calibrated to the optimal condition at the factory prior to shipment. If the additional rate adjustment is required, make sure that the antenna is placed on a rigid and flat platform. During the calibration process, the antenna must avoid any motion as it can affect the antenna's performance.</p> <p>Enter "Setup Mode" to modify settings manually.</p> <p>Calibrates DC voltage output from the three rate sensors used to sense antenna motion in azimuth, elevation and cross-level axes. These are used to sense antenna motion that corresponds to the ship's motion (roll, pitch, and yaw) for stabilizing the pedestal. The DC voltage output from each of the rate sensors may vary by an amount which is directly proportional to the direction and rate of motion induced on it.</p> <ul style="list-style-type: none"> <li>• Rate Sensor Calibration: click the "Rate Sensor Calibration" button to calibrate the rate sensor automatically. The indicator left of the help button shows the rate sensor calibration status. (Black: the calibration is ready to start. Blue: the calibration is completed. Red: the calibration is failed. Green: the calibration is in process.)</li> <li>• Save Sensor Bias: click the "Save Sensor Bias" button to save the calibrated value of the rate sensor to the system.</li> </ul> |
| ⑩   | LNB Pol Sensor Calibration (Skew) | <p>Calibrates the LNB pol angle when the control board, the skew motor or belt is replaced.</p> <ul style="list-style-type: none"> <li>• Sat Skew Offset: displays the skew offset value.</li> <li>• Mechanical Offset: displays the skew offset value. The indicator right of the value box shows the skew offset status. (Blue: Mechanical skew offset value is less than <math>\pm 10</math> degrees. Red: Mechanical skew offset value is more than <math>\pm 10</math> degrees.)</li> <li>• Consolidated Offset: displays the consolidated offset value.</li> <li>• Pol Sensor Calibration: calibrates the skew motor and checks the skew range.</li> <li>• Mechanical Skew Offset reset: the mechanical skew offset is present in the factory with a default value (0, 1 or 2) depending on the assembly status. Resetting of the mechanical skew offset may be required when the satellite skew offset is unknown (Consolidated Skew Offset = satellite skew offset + mechanical skew offset). Due to each satellite having its own skew offset, Intellian recommends you check with your service provider or satellite operator to get the satellite skew offset value and input it in "SETUP main menu → Satellite → Satellite Information → Skew Offset" rather than resetting the mechanical skew offset directly.</li> </ul>   |
| ⑪   | Antenna Mode                      | <p>Sets the motor to idle mode to check the antenna's balance.</p> <ul style="list-style-type: none"> <li>• Set Idle Mode: Enter "Setup Mode" to modify settings. Releases the elevation and cross-level motor.</li> <li>• Reboot: reboots the system.</li> </ul>  |

## Tracking Satellite Setting

The screenshot shows the 'Tracking Satellite Setting' configuration page. On the left is a navigation menu with items: Ship, Antenna, Satellite (1), Network, Modem/BUC, SNMP, Backup & Restore, and Mediator. The main content area is titled 'Tracking Satellite Setting' and includes a 'Library' button. It is divided into four sections:

- 2 Satellite Information:** Contains fields for Satellite Name (SAT\_113E), Longitude(°) (113.15), Skew Offset(°) (0), Local Frequency(MHz) (11300), RX Polarization (Vertical), and TX Polarization (Horizontal). It also has radio buttons for Identify: Modem Lock (selected) and DVB Lock.
- 3 NBD Information:** Contains fields for Frequency(kHz\_IF) (1329200) and Reserved Parameter (2000), with Cancel and Apply buttons.
- 4 Eutel Satellite:** Contains a radio button for Eutel Sat: On (selected) and Off, with Cancel and Apply buttons.
- 5 Modem Lock Use for Verification:** Contains a radio button for Modem Verify: On (selected) and Off, with Cancel and Apply buttons.

| No. | Item                            | Description   |
|-----|---------------------------------|---|
| ①   | Tracking Satellite Setting      | Sets the current tracking satellite settings.   |
| ②   | Satellite Information           | <p>Sets the current tracking satellite settings.</p> <ul style="list-style-type: none"> <li>Satellite Name: sets the satellite name.</li> <li>Longitude(°): sets the satellite orbit position.</li> <li>Skew Offset(°): sets the skew offset.</li> <li>Local Frequency (MHz): sets the local frequency.</li> <li>RX Polarization: sets the current RX polarization.</li> <li>TX Polarization: sets the current TX polarization.</li> <li>Identify: sets the lock setting type (Modem Lock / DVB Lock) for satellite tracking.</li> </ul> <p>Click the "Apply" button to apply the settings to the system.</p> |
| ③   | NBD Information                 | <p>Sets NBD mode's tracking information.</p> <ul style="list-style-type: none"> <li>Frequency (kHz_IF): sets the tracking frequency.</li> <li>Reserved Parameter(kHz): sets the reserved parameter.</li> </ul> <p>Click the "Apply" button to apply the settings to the system.</p>   |
| ④   | Eutel Satellite                 | <p>Select "ON" when the antenna is tracking the Eutelsat satellite. With this option enabled, a defined skew angle for each Eutelsat satellite is automatically applied without allowing a manual modification to the skew offset value.</p> <p>Click the "Apply" button to apply the settings to the system.</p>   |
| ⑤   | Modem Lock Use for Verification | <p>Verifies modem lock status (modem lock function: active/inactive).</p> <ul style="list-style-type: none"> <li>Modem Verify: choose whether to use the modem lock function or not. (On / Off)</li> </ul> <p>Click the "Apply" button to apply the settings to the system.</p>   |

## Network Configuration

This function is available after performing the "iARM Save & Reboot" on page 85.

The screenshot shows the 'Network Configuration' page with the following sections:

- 1 Network Configuration:** A sidebar menu with 'Network' highlighted.
- 2 Management Interface Configuration:** Fields for IP Address (192.168.2.1), Subnet Mask (255.255.255.0), Lease Start Address (192.168.2.2), Lease End Address (192.168.2.30), and Lease Time (180).
- 3 WiFi Access Point Configuration:** Radio buttons for AP (Disable/Enable), SSID (intellian-4NX), Channel (6), Authentication Type (Open), Password, Max Stations (10), and SSID Broadcast (Disable/Enable).
- 4 Network Service Configuration:** Radio buttons for Telnet Service (Disable/Enable), HTTPS Port (443), and SSH Service (Disable/Enable). Includes 'Cancel' and 'Apply' buttons.
- 5 Sys Log Configuration:** Radio buttons for Management Server (No/Yes), Server IP (192.168.1.1), UDP Port (514), Message Type (Error, Major, Minor, Diagnosis, Special, Setting, Notice), and Syslog Target Level (LOG NOTICE). Includes 'Cancel' and 'Apply' buttons.
- 6 Radius Configuration:** Radio buttons for Client (Disable/Enable), Server IP (192.168.1.10), Timeout (5), and Server Secret (testing123). Includes 'Cancel' and 'Apply' buttons.

| No. | Item                               | Description   |
|-----|------------------------------------|---|
| ①   | Network Configuration              | Sets the ACU's Internal IP address and ports.   |
| ②   | Management Interface Configuration | <p>Sets the Management Port's network configuration. The Management Port is located on the ACU front panel.</p> <ul style="list-style-type: none"> <li>• IP Address: sets the network IP address (Factory default: 192.168.2.1).</li> <li>• Subnet Mask: sets the subnet mask (Factory default: 255.255.255.0).</li> <li>• Lease Start Address: sets the lease IP address start range.</li> <li>• Lease End Address: sets the lease IP address end range.</li> <li>• Lease Time: sets the lease IP address update time.</li> </ul> <p>Click the "Apply" button to apply the settings to the system.</p> |

| No. | Item                             | Description  |
|-----|----------------------------------|--|
| ③   | Wi-Fi Access Point Configuration | <p>Sets the Wi-Fi access point configuration.</p> <ul style="list-style-type: none"> <li>• AP: sets the AP status (Disable / Enable).</li> <li>• SSID: the SSID is the network name shared among all devices in a wireless network. The SSID must be identical for all devices in the wireless network. It is case-sensitive and must not exceed 32 alphanumeric characters, which may be any keyboard character. Make sure this setting is the same for all devices in your wireless network.</li> <li>• Channel: selects an appropriate channel from the list provided to correspond with your network settings. All devices in your wireless network must use the same channel in order to function correctly. Try to avoid conflicts with other wireless networks by choosing a channel where the upper and lower three channels are not in use.</li> <li>• Authentication Type: the module supports an authentication mode that the 802.11 device uses when it authenticates and associates with an access point or IBSS cell.</li> <li>• Password: sets the Wi-Fi access password.</li> <li>• Max Stations: sets the max stations.</li> <li>• Disable SSID Broadcast: sets the disable SSID broadcast status (Disable / Enable).</li> </ul> <p>Click the "Apply" button to apply the settings to the system.</p> |
| ④   | Network Service Configuration    | <p>Sets the network service configuration</p> <ul style="list-style-type: none"> <li>• Telnet Service: sets the telnet service (Disable / Enable).</li> <li>• HTTPS Port: sets the HTTPS port number.</li> <li>• SSH Service: sets the SSH service status (Disable / Enable).</li> </ul> <p>Click the "Apply" button to apply the settings to the system.</p>  |
| ⑤   | Sys Log Configuration            | <p>Sets the system log configuration. Antenna sends log messages according to the emergency level. Enabling this function sends the message to your management server.</p> <ul style="list-style-type: none"> <li>• Management Server: sets the management server status (No / Yes).</li> <li>• Server IP: sets the management server IP address.</li> <li>• UDP Port: sets the management port.</li> <li>• Message Type: selects message type (Intellian message level) to send to the management server (Lower number indicates higher emergency).</li> <li>• Syslog Target Level: if you select this target level, the management server receives a log message equal to or less than this level.</li> </ul> <p>Click the "Apply" button to apply the settings to the system.</p>   |
| ⑥   | Radius Configuration             | <p>This menu is used when the network administrator needs to authorize user connections using Radius server.</p> <ul style="list-style-type: none"> <li>• Client: sets the Radius authentication (Disable / Enable).</li> <li>• Server IP: sets the Radius server IP Address.</li> <li>• Timeout: sets the Timeout value in seconds for the authentication process.</li> <li>• Server Secret: sets the Pass-Phase. This should be matched between server and ACU.</li> </ul> <p>Click the "Apply" button to apply the settings to the system.</p>  |



NOTE

**NOTE**

When clicking the "Apply" button after editing the system settings, this pop-up message will appear. If you want to automatically save and reboot the system, select the checkbox and click the "Confirm" button.

**APTUS NX**

All configuration changes made will be saved in the ACU and effective upon reboot.



Automatically Save&amp;Reboot upon apply.

Cancel

Confirm

# Modem/BUC Setting

Ship

Antenna

Satellite

Network

**Modem/BUC** 1

SNMP

Backup & Restore

Mediator

### Modem/BUC Setting

**2** Modem

Select Modem: IDIRECT OPENAMIP

Modem Port: ETHERNET

Modem Protocol: Open AMIP

GPS Out Sentence: GLL

Use Tx Mute:  NO  YES

Use Modem Lock:  NO  YES

Cancel Apply

**2** Modem

Select Modem: USER SETTING

Modem Port: RS 232

Modem Protocol: IO Console

GPS Out Sentence: GLL

Use Tx Mute:  NO  YES

Use Modem Lock:  NO  YES

Tx Mute:  LOW  HIGH

Modem Lock:  LOW  HIGH

Cancel Apply

**3** Modem Port Configuration

IP Address (ACU): 10.110.5.194

Subnet Mask: 255.255.255.240

Gateway: 10.110.5.193

DNS: 168.126.63.1

NAT Routing:  Disable  Enable

TCP Modem Protocol Port: 4001

UDP Modem Protocol Port: 49184

Cancel Apply

**4** Modem Connection

Modem IP: 10.110.5.193

Port: 23

ID: admin

Password: .....  Auto Connection

Cancel Connect

Last Update Date: 2018.10.22 5h:36m:46s

Connect: LOGGEDIN

RX SNR: 14.1

**5** Beam Selector

| Beam List | ID | Description   |
|-----------|----|---|
|           | 85 | ktsat-K8-RMVSAT(not in map)   |
|           | 81 | ktsat-K5-RMVSAT-Maritime Beam(not in map)   |
|           | 57 | ktsat-K6-RMVSAT/CMVSAT(not in map)  |
|           | 27 | ktsat-K5-RMVSAT(not in map) <span style="background-color: #ffc107; padding: 2px;">Current</span> |

Apply Lock Reboot Refresh

**6** BUC Status

Refresh

BUC Type: 8W

BUC S/W Version: 4

Tx Status: Off

PLL Lock: Fail

Temperature(C): 28°C

Checksum: Normal

Tx Forward Power: 0.1 W (20.83 dBm)

**7** BUC Setting

Tx Status:  Off  On

Cancel Apply

Compensation Margin (dB): 0

Cancel Apply

**8** Newtec Modem Monitor

dBm: 0

Es/NO: 0

Ntc\_s Request Delay Time (ms): 1000

Cancel Apply

| No. | Item                     | Description   |
|-----|--------------------------|---|
| ①   | Modem/BUC Setting        | Sets the modem and BUC interface.   |
| ②   | Modem                    | <p>Sets the interface between the ACU and the satellite modem.</p> <ul style="list-style-type: none"> <li>• Select Modem: selects your modem type from the "Select Modem" drop-down list for loading a pre-configuration for the type of modem used. The settings related to the modem interface will be set automatically once the modem type is selected. When you select "USER SETTING" the other settings can be changed independently.</li> <li>• Modem Port: selects a proper data communication port for the ACU to interface with the satellite modem.</li> <li>• Modem Protocol: selects a proper communication protocol for the ACU to interface with the modem.</li> <li>• GPS Out Sentence: selects the GPS out sentence type.</li> <li>• Use Tx Mute: selects whether or not to use the "Tx Mute" function from the modem.</li> <li>• Use Modem Lock: selects whether or not to use "Modem Lock" function from the modem.</li> <li>• Tx Mute: <i>this function can be edited when "User Setting" option is selected in the "Select Modem" menu.</i> It selects the TX Mute option. The TX Mute is a transmit inhibit output from the ACU to disable/mute the modem transmit through a 5 V (HIGH) or 0 V (LOW) current whenever the antenna is blocked, searching, or pointed 0.5 degrees off from peak satellite position.</li> <li>• Modem Lock: <i>this function can be edited when "User Setting" option is selected in the "Select Modem" menu.</i> It selects the Modem Lock option. The Modem Lock provides a logic input through a 5V (HIGH) or 0 V (LOW) current to the ACU to identify when the system is on the correct satellite.</li> </ul> <p>Click the "Apply" button to apply the settings to the system.</p> |
| ③   | Modem Port Configuration | <p>This function is available after performing the "iARM Save &amp; Reboot" on page 85.</p> <p>Sets the ACU's internal IP address, routing, and ports.</p> <ul style="list-style-type: none"> <li>• IP Address: sets the network IP address.</li> </ul> <p><b>CAUTION:</b> when using Dual Antenna System, the "IP Address" of the "Modem Port Configuration" for the Primary ACU and the Secondary ACU must be specified differently. If you specified the same IP address, the system will not connect to a modem and can not use a dual antenna system function.</p> <ul style="list-style-type: none"> <li>• Subnet Mask: sets the subnet mask.</li> <li>• Gateway: sets the gateway.</li> <li>• DNS: sets the current default DNS address.</li> <li>• NAT Routing: sets the NAT routing (Enable / Disable).</li> <li>• TCP Modem Protocol Port: sets the TCP port number for modem protocols using TCP as transport.</li> <li>• UDP Modem Protocol Port: sets the UDP port number for modem protocols using UDP as transport.</li> </ul> <p>Click the "Apply" button to apply the settings to the system.</p>  |

| No. | Item                 | Description   |
|-----|----------------------|---|
| ④   | Modem Connection     | <p>Sets the information for connecting with the modem.</p> <ul style="list-style-type: none"> <li>• Modem IP: sets the modem IP address.</li> <li>• Port: sets the connection Port.</li> <li>• ID: sets the connection ID.</li> <li>• Password: sets the connection Password.</li> <li>• Auto Connect: enabling auto connect and rebooting the ACU will save connection data and will auto connect once ACU is powered on next time.</li> <li>• Last Update Date: displays the last update date and time.</li> <li>• Connect: displays last updated data and time of the modem data.</li> <li>• RX SNR: displays the RX SNR data.</li> </ul>  |
| ⑤   | Beam Selector        | <p><i>This menu can be edited when "iDirect Open AMIP Modem" option is selected in the "Select Modem" menu.</i></p> <p>Selects the target satellite that you want to track.</p> <ul style="list-style-type: none"> <li>• Beam List: choose the target satellite in the list.</li> <li>• Apply: click the "Apply" button to apply the selected beam to the system, it will switch to the beam desired.</li> <li>• Lock: within condition given for test or commissioning, if the user wishes to stay on a selected beam, the user can lock the beam by clicking the "Lock" button. This will lead modem stays with the user-selected beam.</li> <li>• Reboot: if you do not want to lock the beam, click the "Reboot" button.</li> <li>• Refresh: click the "Refresh" button to load the latest satellite list.</li> </ul> |
| ⑥   | BUC Status           | <p><i>This function is activated depending on the BUC type.</i></p> <p>Displays current BUC status information (BUC Type, BUC S/W Version, Tx Status, PLL Lock, Temperature, Checksum and Tx Power Level).</p> <ul style="list-style-type: none"> <li>• To Refresh BUC information: click the "To Refresh BUC information" button to update the BUC status information.</li> </ul>  |
| ⑦   | BUC Setting          | <p><i>This function is activated depending on the BUC type.</i></p> <p>Sets the BUC setting options.</p> <ul style="list-style-type: none"> <li>• Tx Status: selects whether or not to use the Tx connection (ON or OFF).</li> <li>• Attenuator (dB): sets attenuation value.</li> </ul> <p>Click the "Apply" button to apply the settings to the system.</p>   |
| ⑧   | Newtec Modem Monitor | <p><i>This menu can be edited when "Newtec AMIP" option is selected in the "Select Modem" menu.</i></p> <p>Sets the Newtec Modem options.</p> <ul style="list-style-type: none"> <li>• dBm: displays the signal level from the Newtec Modem.</li> <li>• Es/NO: displays the Es/NO value from the Newtec Modem.</li> <li>• Ntc_s Request Delay Time (ms): sets the period which the system receives the signal level (dBm) and Es/NO value from the Newtec Modem.</li> </ul> <p>Click the "Apply" button to apply the settings to the system. Then perform the "iARM Save &amp; Reboot" on page 85.</p>  |

## SNMP Setting

| No. | Item                     | Description   |
|-----|--------------------------|---|
| ①   | SNMP Setting             | Sets SNMP configuration.  |
| ②   | SNMP Agent Configuration | <p>Sets the SNMP configuration.</p> <ul style="list-style-type: none"> <li>• SNMP V1/V2 Status: sets SNMP mode.</li> <li>• V1/V2 Community Name: sets SNMP V2 community name.</li> <li>• V3 Authentication Type: sets SNMP V3 authentication mode.</li> <li>• V3 Authentication Encoding: sets SNMP V3 authentication encoding.</li> <li>• V3 Username: sets the V3 username of the SNMP Agent.</li> <li>• V3 Password: sets the V3 password of the SNMP agent. The password must be at least an eight character string.</li> <li>• V3 Private Encoding: sets SNMP V3 private encoding.</li> <li>• V3 Private Password: sets the V3 private password. The password is must be at least an eight character string.</li> <li>• TRAP IP/Port: sets the TRAP IP/Port.</li> <li>• TRAP Parameter: sets the SNMP trap specific parameter.</li> </ul> <p>Click the "Apply" button to apply the settings to the system. Then perform the "iARM Save &amp; Reboot" on page 85.</p> |



## Backup & Restore Setting

The screenshot shows the 'Backup & Restore' configuration page. It is organized into two main sections: 'Antenna Backup & Restore' and 'iARM Backup & Restore'.  
 - In the 'Antenna Backup & Restore' section, the 'Backup to' option is set to 'PC' (radio button selected), and the 'Restore From' option is also set to 'PC'. There are 'Backup' and 'Restore' buttons.  
 - In the 'iARM Backup & Restore' section, the 'Backup to' option is set to 'PC' (radio button selected), and the 'Restore from' option is also set to 'PC'. There are 'Backup' and 'Restore' buttons.  
 - A sidebar on the left contains a list of system components: Ship, Antenna, Satellite, Network, Modem/BUC, SNMP, Backup & Restore (highlighted with a blue bar and numbered 1), and Mediator. The 'Backup & Restore' section is further numbered 2 and 3.

| No. | Item                     | Description   |
|-----|--------------------------|---|
| ①   | Backup & Restore Setting | Backs up & Restores the antenna setting files and the iARM files.   |
| ②   | Antenna Backup & Restore | <ul style="list-style-type: none"> <li>Antenna Backup: Backs up antenna setting files to ACU or PC. Click the "Backup" button to apply the settings to the system.</li> <li>Antenna Restore: Enter "Setup Mode" to modify settings. Restores the antenna setting by using the setting files saved from ACU or PC. Click the "Restore" button to apply the settings to the system.</li> </ul>              |
| ③   | iARM Backup & Restore    | <ul style="list-style-type: none"> <li>iARM Backup: Backs up iARM files to Flash (internal ACU) or PC. Click the "Backup" button to apply the settings to the system.</li> <li>iARM Restore: Restores the iARM files by using the setting files saved from Flash (internal ACU) or PC. Click the "Restore" button to apply the settings to the system then the iARM will automatically reboot.</li> </ul> |

## Mediator Setting (Optional: For Dual Antenna System)

This function is available when using Dual Antenna System.

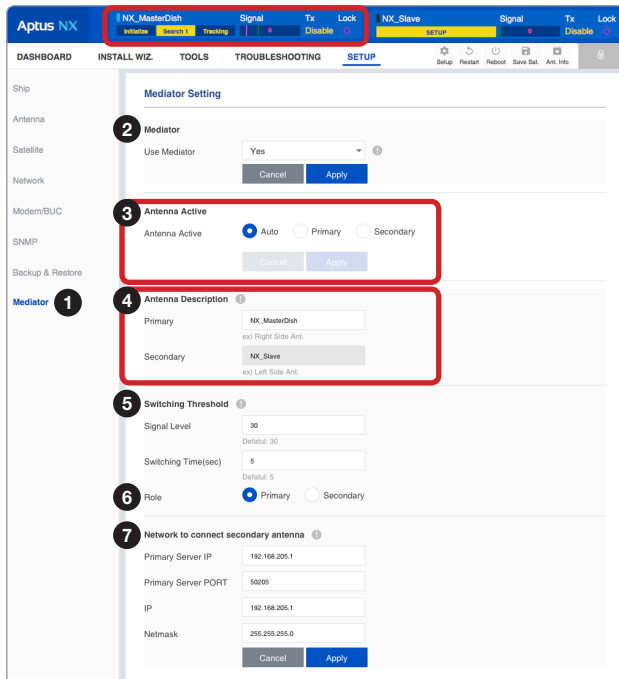

Primary Antenna's AptusNX View

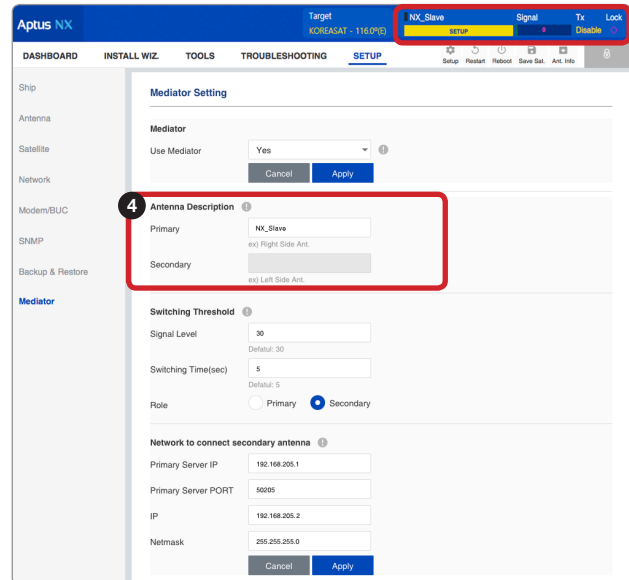

Secondary Antenna's AptusNX View

| No. | Item             | Description   |
|-----|------------------|---|
| ①   | Mediator Setting | Intellian's new ACU has embedded Dual Antenna Mediator function, which can be utilized to switch between two Intellian VSAT antenna systems simultaneously. When one antenna is blocked by obstacles or has suddenly lost service, another antenna will immediately provide fail-safe operation to maintain the highest levels of system performance and reliability.   |
| ②   | Mediator         | Sets whether or not to use the dual antenna mediator function. <ul style="list-style-type: none"> <li>• Yes: enable the mediator function to use the Dual Antenna System. The submenu is shown for detailed function settings.</li> <li>• No: disable the mediator function.</li> </ul> Click the "Apply" button to apply the settings to the system. Then perform the "iARM Save & Reboot" on page 85.   |
| ③   | Antenna Active   | This function is available in the Primary Antenna's AptusNX when both Primary Role's ACU and Secondary Role's ACU are connected to the system. Sets the method for selecting the active antenna. The active antenna (either primary or secondary antenna) is communicating (Tx/Rx) with a satellite. <ul style="list-style-type: none"> <li>• Auto: this method is recommended. Automatically switch-over to the primary or secondary antenna which is no blockages and no errors.</li> <li>• Primary: manually switch-over to the primary antenna which is connected to the modem and the gyrocompass.</li> <li>• Secondary: manually switch-over to the secondary antenna.</li> </ul> Click the "Apply" button to apply the settings to the system. |

| No. | Item                                 | Description  |
|-----|--------------------------------------|--|
| ④   | Antenna Description                  | <p>This menu is differently shown in the Primary Antenna's AptusNX and the Secondary Antenna's AptusNX.</p> <p>To clearly distinguish the primary antenna and the secondary antenna, enter a description to each antenna.</p> <ul style="list-style-type: none"> <li>• Primary: you can enter the description in the primary antenna's AptusNX (Editable). This menu is not shown in the secondary antenna's AptusNX.</li> <li>• Secondary: you can enter the description in secondary antenna's AptusNX (Editable). This menu is only verified in the primary antenna's AptusNX (Read-only).</li> </ul> <p>Click the "Apply" button to apply the settings to the system. Then perform the "iARM Save &amp; Reboot" on page 85.</p>  |
| ⑤   | Switching Threshold                  | <p>When two antennas are in Tracking mode and have no blockage, the allowable value will apply for the automatic switching.</p> <ul style="list-style-type: none"> <li>• Signal Level: if the signal level is less than the set value, the active antenna is automatically switched (Default: 30).</li> <li>• Switching Time (sec): if the signal value difference between the active antenna and inactive antenna is more than the set value which is set in the "Signal Level" menu and the difference is maintained for a set time, the active antenna is automatically switched. Set the switching time value (Default: 5).</li> </ul> <p>Click the "Apply" button to apply the settings to the system. Then perform the "iARM Save &amp; Reboot" on page 85.</p>  |
| ⑥   | Role                                 | <p>Assigns the antenna's role of the primary antenna or secondary antenna.</p> <ul style="list-style-type: none"> <li>• Primary: when running the master ACU, which is connected to the modem and the gyrocompass, select the primary role. The master ACU is assigned and operated as the primary antenna, which will communicate with the target satellite.</li> <li>• Secondary: when running the slave ACU, select the secondary role. The secondary ACU is assigned and operated as the secondary antenna, which will be on standby and ready to assume primary antenna role to provide better service in the event of tracking failure or low signal level status.</li> </ul> <p>Click the "Apply" button to apply the settings to the system. Then perform the "iARM Save &amp; Reboot" on page 85.</p>   |
| ⑦   | Network to connect secondary antenna | <p>Sets the primary antenna's network information to transmit to the secondary antenna.</p> <ul style="list-style-type: none"> <li>• Primary Server IP: enters the server IP address (Default: 192.168.205.1).</li> <li>• Primary Server PORT: sets a server port number for the primary antenna (master) and the secondary antenna, which must be the same number (Default: 50205).</li> <li>• IP: when the antenna role is primary, enter the same IP address with the "Primary Server IP". When the antenna role is secondary, enter a different IP address from the "Primary Server IP"; however, it must be assigned to the same network class as the primary (Default: 192.168.205.1).</li> <li>• Netmask: the primary and secondary netmasks must be the same (Default: 255.255.255.0).</li> </ul> <p>Click the "Apply" button to apply the settings to the system. Then perform the "iARM Save &amp; Reboot" on page 85.</p> |



CAUTION

**CAUTION**

When using Dual Antenna System, the "IP Address" of the "Modem Port Configuration" for the Primary ACU and the Secondary ACU must be specified differently. Refer to the "Modem/BUC Setting" on page 101. If you specified the same IP address, the system will not connect to a modem and can not use a dual antenna system function.

# Specification

## Technical Specification

| <b>Antenna System</b>                                |  |                                       |
|--|--|---------------------------------------|
| Antenna Radome Height                                | 1454 mm (57.44")   |                                       |
| Antenna Radome Diameter                              | Ø1379 mm (54.29")  |                                       |
| Antenna Reflector Diameter                           | Ø1050 mm (41.33")  |                                       |
| Antenna Unit Weight (With Radome)                    | 113 kg (249.12 lbs)  |                                       |
| Platform   | 3-axis: Azimuth, Elevation, Cross-level  |                                       |
| Positioning  | 3-axis Velocity Mode Servo Control:<br>Azimuth, Elevation, Cross-Level   |                                       |
| Azimuth Range  | Unlimited  |                                       |
| Elevation Range                                      | -20° to +115°  |                                       |
| Cross-level Range                                    | Up to ±37°   |                                       |
| Stabilization Accuracy                               | 0.2° peak mispointing @ max ship motion condition  |                                       |
| Motor Brake System                                   | Dynamic braking  |                                       |
| Ship's motion  | Roll   | ±25° at 6 second                      |
|  | Pitch  | ±15° at 6 second                      |
|  | Yaw  | ±8° at 6 second                       |
|  | Turning rate   | Up to 12°/sec & 5°/sec <sup>2</sup>   |
| RX   | Frequency  | 10.7 GHz ~ 12.75 GHz Ku-band          |
|  | Gain   | 40.7 dBi @ 11.7 GHz (without radome)  |
| Tx   | Frequency  | 13.75 GHz ~ 14.5 GHz Ku-band          |
|  | Gain   | 42.0 dBi @ 14.25 GHz (without radome) |
| Above Deck IFL Termination                           | 1 x 50 Ω N-type female connector<br>TX, RX: 10 MHz/50 MHz, 400 MHz, 433 MHz<br>L-band (950 MHz ~ 2150 MHz)<br>DC power to BUC & pedestal (and LNB) |                                       |
| G/T over Rx Range<br>at elevation angle Min. 30 deg. | Min. 20.0 dB/K @ 12.75 GHz (without radome)  |                                       |
| Polarization   | Linear (X-pol, Co-pol)   |                                       |
| BUC  | NJRC 8 W (standard), 16 W, 25 W (optional)   |                                       |
| LNB  | Intellian PLL LNB  |                                       |
| ACU to ADU Cable (Antenna Cable)                     | Single 50 Ω coax cable for Rx, Tx, FSK, Reference and Power from ACU to ADU  |                                       |
| Input power  | 48 V DC (max 500 W) through Rx, Tx RF Cable  |                                       |
| <b>Antenna Control Unit (ACU)</b>                    |  |                                       |
| ACU Size   | 431 mm x 350 mm x 44.3 mm  |                                       |
| ACU Weight   | 5.2 Kg   |                                       |
| Display  | 256 x 64 Graphic OLED  |                                       |
| Key  | Two Push Keys  |                                       |
| LED Indicator  | Three LEDs for Power, Tracking and Error   |                                       |
| USB Port   | 2 ea (front panel), 1 ea (rear panel, for Wi-Fi dongle)  |                                       |
| Ship's Gyrocompass Interface                         | NMEA 2000, NMEA 0183 (GYRO)  |                                       |

|                    |  |
|--------------------|--|
| GPS                | NMEA Out   |
| Serial Interface   | RS-232C (57600 bps 8, N, 1)                            |
| Mediator Interface | Embedded in ACU, Primary, Secondary control on AptusNX |
| Modem Interface    | Ethernet port, RS-232C, RS-422C, I/O Console           |
| Input Power        | 100 ~ 240 V AC, 50 ~ 60 Hz, 3 A                        |

## Environmental Specification

| Test              | Intellian Standard  |  |
|-------------------|---|--|
| Temperature (ADE) | Operational   | IEC-60945 (-25 °C to +55 °C, Power On)                                 |
|                   | Survival  | IEC-60945<br>(-40 °C to +80 °C, Powered On and a non-functional state) |
|                   | Storage   | IEC-60945 (-40 °C to +85 °C, Power off)                                |
| Temperature (ACU) | Operational   | -15 °C to +55 °C (IEC-60945)   |
|                   | Survival  | -25 °C to +70 °C (IEC-60945)   |
|                   | Storage   | -40 °C to +85 °C (IEC-60945)   |
| Wind              | 56 m/sec (125 mph)  |  |
| Humidity          | IEC-60068-2-30<br>Upper test Temp.: +40 °C (-3), Humidity 98 %<br>Lower test Temp.: +15 °C (+3), Humidity 71 % ~ 78 % |  |
| Vibration         | Operational   | IEC-60945  |
|                   | Survival  | IEC-60721-3-6 Class 6M3<br>DNV Standard No. 2.4, Class C               |
| Shock             | Operational   | IEC-60068-2-27 Method Ea 20 g, 7 ms                                    |
|                   | Survival (Transient)  | IEC-60721-3-6 Class 6M3 type II 30 g, 6 ms                             |
|                   | Survival (Bump)   | IEC-60068-2-29 Method Eb 25 g, 6 ms                                    |
| Salt mist         | Saline solution: 5 ±1 % NaCl<br>Storage period: 7 Days (IEC-60945)  |  |
| Waterproofing     | IPX6 (IEC-60529)  |  |
| Solar             | IEC 60945-Annex B.<br>Operational +32 °C air temperature with the addition of 670 Watt/m <sup>2</sup> solar radiation |  |

# Warranty

## Warranty Policy

This product is warranted by Intellian Technologies Inc., to be free from defects in materials and workmanship for a period of THREE (3) YEARS on parts and TWO (2) YEARS on labor performed at Intellian Technologies, Inc. service center from the purchased date of the product.

Intellian Technologies, Inc. warranty does not apply to product that has been damaged and subjected to accident, abuse, misuse, non-authorized modification, incorrect and/or non-authorized service, or to a product on which the serial number has been altered, mutilated or removed.

It is required to present a copy of the purchase receipt issued by Intellian Technologies, Inc. that indicates the date of purchase for after-sales service under the warranty period. In case of failure to present the purchase receipt, the warranty period will begin 30 days after the manufacturing production date of the product purchased.

Any product which is proven to be defective in materials or workmanship, Intellian Technologies, Inc. will (at its sole option) repair or replace during the warranty period in accordance with this warranty. All products returned to Intellian Technologies, Inc. under the warranty period must be accompanied by a return material authorization (RMA) number issued by the dealer/distributor from Intellian Technologies, Inc. and a copy of the purchase receipt as a proof of purchased date, prior to shipment. Alternatively, you may bring the product to an authorized Intellian Technologies, Inc. dealer/distributor for repair.

# Appendix A

## Starting Dual Antenna System (Optional)

Intellian's new ACU has embedded Dual Antenna Mediator function, which can be utilized to switch between two Intellian VSAT antenna systems simultaneously. When one antenna is blocked by obstacles or has suddenly lost service, another antenna will immediately provide a fail-safe operation to maintain the highest levels of system performance and reliability. It ensures always-on broadband service by reducing the out of service time.

### 1. Basic Configuration

To use the Dual Antenna System, make sure that the antenna system components are properly installed. Refer to the "Dual Antenna System Configuration (Optional)" on page 37 for more details.

### 2. Establishing Dual Antenna System Communication

To establish dual antenna system communication between, the primary antenna and secondary antenna must be assigned the antenna role as primary/secondary. Please follow the steps below.

#### 2.1 Connecting Ethernet Cable

Connect an Ethernet cable from the Management LAN port on the front of the master/slave ACU to the LAN port of PC. The network connection is established.

#### 2.2 Dual Antenna System Diagram

The following diagram shows a process for the dual antenna system.

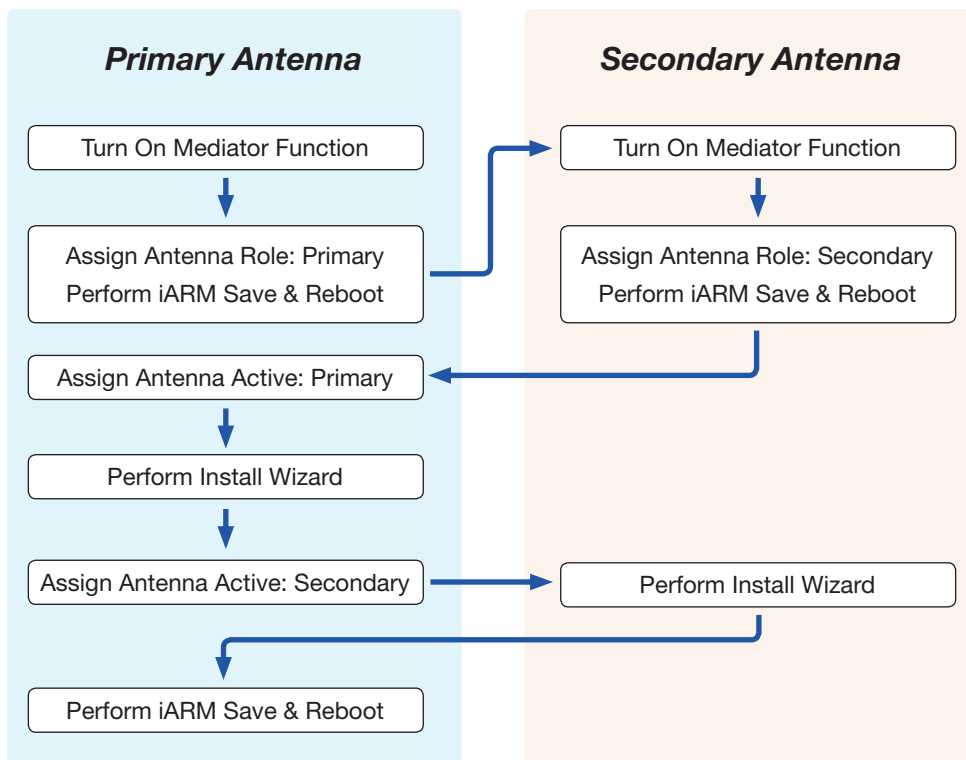

## 2.3 Assigning Antenna Role

Access the AptusNX (IP Address: 192.168.2.1) to manage and control the Dual Antenna System. Go to SETUP menu > Mediator menu > Mediator setting. Select the "Yes" in the Use Mediator menu.

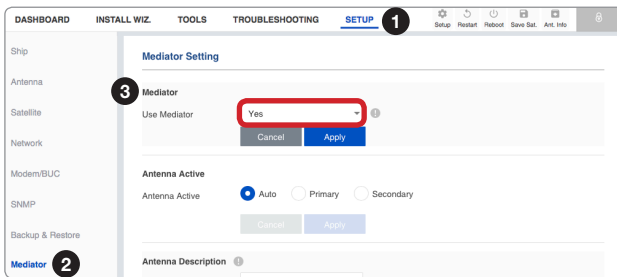

### 2.3.1 Assigning Primary Antenna Role

when connecting the master ACU, which is connected to the modem and the gyrocompass, select the "Primary" role. The master ACU is assigned and operated as the primary antenna, which will communicate with the target satellite. Click the "Apply" button to apply the settings to the system. Then perform the "iARM Save & Reboot" on page 85.

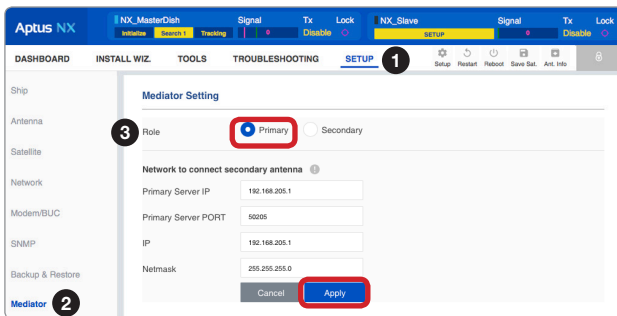

### 2.3.2 Assigning Secondary Antenna Role

when connecting the slave ACU, select the "Secondary" role. The secondary ACU is assigned and operated as the secondary antenna, which will be on standby and ready to assume primary antenna role to provide better service in the event of tracking failure or low signal level status. Click the "Apply" button to apply the settings to the system. Then perform the "iARM Save & Reboot" on page 85.

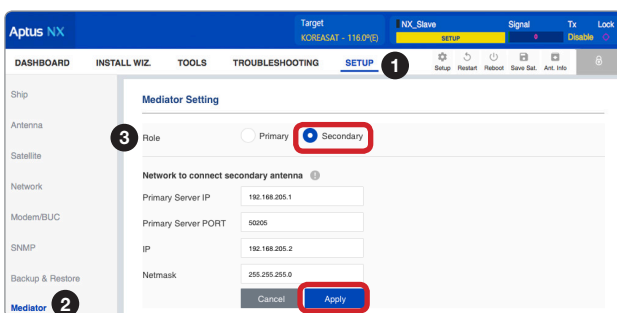

## 3. Performing Install Wizard

*To control and manage both primary and secondary antenna system, access to the Primary Antenna's AptusNX. Before starting the dual antenna system, perform the Install Wizard of the primary and secondary antenna system.*

### 3.1 Performing Install Wizard for Primary Antenna System

To perform the Install Wizard of the primary antenna system, follow the steps below.

#### 3.1.1 Assigning Active Antenna

Select the "Primary" in the Antenna Active menu. Click the "Apply" button to apply the settings to the system.



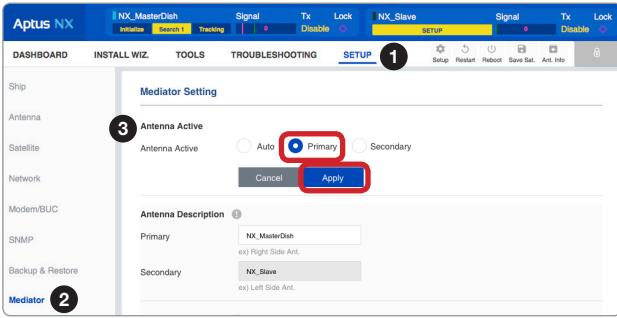

### 3.1.2 Performing Install Wizard

Perform the Install Wizard process. Refer to the "Starting Install Wizard" on page 48 for more details.

### 3.2 Performing Install Wizard for Secondary Antenna System

To perform the Install Wizard of the secondary antenna system, follow the steps below.

#### 3.2.1 Assigning Active Antenna

Select the "Secondary" in the Antenna Active menu. Click the "Apply" button to apply the settings to the system.

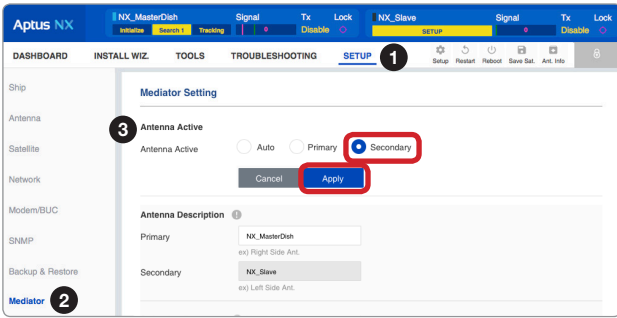

#### 3.2.2 Performing Install Wizard

Perform the Install Wizard process. Refer to the "Starting Install Wizard" on page 48 for more details. Then perform the "iARM Save & Reboot" on page 85.

## 4. Monitoring Dual Antenna System Status

You can monitor the status of Dual Antenna System via AptusNX. The information for two antennas (Primary and Secondary Antenna) is displayed on the Top Menu and the three panels (Dual Antenna Status, Primary Antenna and Secondary Antenna) is displayed on the dashboard screen.

