

FURUNO

OPERATOR'S MANUAL

*VOYAGE DATA RECORDER (VDR)
SIMPLIFIED VOYAGE DATA
RECORDER (S-VDR)*

Model **VR-7000/VR-7000S**

FURUNO ELECTRIC CO., LTD.

9-52 Ashihara-cho,
Nishinomiya, 662-8580, JAPAN

• FURUNO Authorized Distributor/Dealer

All rights reserved. Printed in Japan

Pub. No. OME-44850-R1

(REFU) VR-7000/7000S

A : JUL. 2014

R1 : JAN. 10, 2023



0 0 0 1 9 7 2 0 4 1 5

IMPORTANT NOTICES

General

- This manual has been authored with simplified grammar, to meet the needs of international users.
- The operator of this equipment must read and follow the instructions in this manual. Wrong operation or maintenance can void the warranty or cause injury.
- Do not copy any part of this manual without written permission from FURUNO.
- If this manual is lost or worn, contact your dealer about replacement.
- The contents of this manual and the equipment specifications can change without notice.
- The example screens (or illustrations) shown in this manual can be different from the screens you see on your display. The screens you see depend on your system configuration and equipment settings.
- Save this manual for future reference.
- Any modification of the equipment (including software) by persons not authorized by FURUNO will void the warranty.
- The following concern acts as our importer in Europe, as defined in DECISION No 768/2008/EC.
 - Name: FURUNO EUROPE B.V.
 - Address: Siriusstraat 86, 5015 BT, Tilburg, The Netherlands
- The following concern acts as our importer in UK, as defined in SI 2016/1025 as amended SI 2019/470.
 - Name: FURUNO (UK) LTD.
 - Address: West Building Penner Road Havant Hampshire PO9 1QY, U.K.
- All brand, product names, trademarks, registered trademarks, and service marks belong to their respective holders.

How to discard this product

Discard this product according to local regulations for the disposal of industrial waste. For disposal in the USA, see the homepage of the Electronics Industries Alliance (<http://www.eiae.org/>) for the correct method of disposal.

How to discard a used battery

Some FURUNO products have a battery(ies). To see if your product has a battery, see the chapter on Maintenance. If a battery is used, tape the + and - terminals of the battery before disposal to prevent fire, heat generation caused by short circuit.

In the European Union

The crossed-out trash can symbol indicates that all types of batteries must not be discarded in standard trash, or at a trash site. Take the used batteries to a battery collection site according to your national legislation and the Batteries Directive 2006/66/EU.

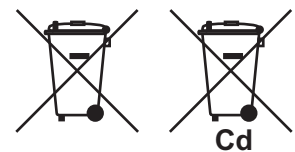

In the USA

The Mobius loop symbol (three chasing arrows) indicates that Ni-Cd and lead-acid rechargeable batteries must be recycled. Take the used batteries to a battery collection site according to local laws.

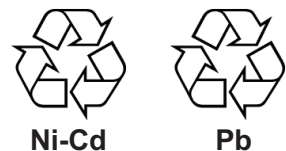

In the other countries

There are no international standards for the battery recycle symbol. The number of symbols can increase when the other countries make their own recycle symbols in the future.



SAFETY INSTRUCTIONS



WARNING

Indicates a condition that can cause death or serious injury if not avoided.



CAUTION

Indicates a condition that can cause minor or moderate injury if not avoided.



Warning, Caution



Prohibitive Action



Mandatory Action



WARNING



ELECTRICAL SHOCK HAZARD
Do not open the equipment.

Only qualified personnel should work inside the equipment.



Do not disassemble or modify the equipment.

Fire, electrical shock or serious injury can result.



Immediately turn off the power (BATTERY and AC switches in that order) at the DCU and also turn off the power at the ship's mains switchboard if water leaks into the equipment or the equipment is emitting smoke or fire.

Continued use can cause fatal damage to the equipment.



Do not disassemble the DRU.

The important data is saved to the DRU. To prevent the loss of data, do not disassemble the DRU.



Do not allow rain or water splash to contact the equipment.

Fire or electrical shock can result.



WARNING



Do not disassemble the battery in the DCU.

Battery fluid is harmful to the eyes and skin, particularly the eyes. If the fluid contacts skin or eyes, flush area with fresh water and contact a physician immediately.



Do not short battery terminals.

Short can lead to bursting or fire.



Do not dispose of the battery or acoustic beacon of the Fixed DRU in fire.

Those components may burst if disposed of in fire. Further, dispose of the battery in accordance with appropriate regulations.



Do not touch any electrically conductive parts.

Touching electrically conductive parts can result in electrical shock. Use rubber gloves, etc. when conducting inspection or maintenance work.



Use the correct fuse.

A wrong fuse can cause fire or serious damage to the equipment.

 **WARNING**

 **Do not wet the capsule of the Float-free DRU.**

The wetted capsule may accidentally transmit a signal.

 **Do not approach the antenna of the Float-free DRU.**

The antenna of the Float-free DRU emits electromagnetic radio frequency (RF) that can be harmful to the human body. Distance at which RF radiation level of 100 and 10 W/m² are given in the table below.

| RF power density | Distance | Description required by |
|---------------------|----------|-------------------------|
| 100W/m ² | 0.16m | IEC60945 |
| 10W/m ² | 0.48m | IEC60945 |

 **CAUTION**

 **Do not:**

- use batteries of different capacities
- mix old batteries with new
- mix batteries of different makes

The battery of the DCU and Float-free DRU have multiple cells. Batteries themselves may become damaged or damage to electrical parts may result.

 **Do not connect/disconnect the cable while turning the power on.**

The unit may be damaged.

About the TFT LCD

The TFT LCD is constructed using the latest LCD techniques, and displays 99.99% of its pixels. The remaining 0.01% of the pixels may drop out or blink, however this is not an indication of malfunction.

WARNING LABELS

Warning labels are attached to the DCU.

Do not remove the labels. If the label is missing or damaged, contact a FURUNO agent or dealer about replacement.

| |
|--|
|  WARNING  |
| To avoid electrical shock, do not remove cover. No user-serviceable parts inside. |
|  警告  |
| 感電の恐れあり。 サービスマン以外の方はカバーを開けないで下さい。内部には高電圧部分が多い数多くあり、万一さわると危険です。 |

Name: Warning Label 1
 Type: 86-003-1011-3
 Code No.: 100-236-233-10

TABLE OF CONTENTS

| | |
|--|-------------|
| FOREWORD | vi |
| SYSTEM CONFIGURATION | viii |
| 1. OPERATION | 1-1 |
| 1.1 Overview | 1-1 |
| 1.2 Operating Procedure | 1-5 |
| 1.2.1 How to turn the power on then record the data | 1-5 |
| 1.2.2 How to stop recording | 1-6 |
| 1.3 Operation on Remote Alarm Panel | 1-6 |
| 1.3.1 Start screen and base screen | 1-6 |
| 1.3.2 Controls | 1-7 |
| 1.3.3 How to adjust the brilliance of the LCD and keys | 1-7 |
| 1.3.4 Main menu overview | 1-8 |
| 1.3.5 How to extract the recorded data to an external media | 1-12 |
| 1.3.6 How to record the data to a USB flash memory | 1-15 |
| 1.3.7 How to execute SAVE function for recorded data (only for VR-7000S) | 1-15 |
| 1.3.8 Brilliance sharing function | 1-16 |
| 1.4 Alerts | 1-17 |
| 1.4.1 What is an alert? | 1-17 |
| 1.4.2 Alert list | 1-18 |
| 1.4.3 Alert icons and their meanings | 1-19 |
| 1.5 How to Release the Fixed DRU | 1-19 |
| 1.6 How to Release the Capsule from the Bracket of the Float-free DRU in Emergency Situation | 1-19 |
| 2. MAINTENANCE | 2-1 |
| 2.1 General Maintenance and Cleaning | 2-1 |
| 2.2 Maintenance of the Float-free DRU | 2-2 |
| 2.2.1 Notice for the maintenance and self test | 2-2 |
| 2.2.2 Monthly maintenance | 2-4 |
| 2.2.3 Normal self test | 2-6 |
| 2.2.4 Extended self test | 2-8 |
| 2.2.5 Annual Performance Test for the Float-free DRU | 2-10 |
| 2.2.6 Shore-Based Maintenance (SBM) | 2-10 |
| 2.3 Annual Recertification | 2-11 |
| 2.4 Fuse Replacement | 2-12 |
| 2.5 Consumable Parts | 2-13 |
| 2.6 Self Test | 2-13 |
| 2.7 Verification of Recording Function of the Long Term Device | 2-15 |
| 3. TROUBLESHOOTING | 3-1 |
| 3.1 General Troubleshooting | 3-1 |
| 3.2 Alert List | 3-1 |
| 3.2.1 Alert list for BAM mode | 3-1 |
| 3.2.2 Alert list for Legacy mode | 3-8 |
| 4. REMOTE PLAYBACK FUNCTION (LAND-SHIP COMMUNICATION) | 4-1 |
| 4.1 Preparations | 4-1 |
| 4.2 Limitations and Notifications | 4-1 |
| 4.3 Recommended Network Construction | 4-2 |

APPX. 1 MENU ITEMS.....AP-1
APPX. 2 PARTS LIST/LOCATIONAP-2
APPX. 3 LIST OF TERMS AND ABBREVIATIONS/SYMBOLSAP-5
APPX. 4 PLAYING BACK RECORDED DATAAP-7
SPECIFICATIONS SP-1

FOREWORD

A Word to the Owner of the VR-7000/7000S

Congratulations on your choice of the FURUNO Voyage Data Recorder (VDR) VR-7000/Simplified Voyage Data Recorder (S-VDR) VR-7000S. We are confident you will see why the FURUNO name has become synonymous with quality and reliability.

Since 1948, FURUNO Electric Company has enjoyed an enviable reputation for innovative and dependable marine electronics equipment. This dedication to excellence is furthered by our extensive global network of agents and dealers.

Your equipment is designed and constructed to meet the rigorous demands of the marine environment. However, no machine can perform its intended function unless properly installed and maintained. Please carefully read and follow the operation and maintenance procedures set forth in this manual.

We would appreciate feedback from you, the end-user, about where we are achieving our purposes.

Thank you for considering and purchasing FURUNO equipment.

What is a VDR?

A VDR records various data and events encountered aboard ship. The purpose of the VDR is to help investigators locate the causes of marine incidents.

The revised SOLAS Chapter V requires the installation of VDRs on passenger ships of 150 GT and above on all voyages and other ships of 3000 GT and above on international voyages and for newly built ships on and after 1 July, 2002.

The basic VR-7000/7000S consists of a Data Collecting Unit (DCU), a Data Recording Unit (DRU), a Remote Alarm Panel (RAP), a video LAN converter, a sensor adapter and microphones to record bridge audio. A Junction Box (JB) is optional. The DCU contains the Data Processor Unit, interface modules and backup batteries. It collects data from sensors as required by the IMO and IEC standards. The DCU processes the incoming data and information in the order of occurrence while old data is overwritten with new data for storage in the DRU for 48 hours. The batteries supply power to the DCU to record bridge audio for two hours in case of a ship's mains power failure.

The flash memory in the DRU stores the data coming from the DCU. All essential navigation and status data including bridge conversation, VHF communications, and radar images are recorded. The data can be retrieved by using playback software for investigation after an incident.

The Fixed DRU* components are embodied in a protective capsule. The capsule ensures survival and recovery of the recorded data after an incident. An acoustical pinger helps locate the Fixed DRU underwater.

The capsule of the Float-free DRU* is stored in the bracket. When the Float-free DRU sinks to depths of up to four meters, the capsule automatically comes off from the bracket then floats on the sea surface. At the same time, the capsule starts to transmit 406 MHz signal for locating the position of capsule and 121.5 MHz signal for homing for at least 168 hours.

*: Select one for VR-7000S.

Features

The main features of the VR-7000/7000S are as shown below.

- Color LCD with remote alarm panel.
- Complies with the following standards:
 - VR-7000: IEC 61996-1 Ed.2.1, IEC 61162-1 Ed.5.0, IEC 61162-2 Ed.1.0, IEC 61162-450 Ed.2.0, IEC 62288 Ed.2.1, IEC 60945 Ed.4.0, IEC 61924-2 Ed.1.0, IEC 62923-1/2 Ed.1.0
 - VR-7000S: IEC 61996-1 Ed.2.1, IEC 61996-2 Ed.2.0, IEC 61162-1 Ed.5.0, IEC 61162-2 Ed.1.0, IEC 61162-450 Ed.2.0, IEC 62288 Ed.2.0, IEC 60945 Ed.4.0, IEC 62923-1/2 Ed.1.0
- Reliable and fast data exchange between DCU and DRU via Ethernet.
- Fixed DRU and Float-free DRU with 48 hours recording.
- Compatible with remote maintenance.
- Recorded data can be analyzed and monitored on shore.
- Software updating from a PC connected to Ethernet.
- Long term device for storage (VR-7000: 720 hours recording, VR-7000S: 48 hours recording) and retrieval of data.

Program No.

- VR-7010 DCU: 2450102-01.XX
 - VR-7017 RAP: 2450103-01.XX
- XX: Minor change (For VR-7000S, XX is 10 or after for DCU, 06 or after for RAP.)

Note: When the VDR program version is “01.20” or later, Live Player V5 program version should be “01.10” or later. When the VDR program version is “01.20” or earlier, Live Player V5 program version should be “01.20” or earlier.

Fonts

The “iwata open type” font is used for the Remote Alarm Panel VR-7017.

Open Source Software

This product includes software to be licensed under the GNU General Public License (GPL), GNU Lesser General Public License (LGPL), BSD, MIT and others. For details about the term of use for these software, see the OSS license list on the supplied program CD (directory: \OSS_LicenseList\vdr).

The program(s) is/are free software(s), and you can copy it and/or redistribute it and/or modify it under the terms of the GPL or LGPL as published by the Free Software Foundation. Please access to the following URL if you need source codes: https://www.furuno.co.jp/cgi/cnt_oss_e01.cgi

Reverse engineering

Reverse engineering (disassemble, decompile) of the software of this equipment is strictly prohibited. However, reverse engineering is permitted under the following conditions:

- The library used for the reverse engineering (GNU Library General Public License Version 2, GNU Lesser General Public License Version 2.1, or later editions) is clearly noted.
- The reverse engineered software is used only within the scope outlined under the appropriate license.

Disclosure of Information about China RoHS

With regards to China RoHS information for our products, please refer to our website (www.furuno.com).

SYSTEM CONFIGURATION

Basic configuration is shown with solid line.

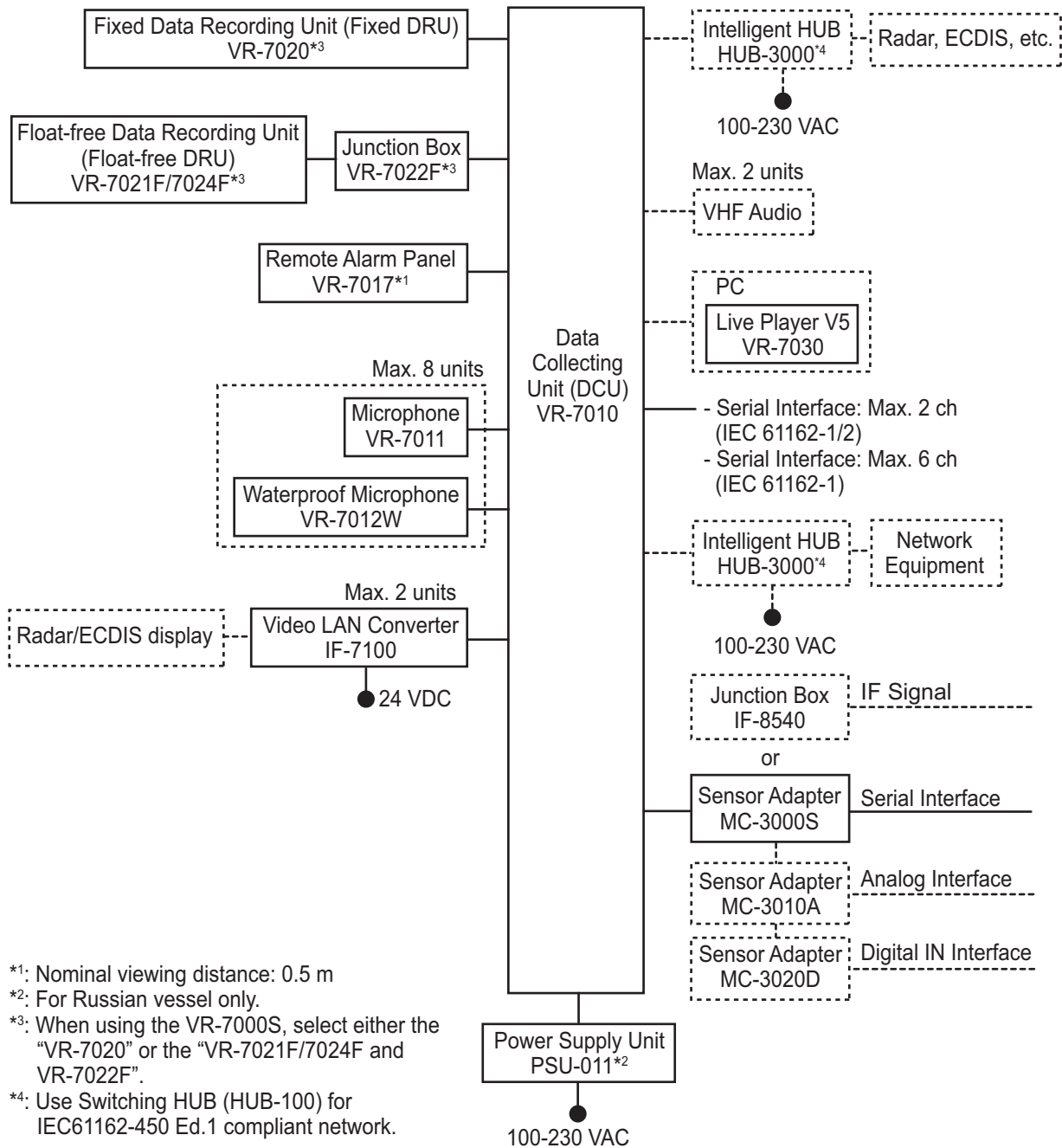

Environmental category

| | |
|---|----------------------------|
| All units (other than VR-7021F/7024F, VR-7022F, VR-7012W and VR-7020) | Protected from the weather |
| VR-7021F/7024F | Portable |
| VR-7022F, VR-7012W, VR-7020 | Exposed to the weather |

1. OPERATION

1.1 Overview

The VR-7000/7000S consists of a Data Collecting Unit (DCU), Data Recording Units (Fixed DRU and Float-free DRU), Remote Alarm Panel (RAP), Video LAN Converter, Sensor Adapter and bridge microphone units. The VDR system continuously stores data for 48 hours onto the Flash Memory in the capsule, erasing the oldest data stored as new data is recorded. The VDR mainly records the sentences shown in the table below.

Main sentences to be recorded

| Data to be recorded | IEC 61162 formatter |
|--------------------------------------|---------------------|
| Date and time | ZDA |
| Ship's position and datum used | GNS and DTM |
| Speed (water and/or ground) | VBW |
| Heading (true) | HDT |
| Heading (magnetic) | HDG |
| AIS-VHF data-link message | VDM |
| AIS-VHF data-link own-vessel message | VDO |
| Depth (echo sounder) | DPT |
| Alerts and Alarms | ACN, ALC, ALF, ALR |
| Rudder sensor angle | RSA |
| Rudder order status | ROR |
| Heading/track control command | HTC |
| Heading/track control data | HTD |
| Engine order/response | RPM, XDR |
| Hull openings, watertight doors | XDR |
| Accelerations and hull stress | HSS, XDR |
| Wind speed and direction | MWV |
| VDR alert output | ALF, ALC |
| Heartbeat supervision sentence | HBT |

Power supply precaution

If ship's mains power source (100-230 VAC) and emergency source fail, the VR-7000/7000S continues to record bridge audio for two hours from backup batteries.

Continuity of storing data

The VDR should be provided with power to store data for over 48 hours (for Fixed DRU and Float-free DRU) or over 720 hours (for long term device of the DCU) on a first-in, first-out basis. Recording is terminated only under the following conditions:

- During essential maintenance while the vessel is in port.
- When the vessel is laid-up.

Data Collecting Unit

The DCU mainly consists of a Data Processor Unit and Power Control Panel. The DCU includes batteries with a lifetime of approximately four years. The DCU collects the data from various sensors radar/ECDIS and records them in the Fixed DRU, Float-free DRU and internal long term device.

Recording interval of data and audio is as follows:

- Radar/ECDIS video signal: every 15 seconds
- Bridge and VHF audio: real time
- IEC sentences: when received
- Analog and digital data: every second

For VR-7000, you can select one or two 512-GB SSD(s) as internal long term device(s). When selecting one SSD, you can add another one using an optional SSD kit later.

| No. of pcs | Storage time | Video signal channels recorded at the same time |
|----------------|--------------|---|
| 1 SSD (512 GB) | 720 hours | Up to 5 channels* |
| 2 SSDs (1 TB) | | Up to 6 channels* |

*: The recording interval for 3 channels is 15 seconds, which is compliant with IEC61996-1 Ed.2.1 and IEC61996-2 Ed.2.0. Other channels record a maximum of four video signals at intervals of 15 seconds, using the time-division method.

For VR-7000S, there are four save areas (Area1, 2, 3, 4) in the long term device(s). Each area can record data for 12 hours.

Data Recording Unit

Fixed DRU

The Fixed DRU is housed in a highly visible protective capsule which can withstand a fire of 1,100°C for one hour and deep-sea pressure of 6,000 m.

The underwater acoustic beacon (pinger) on the capsule automatically transmits 10 ms pulses at 37.5 kHz for at least 90 days when it is submerged in water. The expected life of the beacon battery is three years.

Float-free DRU

The capsule of the Float-free DRU has the same functionality of an satellite EPIRB (Emergency Position-Indicating Radio Beacon). The VDR data is recorded in the storage module at the bottom of capsule.

The DCU feeds the VDR data to the bracket of the Float-free DRU through the LAN cable, then the bracket feeds the data to the capsule by wireless communication.

The capsule of the Float-free DRU is stored in the bracket. When the Float-free DRU sinks to depths of up to four meters, the capsule is automatically released from the bracket then floats to the sea surface. At the same time, the capsule starts to transmit 406 MHz signal for locating the position of capsule, 121.5 MHz signal for homing and AIS messages (VR-7024F only) for at least 168 hours.

Note: Select fixed DRU or float-free DRU for VR-7000S.

Data items to be recorded

Note: If the sensor data is input to the DCU through an external unit (sensor adapter, junction box, etc.), the input of the sensor data is delayed because of the communication lag between the DCU and external unit.

Date and time: Date and time are obtained from an external GPS navigator referenced to UTC. When an external GPS navigator is not available, a signal is recorded with a built-in clock in the DCU.

Ship's position and datum used: Latitude, longitude and datum are obtained from a GPS navigator, Loran-C receiver or other EPFS or INS available on standard serial interface. The source of data is identifiable on playback.

Speed (water and/or ground): Speed through the water (STW) or speed over the ground (SOG) is recorded. The resolution is 0.1 kn. Transverse speed is also indicated when available on board.

Heading (true, magnetic): Heading is recorded to a resolution of 0.1°. The data is labeled G (gyrocompass), GPS, GLONASS, MAG. If heading information is not available in IEC 61162 format, an appropriate interface may be necessary.

Depth (echo sounder): Depth under keel up to a resolution of 0.1 m as available on the ship is recorded.

Alarms: The status of all IMO mandatory alarms is recorded individually with ID number and time stamp. Audible alarms from the alarm units are stored simultaneously by the bridge audio microphones.

Rudder order/response: Rudder order and response angles are recorded up to a resolution of 1° as available on the ship. The rudder information is recorded. If more than one rudder is provided, the circuitry can be duplicated.

Engine order/response: The DCU obtains the engine order and response from the engine telegraph or direct engine control. The engine parameters with shaft revolution and ahead/astern indicators are recorded to a resolution of 1 rpm. All order and response from bow, stern, thruster, tunnel thrusters and controllable pitch propellers shall be recorded.

Hull openings, watertight doors: Digital and serial signals can be input individually. The data is stored with time stamps.

Accelerations and hull stresses: The DCU obtains signals from appropriate hull stress and response monitoring devices. The inputs are recorded individually and stored with time stamps.

Wind speed and direction: The DCU obtains the signal from appropriate wind speed and direction sensor. The inputs are recorded individually and stored with time stamps. The wind speed resolution is 1 unit (1 kn, 1 m/s, etc.). The wind direction resolution is 1°.

VDR alarm output: If, as an option, such messages are sent then the appropriate sentence formats are ALF and ALC.

Radar/ECDIS data: Radar/ECDIS image is recorded in the Fixed DRU, Float-free DRU and long term device via the LAN or the video LAN converter. Range rings, EBLs, VRMs, plotting symbols, radar maps, parts of SENC, voyage plan, and other essential navigational indications are included in the recorded radar image. Own

1. OPERATION

ship's mark and position (latitude and longitude), course, speed, voyage plan, and other essential navigational indications are included in the recorded ECDIS image. One complete picture frame is captured at intervals of 15 s. Scanning may be interlaced or non-interlaced.

The channel number and resolution can be recorded is shown in the table below.

| Input method | No. of pcs | Resolution/Max. channel number |
|--|----------------|---|
| Inputs through the video LAN converter | 1 SSD (512 GB) | UXGA (1600×1200): 2 ch + Full HD (1920×1080): 1 ch |
| | 2 SSDs (1 TB) | UXGA (1600×1200): 2 ch + Full HD (1920×1080): 1 ch + WUXGA (1920×1200): 1 ch* |
| IEC61162-450 format | 1 SSD (512GB) | For PNG format: UXGA (1600×1200): 2 ch + Full HD (1920×1080): 1 ch For JPEG format (quality is 50 or above): WUXGA (1920×1200): 3 ch For JPEG format (quality is less than 50): WUXGA (1920×1200): 5 ch |
| | 2 SSDs (1TB) | For PNG format: UXGA (1600×1200): 2 ch + Full HD (1920×1080): 1 ch + WUXGA (1920×1200): 1 ch* For JPEG format (quality is 50 or above): WUXGA (1920×1200): 3 ch + WUXGA (1920×1200): 1 ch* For JPEG format (quality is less than 50): WUXGA (1920×1200): 5 ch + WUXGA (1920×1200): 1 ch* |

*: Recorded to the long term device (SSD) only. Not recorded to the Fixed DRU and Float-free DRU.

Bridge audio: Up to eight microphones are supplied as standard to record conversation at conning station, radar display and chart table. Microphone captures conversation in the bridge, audio signals from equipment and sound from machinery. The microphone generates a test beep every 12 hours which is also recorded. The microphone picks up audio signals ranging from 150 to 6000 Hz.

Communications audio: A maximum of two VHF communications are recorded for both transmitted and received audio signals.

Minimum data retention period

The VDR data is retained in the recording media, following termination of recording. The minimum data retention periods for each recording unit are shown in the table below (IEC61996-1/IEC61996-2 compliant).

| Unit | Minimum Data Retention Period |
|------------------------|-------------------------------|
| Long term device (DCU) | 2 years after recording |
| Fixed DRU | |
| Float-free DRU | 6 months after recording |

1.2 Operating Procedure

1.2.1 How to turn the power on then record the data

Data Collecting Unit

NOTICE

Do not open the DCU door unless authorized to do so.

The DCU comes with a key to protect against any unauthorized access. The key must be kept securely by authorized personnel.

To start recording, open the DCU door with its key and turn on the AC and BATTERY switches in that order on the power control panel. Confirm that the AC SUPPLY MAINS LED and BATTERY BACKUP LED on the power control panel light. Data is automatically recorded in the Fixed DRU*, Float-free DRU* and long term device.

*: Select one for VR-7000S.

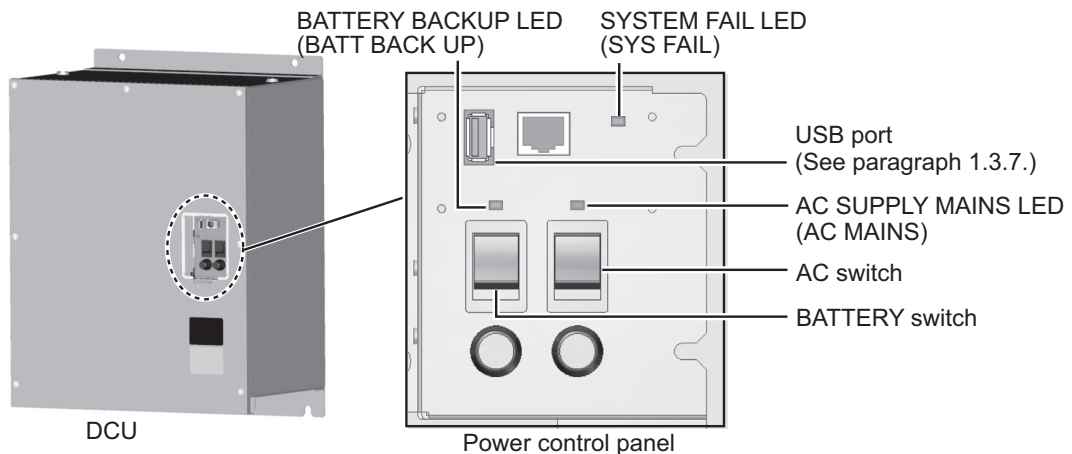

Note 1: When turning the power on at temperatures of 0 °C or lower, the DCU must be warmed before it can be operated, which takes a maximum of 30 minutes. The error message may appear on the screen of the VR-7017, however, this is not abnormal.

Note 2: If the VR-7000/7000S system fails to start, it may be restarted.

Note 3: Do not turn off the DCU power for 30 seconds after the power is turned on. Recorded data can be corrupted.

Note 4: Do not exert force on the opened DCU door. Force can damage the door.

Note 5: Do not connect multiple USB flash memories to the USB port via a USB HUB.

Video LAN Converter (IF-7100)

The video LAN converter converts the radar video signal to the LAN signal.

Turn the power on/off for the IF-7100 and the equipment connected to the IF-7100 (i.e. processor unit for radar or ECDIS) in the following order. Otherwise the IF-7100 may not function properly.

Power-on: Turn on the IF-7100 and the connected equipment in that order.

Power-off: Turn off the connected equipment and the IF-7100 in that order.

Note: The IF-7100 does not have a power switch. Turn off the IF-7100 from the main switchboard.

1.2.2 How to stop recording

Recording is terminated only under the following conditions:

- During essential maintenance while the vessel is in port.
- When the vessel is laid-up.

To stop recording, open the DCU door with its key and turn off the BATTERY and AC switches in that order. DO NOT turn off the system by the main breaker while the BATTERY switch is on. If only the AC switch is turned off, the system operates on the batteries. The system stops after recording the audio data only for two hours. When the AC power is supplied to the DCU again, the batteries are charged. The BATTERY BACKUP LED flashes while charging the batteries.

Note: After the power to the DCU is turned off, wait at least 10 seconds before reapplying the power. The DCU may not function correctly.

1.3 Operation on Remote Alarm Panel

1.3.1 Start screen and base screen



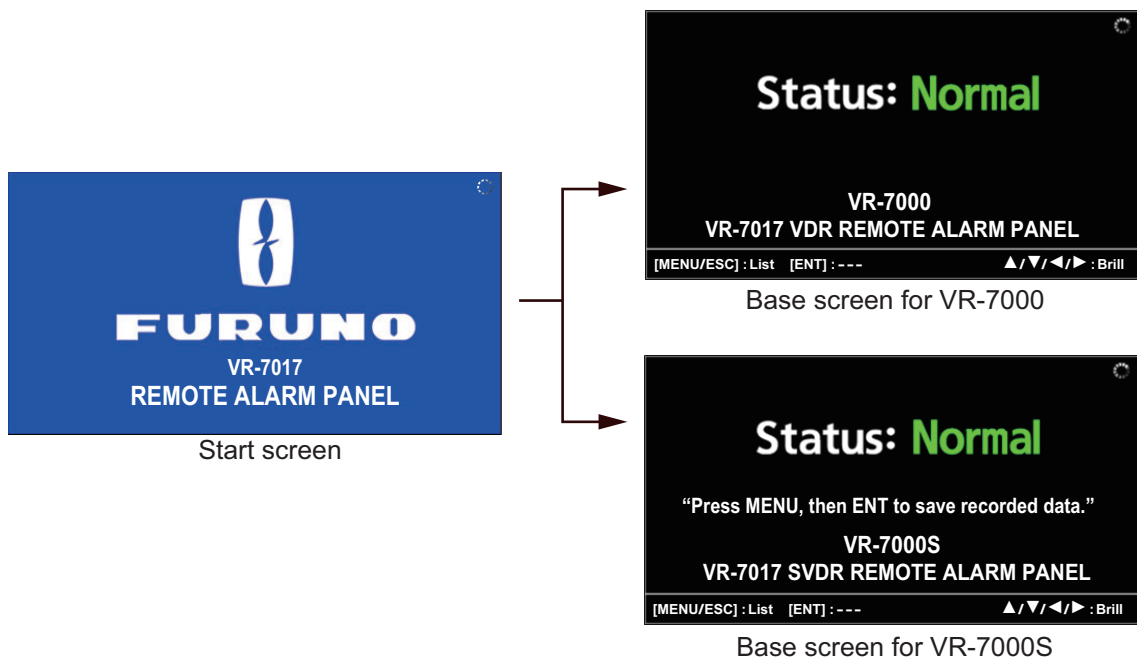



No power switch is provided on the Remote Alarm Panel; it is turned on and off by the power switch on the DCU. After the boot program screen appears, the start screen appears followed by the base screen.



Note: When the DCU does not boot normally, it takes a maximum of 10 minutes to display the base screen. The error message "Lost DCU" ("No DCU connection" for Legacy mode) appears on the screen.

1.3.2 Controls



| Control | Function |
|--|--|
|  BRILL | Short press: Displays the [BRILL] setting window. Long press: Restores the brilliance of the LCD and keys to default. |
|  ACK | BAM mode: Not used. Legacy mode: Acknowledge an alert to stop the flashing of the alert list and silence the alert buzzer. |
|  TEST | Opens the test menu. |
|  Extract | Extracts the recorded data to the external media. |
|  MENU/ESC | Short press: Opens/closes the menu, returns one layer in menu operation. Long press: When one or more alerts are active, opens the alert list. When no active alert exists, returns to the base screen except in pop-up displays (e.g. key beep, extraction related, etc.) and tests. |
|  ENT | <ul style="list-style-type: none"> • Confirms a selection. • Legacy mode only: Silences the alert buzzer temporarily when there are unacknowledged alerts. (The alert buzzer sounds again in 30 seconds after the buzzer stops.) |
|  Cursorpad | Short press: Selects a menu item, switches the page, adjusts the brilliance of the LCD and keys when the [BRILL] setting window opens. Long press: Moves the cursor continuously. |

1.3.3 How to adjust the brilliance of the LCD and keys

1. Press the **BRILL** key to show the [BRILL] setting window.

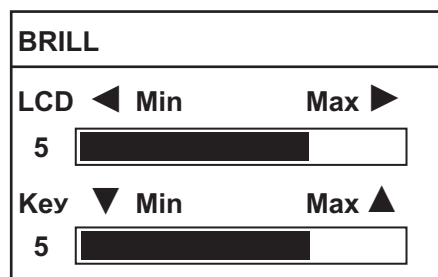

Setting ranges: 0 to 7
Defaults: 5

2. To adjust the brilliance, use the cursorpad; ◀ or ▶ for the LCD, ▲ or ▼ for the keys.
3. Press the **ENT** or **MENU/ESC** key to close the setting window.

1.3.4 Main menu overview

1. Press the **MENU/ESC** key to open the main menu on the base screen or alert list.
2. Use the cursorpad (**▲** or **▼**) to select a menu item then press the **ENT** key.

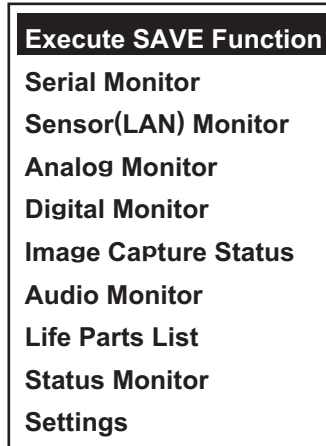

← Only for VR-7000S

[Serial Monitor]

You can monitor the sensor information input to the serial channels.

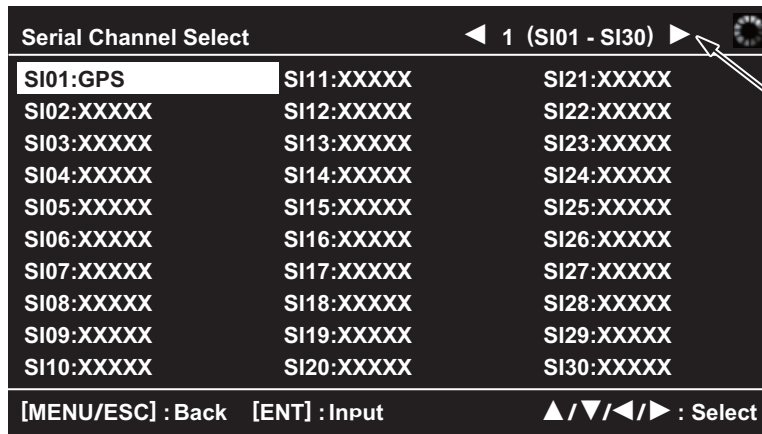

To shift the page, use the cursorpad (**◀** or **▶**).

To see the information for a serial channel, use the cursorpad to select a serial channel (SI01 to SI16) then press the **ENT** key to show the serial monitor screen. The latest received data is displayed on the top of the screen.

Note: A serial channel whose number is SI17 or later is no use.



To switch the channel, use the cursorpad (**◀** or **▶**).

Press the **ENT** key to stop the serial display. To restart the serial display, press the **ENT** key again.

[Sensor(LAN) Monitor]

You can monitor the sensor information input to the LAN channels.

| Sensor(LAN) Channel Select | | |
|----------------------------|-------------|-------------|
| ◀ 1 (LN01 - LN30) ▶ | | |
| LN01:GPS | LN11:XXXXXX | LN21:XXXXXX |
| LN02:XXXXXX | LN12:XXXXXX | LN22:XXXXXX |
| LN03:XXXXXX | LN13:XXXXXX | LN23:XXXXXX |
| LN04:XXXXXX | LN14:XXXXXX | LN24:XXXXXX |
| LN05:XXXXXX | LN15:XXXXXX | LN25:XXXXXX |
| LN06:XXXXXX | LN16:XXXXXX | LN26:XXXXXX |
| LN07:XXXXXX | LN17:XXXXXX | LN27:XXXXXX |
| LN08:XXXXXX | LN18:XXXXXX | LN28:XXXXXX |
| LN09:XXXXXX | LN19:XXXXXX | LN29:XXXXXX |
| LN10:XXXXXX | LN20:XXXXXX | LN30:XXXXXX |

[MENU/ESC] : Back [ENT] : Input ▲/▼/◀/▶ : Select

To shift the page, use the cursorpad (◀ or ▶).

To see the information for a sensor(LAN) channel, use the cursorpad to select a sensor(LAN) channel (LN01 to LN64) then press the **ENT** key to show the sensor (LAN) monitor screen. The latest received data is displayed on the top of the screen.

| Sensor(LAN) Monitor | |
|---|--|
| ◀ LN01 ▶ | |
| \$GPZDA.104523.4582.23.12.2012.09.00-54 | |
| \$GPGNS.104523.477.3434.000.N.13510222.E.N.01.1.1.5.0.-2.3.4.1.0-3A | |
| \$GPDTM.W84.0.0.1.N.1.0.W.2.0.W72-46 | |
| \$GPVTG.176.T.180.0.M.1.0.N.1.8.K.A-3C | |

[MENU/ESC] : Back [ENT] : Stop ◀/▶ : Select

To switch the channel, use the cursorpad (◀ or ▶).

Press the **ENT** key to stop the sensor display. To restart the sensor display, press the **ENT** key again.

[Analog Monitor]

You can monitor the sensor information input to the analog channels (AN001 to AN120).

| Analog Monitor | |
|-----------------------|-----------------|
| ◀ 1 (AN001 - AN016) ▶ | |
| AN001: - 0. 04V | AN009: - 2. 12V |
| AN002: 1. 23mA | AN010: 3. 48V |
| AN003: 0. 50V | AN011: 2. 10V |
| AN004: - 1. 00V | AN012: - 0. 90V |
| AN005: 0. 23mA | AN013: 6. 17mA |
| AN006: - 1. 11V | AN014: 4. 39mA |
| AN007: 0. 45mA | AN015: 2. 25V |
| AN008: 2. 50V | AN016: 1. 04V |

[MENU/ESC] : Back ◀/▶ : Select

To switch the channel, use the cursorpad (◀ or ▶).

1. OPERATION

[Digital Monitor]

You can monitor the sensor information input to the digital channels (DC001 to DC640).

| Digital Monitor | | | |
|-----------------------|----------|----------|----------|
| ◀ 1 (DC001 - DC032) ▶ | | | |
| DC001: 1 | DC009: 1 | DC017: 1 | DC025: - |
| DC002: 1 | DC010: 1 | DC018: 1 | DC026: - |
| DC003: 0 | DC011: 0 | DC019: 0 | DC027: - |
| DC004: 0 | DC012: 0 | DC020: 0 | DC028: - |
| DC005: 1 | DC013: 1 | DC021: 1 | DC029: - |
| DC006: 1 | DC014: 1 | DC022: 1 | DC030: - |
| DC007: 0 | DC015: 0 | DC023: 0 | DC031: - |
| DC008: 1 | DC016: 1 | DC024: 1 | DC032: - |

[MENU/ESC] : Back ◀/▶ : Select

To switch the channel, use the cursorpad (◀ or ▶).

[Image Capture Status]

You can monitor the information of the images recorded in the DCU. The information for the image captures (the time and date when the image is captured to the VDR, captured image size, etc.) are updated.

| Image Capture Status | | |
|--|--|--|
| ◀ 1 / 2 ▶ | | |
| Radar1 | Radar2 | ECDIS |
| Captured Time: 01/09/2014 10:30:20 | Captured Time: 01/09/2014 10:30:20 | Captured Time: 01/09/2014 10:30:20 |
| Source: Xband.1 | Source: Sband.1 | Source: ECDIS.1 |
| Location: MFD0 | Location: MFD0 | Location: MFD0 |
| Active: Yes | Active: Yes | Active: Yes |
| Resolution: 1280x1024 | Resolution: 1280x1024 | Resolution: 1280x1024 |

[MENU/ESC] : Back ◀/▶ : Page

To switch the page, use the cursorpad (◀ or ▶).

[Audio Monitor]

You can check the status of the microphones and communications equipment (VHF, etc.).

| Audio Monitor | | | | |
|------------------------------|------------------------------|------------------------------|------------------------------|------------------------------|
| VHF1 | VHF2 | MIC1 | MIC2 | MIC3 |
| Status: --- | Status: --- | Status: MIC TestOK | Status: MIC TestNG | Status: Not Connected |
| Level: □□□□ | Level: □□□□ | Level: ■■■■■ | Level: ■■□□ | Level: □□□□ |
| MIC4 | MIC5 | MIC6 | MIC7 | MIC8 |
| Status: MIC TestOK | Status: MIC TestNG | Status: MIC TestNG | Status: Not Connected | Status: MIC TestOK |
| Level: ■■□□ | Level: ■■□□ | Level: ■□□□ | Level: □□□□ | Level: ■■□□ |

[MENU/ESC] : Back ◀/▶ : ---

← Microphone/VHF volume level

[Life Parts List]

You can check the lifetimes of the parts.

| Life Parts List | | |
|--------------------|--------|-------------|
| Type No. | Status | Expiry Date |
| VR-7020 Acoustic B | OK | 2014/08 |
| VR-7024F HRU | OK | 2014/08 |
| VR-7024F Battery M | OK | 2014/08 |
| VR-7010 Battery | OK | 2014/08 |

When there are multiple pages, use the cursorpad (◀ or ▶) to shift the page.

[MENU/ESC] : Back

[Status Monitor]

You can see the status of the system. Page 2 is only for VR-7000S.

| Status Monitor | | |
|-----------------------------|--------------------------------|--|
| VDR Version : 2450102-01.XX | SYS Time : 10/05/2014 17:45:20 | |
| RAP Version : 2450103-01.XX | UTC Time : 10/05/2014 17:45:19 | |
| | DIFF Time : 01 sec | |

[MENU/ESC] : Back

| Status Monitor | | |
|----------------|---|-------------|
| AreaNumber | Start-End | TrackNumber |
| Area1 | 01/06/2016 17:20:30-01/06/2016 05:20:30 | 01 |
| Area2 | 03/06/2016 23:10:15-03/06/2016 11:10:15 | 01 |
| Area3 | 07/06/2016 19:30:50-07/06/2016 07:30:50 | 01 |
| Area4 | 10/06/2016 10:40:20-09/06/2016 22:40:20 | 01 |

[MENU/ESC] : Back

[Settings]

The [Settings] menu has menu items for the key beep sound and the brilliance sharing function.

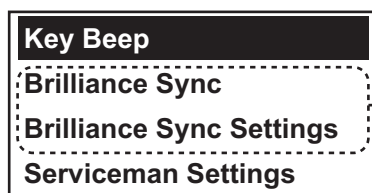

Shown when the brilliance sharing function is enabled at installation.

- [Key Beep]: When you operate a key, a single beep sounds. If you do not need the key beep, you can deactivate the beep sound. Use the cursorpad (◀ or ▶) to select [OFF] then press the **ENT** key.
- Key Beep**

ON
OFF
- [Brilliance Sync]: Turn the brilliance sharing function on or off. For details of the brilliance sharing function, see section 1.3.8.
 - [Brilliance Sync Settings]: Adjust the preset setting value for the brilliance sharing. For details of the brilliance sharing function, see section 1.3.8.
 - [Serviceman Settings]: No use.

1.3.5 How to extract the recorded data to an external media

Do the following to extract data to a USB flash memory.

Note 1: Do not remove the long term device(s) from the DCU unless authorized to do so. Extract the recorded data to the external media (a USB, etc.).

Note 2: To ensure smooth extraction of data to a USB flash memory, do the extraction when the ship is stopped. Vibration, pitching, rolling, etc. can prevent smooth extraction.

Note 3: All data in a USB flash memory is deleted.

Note 4: Use a USB flash memory formatted with FAT32. The USB flash memories in the following table have been tested:

| Manufacturer | Model | Capacity |
|---------------|-----------------|----------|
| Silicon Power | MARVELMO116GB | 16 GB |
| HIDISK | HDF101S128G3 | 128 GB |
| TOSHIBA | UHYBS-032GH | 32 GB |
| SanDisk | SDCZ33-064G-J57 | 64 GB |
| I/O DATA | U3-AL16G | 16 GB |
| | U3-AL8G | 8 GB |
| ELECOM | MF-MSU3A04G | 4 GB |
| | MF-TKU3016G | 16 GB |
| UNISERB | PEUSB2-32G | 32 GB |
| SONY | USM8GT | 8 GB |
| BUFFALO | UF3-K8GB | 8 GB |

Note 5: Remove the USB flash memory only after the extraction is completed. Removing it during extraction may corrupt data in the next extraction. Further, abnormal data is played back.

Note 6: Do not extract the recorded data using the following steps when recording the data in the USB flash memory as the user disk. Extract the recorded data using the Live Player V5.

1. Open the DCU door with its key.
2. Insert a USB flash memory to the USB port.
3. Press the **Extract** key on the RAP.

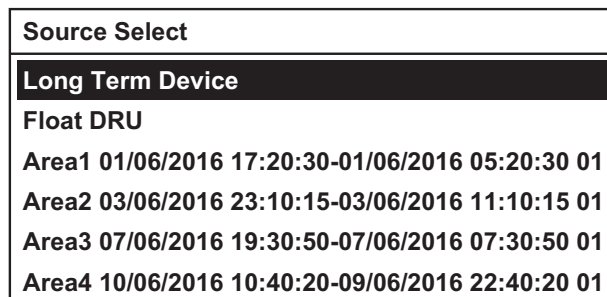
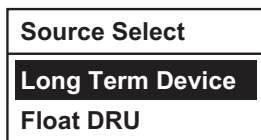

VR-7000S

4. Use the cursorpad (▲ or ▼) to select the data source from [Long Term Device], [Float DRU] or [Area1 (2, 3, 4)] (only for VR-7000S) then press the **ENT** key.
 - [Long Term Device]: Long term device(s) in the DCU
 - [Float DRU]: Float-free DRU
 - [Area1 (2, 3, 4)]: Area1 to Area4 of long term device(s) in the DCU

Note 1: This function is not available for a Fixed DRU.

Note 2: Do not select [Float DRU] unless you can not extract the data from the long term device(s).

After selecting the data source, the following menu appears.

| |
|-------------------------------------|
| Extract Mode Select |
| Target Date and Time Specify |
| Extract Period Select |

5. Use the cursorpad (▲ or ▼) to select [Target Date and Time Specify] or [Extract Period Select] then press the **ENT** key.
 - [Target Date and Time Specify]: Specify the date and time for the data to be extracted.
 - [Extract Period Select]: Set the extraction time.
6. Do the following procedure according to the menu option that is selected at step 5.
 - [Target Date and Time Specify] is selected at [step 5](#)
The following setting window appears.

| |
|--|
| Target Date and Time Specify |
| ▲ 16 / 04 / 2019 15 : 20 ▼ DD MM YYYY hh mm |

- 1) Use the cursorpad to specify the date for the data to be extracted then press the **ENT** key.

| |
|--|
| Target Date and Time Specify |
| ▲ Range: +- 1 hour ▼ (1~6) hour |

- 2) Use the cursorpad to select the extraction time then press the **ENT** key.
The data for the setting hours before and after the date specified at the previous step is extracted.

After setting the extraction time, the following window appears.

| |
|--|
| Target Date and Time Specify |
| 16/04/2019 15:20 +- 1 hour OK : [ENT] / Cancel : [ESC] |

- 3) Press the **ENT** key.

1. OPERATION

- [Extract Period Select] is selected at [step 5](#)
The setting window as shown to the right appears. Use the cursorpad (**▲** or **▼**) to set the extraction time* (1 to 12 hour(s)) then press the **ENT** key.
*: Backdated data is extracted, starting from the moment the **ENT** key was pressed.

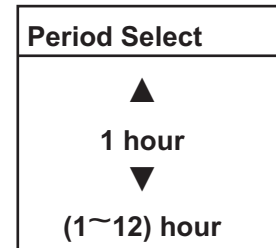

After setting the extraction time, the following window that indicates the extraction data size and disk space appears.

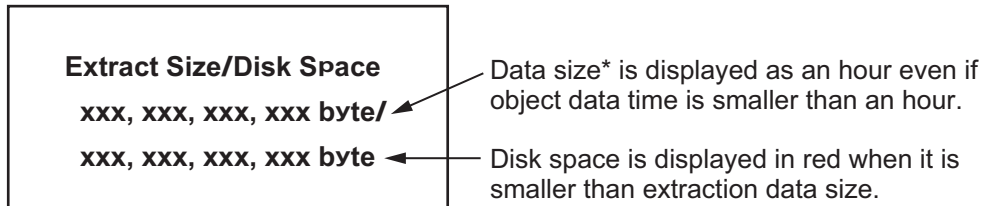

*: "0 byte" may be displayed when the specified extraction period includes the time zone that does not have recorded data. Even if the data size is "0 byte", perform the following steps. The data may be extracted if the recorded data is included in specified extraction period.

Note: If the following window appears, check that the USB flash memory is properly inserted and is formatted to FAT32. Then press the **ENT** key and restart the procedure from step 4.

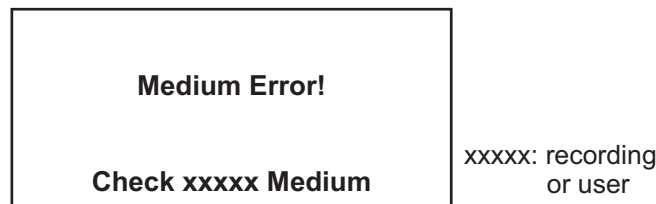

7. Press the **ENT** key. The confirmation window appears.



8. Use the cursorpad (**◀** or **▶**) to select [Yes] then press the **ENT** key. The window changes as follow.

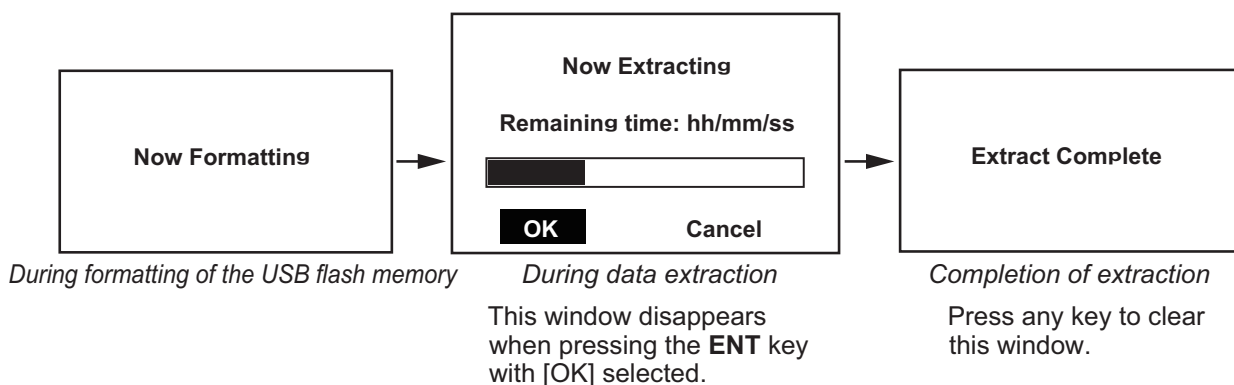

Note 1: If an error occurs during the formatting of the USB flash memory, the message "Format Error! Extract Canceled" appears. Press any key to clear the message then check the USB flash memory.

Note 2: If an error occurs during data extraction or there is no recorded data, the message "Extract Error! Extract Canceled" appears.

9. Lock the DCU door after the data is extracted.

1.3.6 How to record the data to a USB flash memory

Data which is recorded to the capsule can be recorded to a USB flash memory as the user disk. Insert a USB flash memory to the USB port on the power control panel (see subsection 1.2.1). The recording time is from 72 to 720 hours, at 72 hours intervals. Have a qualified technician initialize USB flash memory before use. For details, contact your dealer.

During recording to a USB flash memory, if alert numbers 412504 or 412514 occur (see section 3.2), remove then reconnect the USB flash memory. If the error occurs again during recording, contact your dealer for service.

Note: Do not use the RAP to record data when recording to a USB flash memory.

1.3.7 How to execute SAVE function for recorded data (only for VR-7000S)

If marine incidents occur, record the data, which are recorded to the capsule, to area1 (or 2, 3, 4) in the long term device(s). When all areas are used, the memory for the oldest area is automatically overwritten with the new memory in order from the oldest area.

1. Press the **MENU/ESC** key to open the main menu.
2. Use the cursorpad (**▲** or **▼**) to select [Execute SAVE Function] then press the **ENT** key. The window changes as follow.

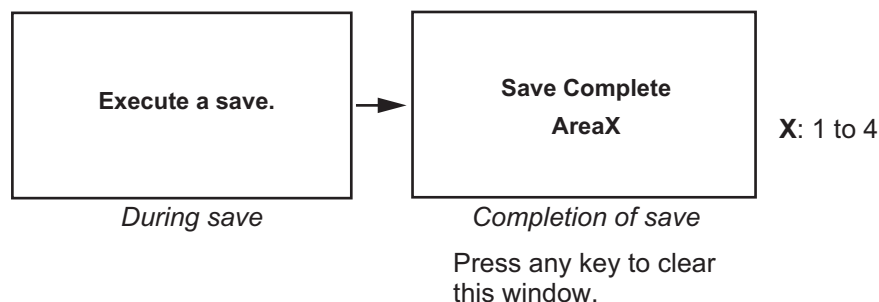

Note 1: If the save processing fails, the message "Save Error" appears. When the save processing can not be executed, the message "DCU setting to be checked for SAVE function." appears. When this message appears, contact your dealer.

Note 2: The recording to the long term device(s) does not stop when all areas are used.

Note 3: The SAVE execution does not affect the recording operation for the long term device(s) or the connected DRU.

1.3.8 Brilliance sharing function

The RAP can share the brilliance settings with EC-3000/3005 units (ex: ECDIS, chart radar) in the same network. When you adjust the brilliance of the EC-3000/3005 units, the brilliance of the RAP is automatically changed. Note that the brilliance of the EC-3000/3005 units is not changed according to the RAP brilliance change.

To turn the brilliance sharing function on or off, do as follows.

Note: The VDR software version must be “01.40” or after to use the brilliance sharing function. Also, it is required to enable the function from the service menu. For details, contact your dealer.

1. Press the **MENU/ESC** key to open the main menu.
2. Use the cursorpad (**▲** or **▼**) to select [Settings] then press the **ENT** key.

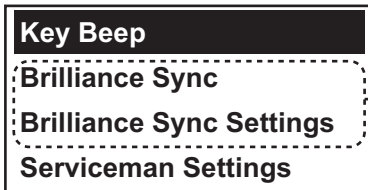

Shown when the brilliance sharing function is enabled at installation. To enable the function, contact your dealer.

3. Use the cursorpad (**▲** or **▼**) to select [Brilliance Sync] then press the **ENT** key.

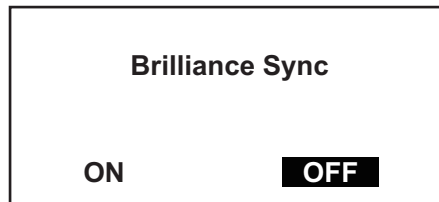

4. Use the cursorpad (**◀** or **▶**) to select [ON] or [OFF] then press the **ENT** key. To turn the brilliance setting function, select [ON].
5. Use the cursorpad (**▲** or **▼**) to select [Brilliance Sync Settings] then press the **ENT** key.
6. Adjust the preset brilliance of the LCD and keys for the day, dusk and night.

| Brilliance Sync Settings | | |
|--------------------------|-----|-----|
| | LCD | Key |
| Day | 5 | 5 |
| Dusk | 4 | 4 |
| Night | 3 | 3 |

→
Select [Day], [Dusk] or [Night], then press the **ENT** key.

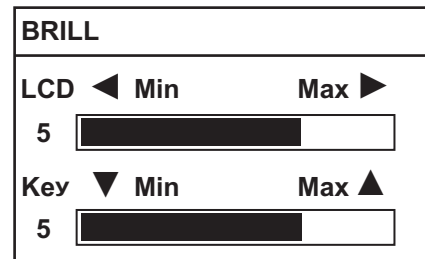

1.4 Alerts

1.4.1 What is an alert?

“Alert” is a generic name for a notice to any unusual or potentially dangerous situation generated within the system.

For detailed information regarding specific alerts and alert codes, including possible remedies, see section 3.2.

Alerts are classified according to priority and category.

Note 1: This equipment does not provide the functional alert group function.

Note 2: The reserved cluster identifier for this equipment, which is defined in IEC62923-2 is “Nav”.

Alert priority

The level of priority, from highest to lowest, is ALARM → WARNING → CAUTION.

Alarm: Situations or conditions which require immediate attention, decision and (if necessary) action by the bridge team to avoid any kind of hazardous situation and to maintain the safe navigation of the ship.

Warning: Conditions or situations which require immediate attention for precautionary reasons, to make the bridge team aware of conditions which are not immediately hazardous, but may become so.

Caution: Awareness of a condition which continues to require attention out of the ordinary consideration of the situation or of given information.

Note: This equipment does not generate Alarm priority alerts.

Alert category

An alert is further classified by category, A, B or C, according to its degree of severity or source.

| Category | Description |
|----------|--|
| A | Category A alerts include the following, and must be confirmed from the equipment that generated the alert. <ul style="list-style-type: none"> • Danger of collision Category A alerts are not shown on this equipment. |
| B | Category B alerts are alerts where no additional information for decision support is necessary. Category B alerts are all alerts not falling under category A. |
| C | IAS (Integrated Automation System) generated engine alert Category C alerts are not shown on this equipment. |

1.4.2 Alert list

When an alert condition is found, the alert list opens and provides information about active alerts. The list shows

- Alert icon
- Alert name
- Alert ID*1
- Time*2 (UTC) alert was acknowledged

*1: This equipment cannot display the alert instance ID.

*2: The date and time of alert is synchronized with UTC, using the ZDA sentence. If the ZDA sentence is lost, the date and time cannot be synchronized with UTC.

This indication flashes when one or more alerts are active.

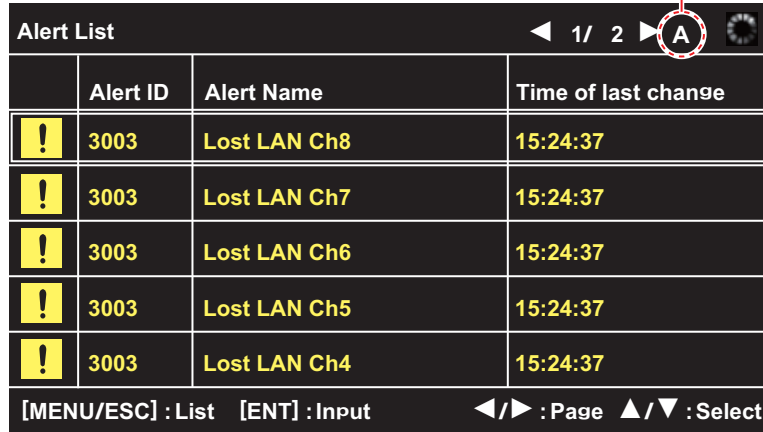

| Alert List | | | |
|------------|----------|--------------|---------------------|
| | Alert ID | Alert Name | Time of last change |
| ! | 3003 | Lost LAN Ch8 | 15:24:37 |
| ! | 3003 | Lost LAN Ch7 | 15:24:37 |
| ! | 3003 | Lost LAN Ch6 | 15:24:37 |
| ! | 3003 | Lost LAN Ch5 | 15:24:37 |
| ! | 3003 | Lost LAN Ch4 | 15:24:37 |

[MENU/ESC] : List [ENT] : Input ◀▶ : Page ▲▼ : Select

The list has multiple pages when more than five alerts are active. To view other alerts, use the cursorpad (◀ or ▶). The flashing cycle is 0.5 seconds.

Note: If a new alert occurs or alert status is changed while displaying the page 2 or after, the page 1 of the alert list opens automatically to show the high priority alert.

To see the detailed information for an alert, use the cursorpad (▲ or ▼) to select the alert then press the **ENT** key.

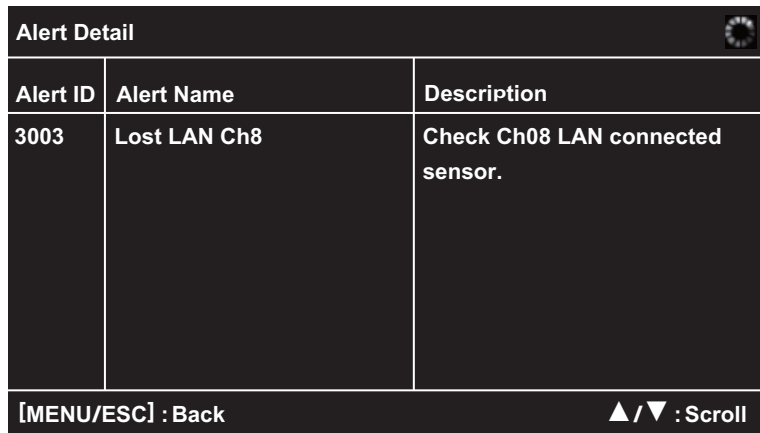

| Alert Detail | | |
|--------------|--------------|----------------------------------|
| Alert ID | Alert Name | Description |
| 3003 | Lost LAN Ch8 | Check Ch08 LAN connected sensor. |







[MENU/ESC] : Back ▲▼ : Scroll

Use the cursorpad (▲ or ▼) to scroll the screen to see the hidden information.

Press the **MENU/ESC** key to close the detailed information screen.

All alerts are rectified, the base screen appears.

1.4.3 Alert icons and their meanings

| Icon | Alert state | Visual Indication | Audible alert |
|---|--|-------------------------|--|
| Alert priority: Warning (Legacy mode only) | | | |
|  | Not acknowledged/ Not rectified | Yellow-orange, flashing | 2 short, audible alerts repeated every 60 seconds. |
|  | Not acknowledged/ Not rectified, Buzzer temporarily silenced | Yellow-orange, flashing | Silent |
|  | Acknowledged/ Not rectified | Yellow-orange | Silent |
|  | Not acknowledged/ Rectified | Yellow-orange, flashing | Silent |
| Alert priority: Caution | | | |
|  | Caution | Yellow | Silent |
| Alert priority: Indication (BAM mode only) | | | |
|  | Indication | Yellow | Silent |

1.5 How to Release the Fixed DRU

To release the Fixed DRU from its bracket (cradle), do the following:

1. Turn off the BATTERY and AC switches in that order to turn off the DCU power.
2. Remove the release pin.
3. Lift the release lever.
4. Lift the handle to separate the top of the DRU from the bottom of the DRU.
5. Cut the cable connected between the top and bottom of the DRU.

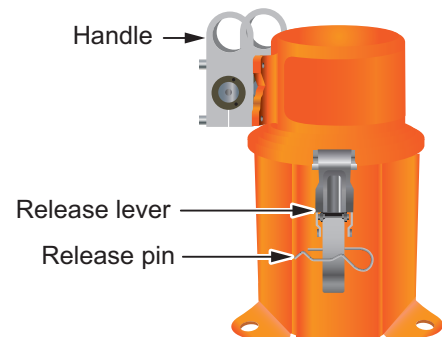

1.6 How to Release the Capsule from the Bracket of the Float-free DRU in Emergency Situation

In an emergency situation, release the capsule from the bracket of the Float-free DRU to remove the capsule if possible.

Note 1: The following instructions are written based on the Jotron Tron 40VDR/Tron 40VDR AIS instructions. For detailed information regarding the Jotron Tron 40VDR/Tron 40VDR AIS, see the user manual supplied with the VR-7021F/7024F.

Note 2: Do not drop the capsule from a high place.

Note 3: Do not release the capsule other than in an emergency situation or maintenance. The silicone grease is applied to the bottom of the capsule to prevent water

1. OPERATION

and foreign materials from entering into the gap between the capsule and bracket. After you release the capsule, apply the specified silicone grease (type:100946, code no.: 001-365-040) to the capsule before reattaching it (see page 2-3).

1. Release the safety clip and remove the cover of the bracket.

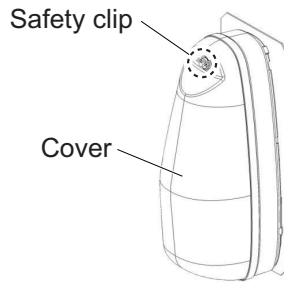

2. Grasp the antenna of the capsule, then pull out it.

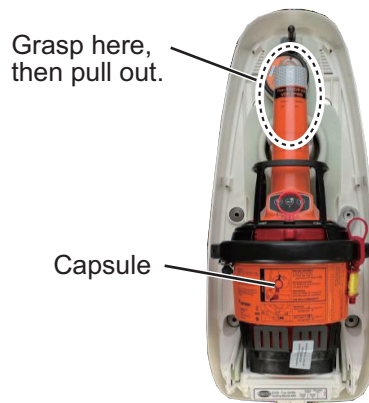

3. Put the capsule in an emergency bag and take it to a life raft.

Note: The wrist strap may be equipped to the capsule, depending on the time of manufacture. The capsule can be carried by using the provided wrist strap, where it is necessary to have both arms free, e.g. when climbing a ladder. The wrist strap can be pulled out of the pocket and your arm can be placed through it. It is not possible to put the wrist strap back into the pocket after usage.



4. If there is a satellite EPIRB on the life raft (excluding the capsule of the Float-free DRU), tie its towing rope to the life raft and float it on the sea. The satellite EPIRB activates and flashes its strobe light every three seconds. The satellite EPIRB operates for at least 48 hours, and the satellite EPIRB transmits the following signals.

- 406 MHz signal for distress every 50 seconds to a polar orbit satellite
- Locating signal to a stationary satellite
- 121.5 MHz signal for homing

Note: It is not required to activate the capsule of the Float-free DRU when the satellite EPIRB is in operation.

5. When the satellite EPIRB has stopped its operation or there is not a satellite EPIRB on a life raft, tie the towing rope of the capsule of the Float-free DRU to the life raft and float the capsule on the sea.
The capsule of the Float-free DRU activates and transmits 406 MHz signal for locating the position of the capsule, 121.5 MHz signal for homing and AIS messages (VR-7024F only) for at least 168 hours.
6. Upon completion of the rescue operations, pass the capsule to the rescue team for analysis of the data in the capsule.

After picking up the capsule

After picking up the capsule from the sea, dry it with a towel. When the capsule is dried, its strobe light stops flashing. Pass the capsule to the investigating authorities through the search and rescue team. The investigating authorities extract and analyze the data in the capsule.

Disposal of the capsule



The capsule must be discarded properly after extracting and analyzing the data. Vertically separate the capsule. For the bottom of the capsule, cut the battery's lead wires and wrap the vinyl tape around the wires to insulate them. For the upper part of the capsule dispose of the electronic parts according to local regulations for the disposal of industrial waste.

1. OPERATION

This page is intentionally left blank.

2. MAINTENANCE

Regular maintenance is important to maintain performance. This chapter contains maintenance instructions to be followed to obtain optimum performance and the longest possible life of the equipment.

|  WARNING | NOTICE |
|---|--|
|  ELECTRICAL SHOCK HAZARD Do not open the DCU cover. Only qualified personnel should work inside the equipment. | Do not apply paint, anti-corrosive sealant or contact spray to coating or plastic parts of the equipment. |
|  Do not disassemble or modify the equipment. Fire, electrical shock or serious injury can result. | Those items contain organic solvents that can damage coating and plastic parts, especially plastic connectors. |

2.1 General Maintenance and Cleaning

Dirt or dust may be removed from units with a soft cloth. Fresh water-moistened cloth may be used to remove stubborn dirt. DO NOT use any commercial cleaning agents to clean any unit. They can remove paint and markings.

Remote Alarm Panel VR-7017: Wipe the LCD of VR-7017 carefully to prevent scratching, using tissue paper and an LCD cleaner. To remove dirt or salt deposits, use an LCD cleaner, wiping slowly with tissue paper so as to dissolve the dirt or salt. Change paper frequently so the salt or dirt will not scratch the LCD. Do not use solvents such as thinner, acetone or benzene for cleaning. Also, do not use degreaser or anti-fog solution, as they can strip the coating from the LCD.

Waterproof Microphone VR-7012W: The watertight integrity of the microphone will be compromised if water contacts the ventilation sheet behind the MIC cover.

Fixed DRU VR-7021: Check the adhesive (silicone sealant) on the mounting bolt, nut and cable gland to confirm that the adhesive is not deteriorated, every three to six months. When deteriorated, reapply the adhesive. If severely deteriorated, remove all adhesive before reapplying. Deteriorated adhesive may cause water leakage or electrolytic corrosion.

2.2 Maintenance of the Float-free DRU

The capsule of the Float-free DRU transmits the signal similar to the distress signal of a satellite EPIRB. Therefore, trouble to the search and rescue authorities may occur if the capsule accidentally transmits the signal. If accidental transmission occurs, stop the transmission and inform the search and rescue authorities of the accidental transmission.

| Contact information | |
|--|--|
| A (cellular) telephone is usable in Japanese coastal waters. | 118 or 03-3591-9000 (Japan Coast Guard) |
| You can contact with the coast guard using the marine VHF band (within 25 miles from the coast). | Use the radio telephone of VHF channel 16 to contact the coast guard. |
| You can contact with the coast guard using the radio telephone of MF 2182 kHz (within 150 miles from the coast). | Use the radio telephone of MF 2182 kHz to contact the coast guard. |
| A satellite radio telephone like a Inmarsat is usable. | <ul style="list-style-type: none"> • Contact with the search and rescue authorities in each flag state. • For Japanese-flagged vessel, contact Japan Coast Guard at 81-3-35919000. |
| Things to inform | |
| Ship's name, call sign, MMSI, time, location, fact of the accidental transmission and own contact information. | |

2.2.1 Notice for the maintenance and self test

Do the maintenance and self test every month, keeping in mind the following points:

- Attach the cover to the bracket correctly after the maintenance, referring to "How to attach the cover" on page 5. If the cover is not attached correctly, the cover and capsule may drop out of the bracket due to wind and/or vibration.
- There are two electrodes at the back of the capsule (see right figure). If these electrodes are shorted by water with the capsule released from the bracket, the capsule may transmit the signal accidentally. Therefore, do not wash the capsule with water or release the capsule in rain and rough seas. When the capsule is seated in the bracket correctly, the electrodes are invalid. So, the capsule does not transmit the signal if the capsule get splashed with water.
- You can do the self test with the capsule seated in the bracket. However, the capsule can not transmit the test signal and test result may be "NG" when the bracket is fastened to a steel plate. In this case, release the capsule from the bracket and do the self test again.

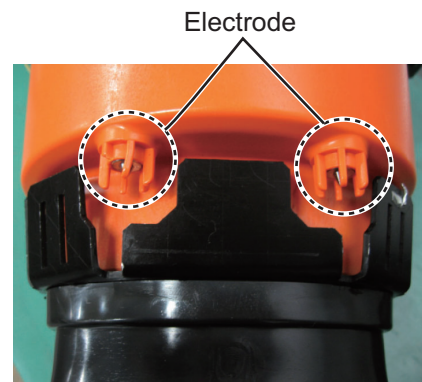

Note: Silicone grease is applied to the bottom of the capsule (see the next page). When you release the capsule during the self test, hold the capsule by its handle to prevent foreign material from contacting the grease. If foreign material contacts the grease, wipe off the grease, then reapply the specified silicone grease (type:100946, code no.: 001-365-040).

- The capsule transmits 406 MHz test signal. This signal does not initiate search and rescue operations because the satellites recognize it as a test signal. However, do not do the self test more than necessary.
- The capsule transmits 121.5 MHz homing signal in the self test. Aircrafts receive this homing signal. Do the self test five minutes every hour on the hour because the homing signal is recognized as a test signal during this time period.
- For VR-7024F, the capsule transmits the AIS messages in the self test. Normally, the AIS message transmitted in the self test are not displayed on the AIS receiver.
- You can maintain the Float-free DRU and do the self test with the VDR powered. However, the capsule should be returned to the bracket within 10 minutes after its release. The data buffer of the VDR can retain the data of the latest 10 minutes. If more than 10 minutes passes after releasing the capsule, the data of 10 minutes before the capsule is returned to the bracket is lost. At this time, the communication error with the Float-free DRU appears on the remote alarm panel. Finish any maintenance and diagnosis as quickly as possible to be prepared in case of an unexpected emergency and prevent loss of data.
- Apply the appropriate silicone grease between the docking module and storage module before reattaching the capsule, to prevent water and foreign materials from entering into the gap between the docking module and storage module. If foreign material contacts the modules, electrostatic capacity may change, preventing recording of data.

Note: Silicone grease is stored around the DCU after installing the Float-free DRU. Use the tube labeled "Silicone Grease for Tron 40VDR". Use only the specified silicone grease (type: 100946, code no.: 001-365-040). If the silicone grease is empty or lost, contact your dealer.

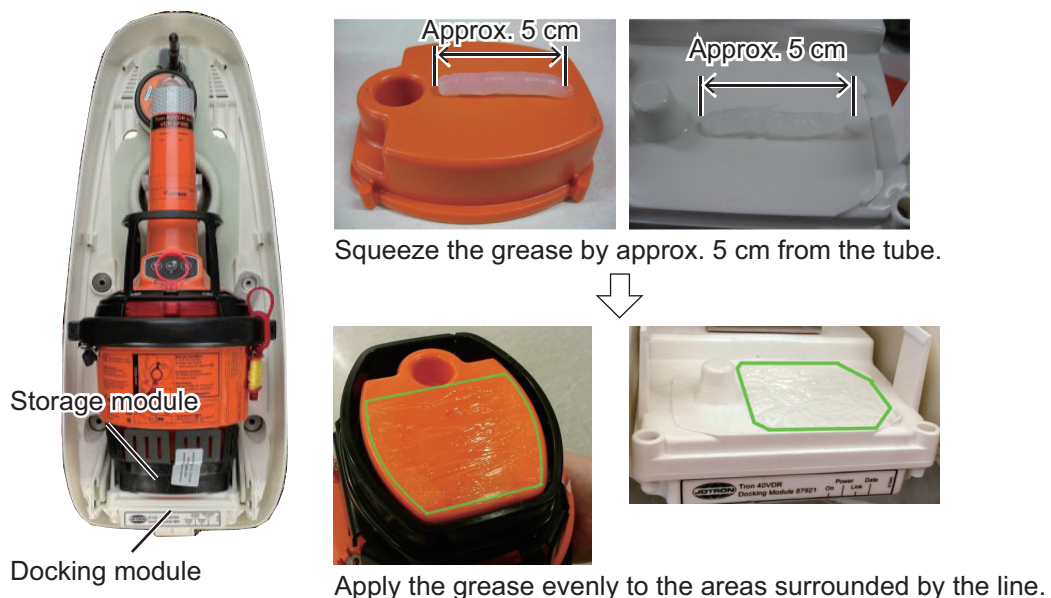

2. MAINTENANCE

- Do not use force to reattach the capsule and bracket cover. Also, confirm that there is no space or foreign material between the storage module and docking module (see figure below). If the capsule is not seated in the bracket correctly, the communication error occurs on the remote alarm panel after 10 minutes and the capsule may transmit the signal because that the electrodes are shorted by water.

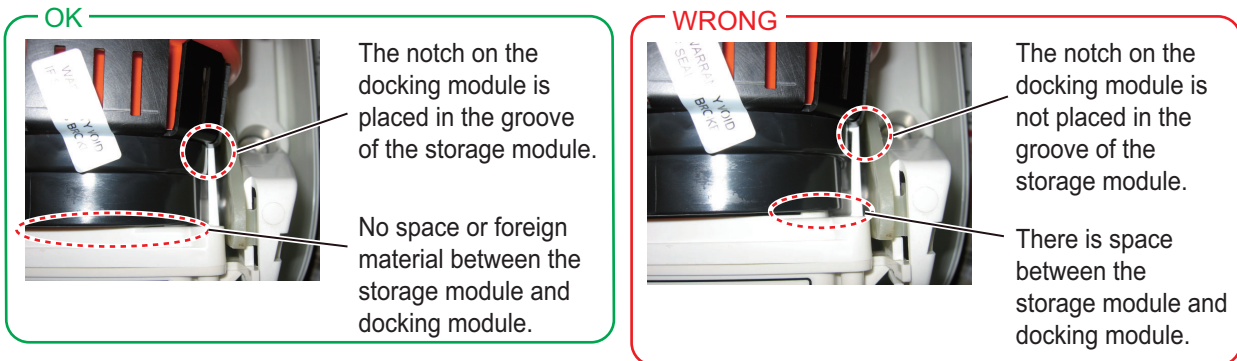

- Confirm that the error related to the Float-free DRU does not occur after the maintenance.
- The strobe light flashes at three second intervals when the capsule is transmitting the signal. If, during maintenance, the signal is accidentally transmitted, dry the electrodes of the capsule with a towel, then return it to the bracket. If the signal is still being transmitted, take the capsule to a steel cabin. Then, inform the search and rescue authorities of the accidental transmission.

Note: The Float-free DRU does not have a power switch. If the strobe light continues flashing in spite of the above measures, remove the internal battery from the capsule.

2.2.2 Monthly maintenance

Check the following points in the monthly maintenance.

| Maintenance point | Result |
|---|--------|
| Around the bracket | |
| Confirm that there is no object or structure which can interrupt the release of the capsule. | |
| Confirm that the cable connected to the bracket is fixed correctly. | |
| Confirm that the bracket is fixed to the mounting location and fixing bolts are fastened firmly. | |
| Appearance of the bracket | |
| Confirm that the bracket is not damaged and the characters inscribed on the bracket are readable. | |
| Confirm that no paint is applied to the bracket. | |
| Inside the bracket | |
| Confirm that water has not entered into the bracket. | |
| Confirm that there is no damage to the capsule, and all external parts (stickers, etc.) are in place. | |
| The expiration date for the battery and hydrostatic release unit is as follows: <ul style="list-style-type: none"> Battery: Five years (from date of coding or replacement) Hydrostatic release unit: Two years (from date of coding or replacement) The expiration date is indicated on the sticker attached to the capsule and hydrostatic release unit. Confirm that the expiration date has not passed. | |

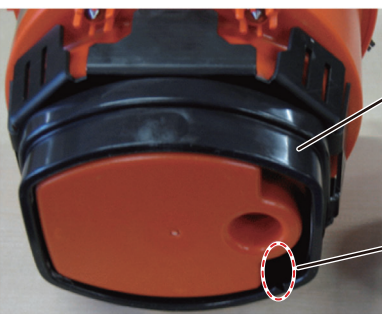
| Maintenance point | Result |
|---|--------|
| Inside the bracket | |
| <p>Confirm that the stopper at the bottom of the capsule is not damaged, and there is no crack on the groove.</p> <p>The stopper secures the battery case and storage module to the capsule. There is a groove on the stopper. When replacing the battery, cut the groove to remove the battery case. If the stopper is damaged or there is a crack on the groove, the stopper may not secure the battery case and storage module firmly. Contact your dealer to replace the stopper.</p>  | |
| Around the data transmitter | |
| <p>Confirm that there is no foreign materials between the storage module and docking module.</p> | |
| <p>Confirm that the silicone grease is applied to the gap between the storage module and docking module.</p> | |
| After reattaching the capsule | |
| <p>Confirm that the capsule is seated in the bracket correctly and there is no space between the storage module and docking module.</p> | |
| <p>Confirm that the bracket cover and safety clip are attached.</p> | |
| Alert | |
| <p>Confirm that the communication error with the Float-free DRU does not appear on the remote alarm panel. This alert appears when the VDR can not record the data to the capsule for 10 minutes. Seat the capsule to the bracket correctly to rectify the alert.</p> | |

How to attach the cover

Attach the cover to the bracket as follows after the maintenance. If the cover is not attached correctly, the cover and capsule may drop out of the bracket due to wind and/or vibration.

1. Fit the notch on the cover with the ridge on the bracket.

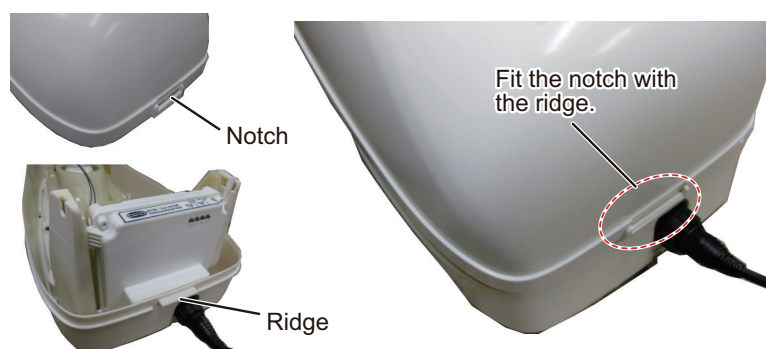

2. MAINTENANCE

2. There is a groove alongside the cover that has to be aligned and fit around the tongue on the bracket. Align the tongue on the bracket and groove alongside the cover.

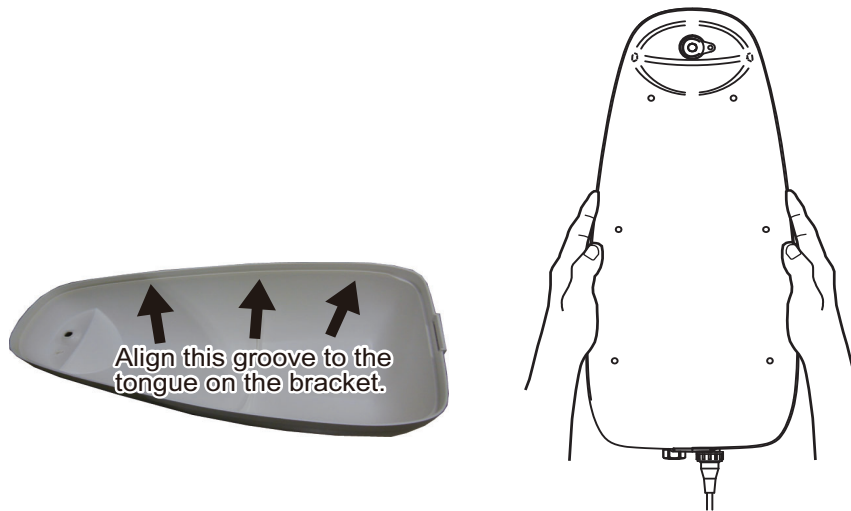

3. Attach the cap to the hole at the top of the cover, then insert the safety clip.
Note: Make sure the safety clip is mounted correctly, referring to the following figure.

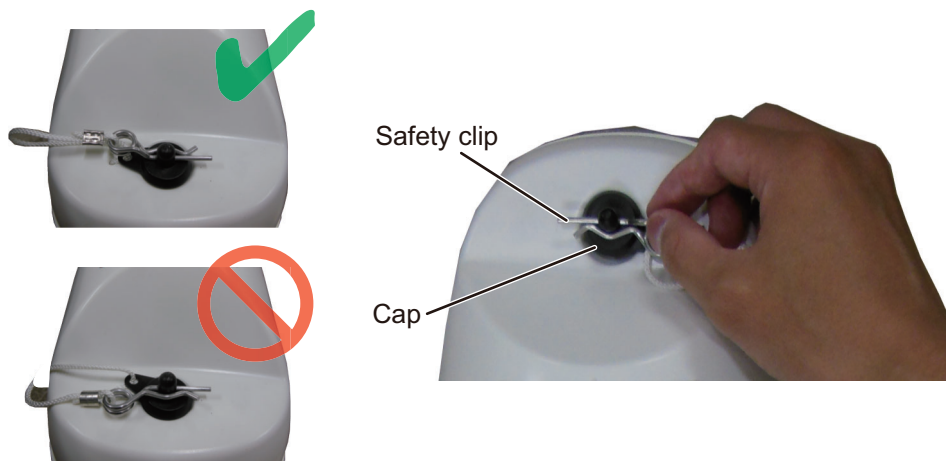

2.2.3 Normal self test

The normal self test transmits a test signal on all frequencies (121.5 MHz, AIS (VR-7024F only) and 406 MHz), to check that the main functionality of the EPIRB works properly. These test signals are not recognized as distress signals. While transmitting the test signals, the battery and the transmitted signals are tested.

Note: Hold the capsule by its handle during the test. This keeps foreign material away from the silicone grease on the capsule, and keeps the antenna of the capsule away from metallic objects or human body.





Self test procedure for the VR-7024F

1. Remove the capsule from the bracket.
2. Move the switch to the test position and hold until the test indicator lights.



Test sequence

- 1) The test indicator goes off briefly every time a signal is transmitted.
- 2) If the RLS protocol is enabled, the blue RLS indicator will light for approximately 1 second.
- 3) The strobe light will flash once if the self test is successful. If the self test detects a fault in the EPIRB module, the test indicator will start flashing at the end of the test.

|  |  |  |  |  |
|---|---|---|--|---|
| Test sequence | Position indicator | RLS indicator | Test indicator | Strobe light |
| Self-test started | - | - | ○ On | - |
| Signals transmitted | - | - | ●●●● Multiple short off periods | - |
| RLS enabled * | - | ● On for 1 second | - | - |
| Self test successful | - | - | - | ○ One flash |
| If one of the above tests are unsuccessful, the remaining test sequences will not be performed, and the test indicator will indicate self-test failure. | | | | |
| Self-test failure | | | ○○○ Multiple flashes** | |

*: For EPIRBs with RLS disabled, the RLS indicator will remain off.

** : See "Test failure indications" below.

Test failure indications

If one of the sequences in the extended or normal self test is unsuccessful, the test indicator will flash a number of times according to the table below to indicate the occurred failure. For details of each failure, see the Jotron's manual.

|  | Failure indication |
|---|--|
| Number of flashes | |
| 2 | Battery failure |
| 3 | Transmitter failure |
| 4 | - |
| 5 | No position |
| 6 | - |
| 7 | Maximum number of extended self-tests exceeded |
| 8 | - |
| 9 | - |
| 10 | Wrong programming |

3. When the result of the test is not "OK", change the location and retry the self test. If not resolved, contact your dealer.

2. MAINTENANCE

4. Check if there is sufficient silicone grease at the bottom of the capsule and that the grease is free of foreign material. If there is no grease or the grease contains foreign material, wipe off the grease and then reapply the specified silicone grease (type:100946, code no.: 001-365-040).

Self test procedure for the VR-7021F

1. Remove the capsule from the bracket.
2. Push and hold the lever in "TEST" position for 15 seconds.

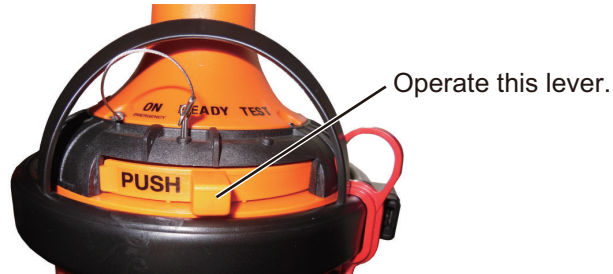

3. The strobe light flashes once if operation is normal. Multiple flashes indicate error. See the table below for number of flashes and error.

| Number of flashes | Result |
|-------------------|---|
| 1 | OK. |
| 2 | Low power on 406 MHz transmitter. |
| 3 | Low battery voltage. |
| 4 | Low power on 121.5 MHz transmitter. |
| 5 | Frequency error on 406 MHz transmitter. |
| 6 | Frequency error on 121.5 MHz transmitter. |
| 7 | EPIRB module is not programmed or programming is not completed. |

4. When the result of the self test is not "OK", change the location and retry the self test. If not resolved, contact your dealer.
5. Release the lever and set it to the "READY" position. Check if there is sufficient silicone grease at the bottom of the capsule and that the grease is free of foreign material. If there is no grease or the grease contains foreign material, wipe off the grease and then reapply the specified silicone grease (type:100946, code no.: 001-365-040).

2.2.4 Extended self test

The extended self test includes a GNSS test in addition to the normal self test.

Note 1: The extended self test reduces the lifetime of the battery. Therefore, do this test once every three months.

Note 2: The extended self test can only be performed 60 times. If you perform the self test more than 60 times, the self test result indicates "Maximum number of extended self tests exceeded".

Extended self test procedure for VR-7024F

To perform the extended self test, do the following steps within a period of 3 seconds:



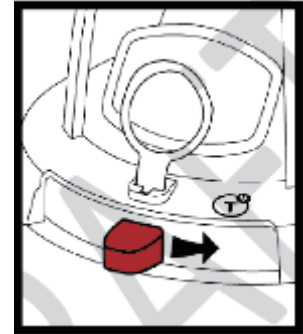

1. Remove the capsule from the bracket.
2. Move the switch to the test position.
3. Release to middle position.
4. Move the switch to the test position and release it when the white test indicator lights up.



Test sequence

The white test indicator LED will light up and the green GNSS indicator LED will start flashing in sequences of 3 fast flashes. This indicates that the EPIRB is searching for a valid position. When a valid position is found, the green GNSS indicator LED will remain lit for approximately 1 second and normal self test will continue.

The strobe light will flash once at the end of the test if the extended self test is successful. If the self test detects a fault in the EPIRB module, the test indicator LED will start flashing at the end of the test. For fault codes, see "Test failure indications" on page 2-7.

|  |  |  |  |  |
|---|--|--|---|--|
| Test sequence | Position indicator | RLS indicator | Test indicator | Strobe light |
| Extended self-test started | - | - | ○ On | - |
| Waiting for position | ●●●●● Triple flashes | - | - | - |
| Position achieved | ● On for 1 second | - | - | - |
| Self-test started | - | - | ○ On | - |
| Signals transmitted | - | - | ●●●●● Multiple short off periods | - |
| RLS enabled * | - | ● On for 1 second | - | - |
| Extended self-test successful | - | - | - | ○ One flash |
| If one of the above tests are unsuccessful, the remaining test sequences will not be performed, and the test indicator will indicate self-test failure. | | | | |
| Self-test failure | | | ○○○ Multiple flashes** | |

*: For EPIRBs with RLS disabled, the RLS indicator will remain off.

** : See "Test failure indications" on page 2-7.

5. When the result of the self test is not "OK", change the location and retry the self test. If not resolved, contact your dealer.
6. Release the lever and set it to the "READY" position. Check if there is sufficient silicone grease at the bottom of the capsule and that the grease is free of foreign material. If there is no grease or the grease contains foreign material, wipe off the

2. MAINTENANCE

grease and then reapply the specified silicone grease (type:100946, code no.: 001-365-040).

Extended self test procedure for VR-7021F

1. Remove the capsule from the bracket.
2. Move the lever to “TEST” position twice within 3 seconds and return it to “READY” position.
The GPS test starts and a short beep sounds every 3 seconds until GPS position is acquired. The GPS test may take up to 2 minutes.
3. Two beeps sound for normal operation. Multiple beeps sound for error, as shown in the table below.

| Number of beeps | Result |
|-----------------|--|
| 2 | OK. |
| 5 | GPS positioning error. |
| 10 | Number of GPS tests performed exceeds the limit. |

4. The normal self test is started after the GPS test. Confirm that the strobe light flashes once.
When the result of the self test is not “OK”, change the location and do the normal self test. If not resolved, contact your dealer.
5. Check that the grease at the bottom of the capsule is sufficient and free of foreign material. Reapply if necessary. Return the capsule to the bracket.

2.2.5 Annual Performance Test for the Float-free DRU

The Float-free DRU must undergo an annual performance test because it is a part of the VDR system. Annual performance test is defined in the regulation of SOLAS. For Japanese-flagged vessel, the radio inspection is required by the Ministry of Internal Affairs and Communications.

For foreign-flagged vessel

All units in the VDR system must undergo an annual performance test. This test is conducted by a test engineer authorized by the manufacturer and certified by a relevant ship classification society. The EPIRB performance test for the Float-free DRU is conducted by a engineer or service provider responsible for Jotron’s Tron40S MkII/ Tron40GPS/Tron40VDR AIS.

For Japanese-flagged vessel

For Japanese-flagged vessel, the radio inspection is required by the Ministry of Internal Affairs and Communications. This inspection is conducted by a engineer authorized by the Ministry of Internal Affairs and Communications, such as GMDSS service station of the Japan Ship-Machinery Quality Control Association. For the VDR annual performance test and Float-free DRU performance test is conducted by a engineer authorized by the Ship’s Electric Installation Contractors’ Association of Japan.

2.2.6 Shore-Based Maintenance (SBM)

The capsule of the Float-free DRU has the same functionality of an satellite EPIRB (Emergency Position-Indicating Radio Beacon). So, it is required to conduct the SBM in accordance with IMO guidelines at intervals specified by flag administration, within five years from installation or previous SBM. Also, the battery in the capsule must be

replaced during the SBM because the expiration date of the battery is five years from manufacture or replacement date. Ask a workshop responsible for the satellite EPIRB to conduct the SBM.

2.3 Annual Recertification

All units in the VDR system must undergo an annual performance test, in accordance with SOLAS regulations. This test is conducted by a test engineer authorized by the manufacturer and certified by a relevant ship classification society.

For foreign-flagged vessel

Contact a test engineer authorized by the manufacturer and certified by a relevant ship classification society for the VDR annual performance test.

For Japanese-flagged vessel

Contact a service station of the Japan Ship-Machinery Quality Control Association for the VDR annual performance test.

Remote analysis

- The remote analysis request window, as shown in the figure to the right, appears.
Note: While the request window is displayed, a beep sounds every 30 seconds.



[Yes]: Start the remote analysis. Go to step 2.

[Later]: The window for request of remote analysis appears again after 30 seconds. If OK, go to step 2.

[No]: Cancel the remote analysis. The message "Remote Analysis not performed" appears. Press any key to clear the window.

- Select [Yes] then press the **ENT** key. The remote analysis information window, as shown in the figure below, appears.

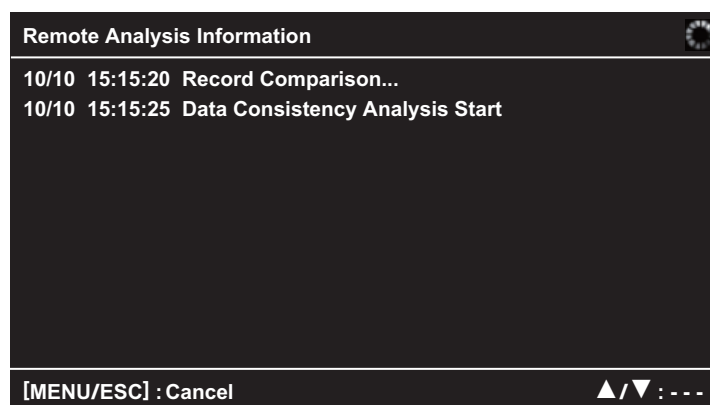

“Scroll” is displayed when the information is over the screen.

When you want to use the SAVE function, remote analysis must be cancelled first. Press the **MENU/ESC** key to cancel the remote analysis anytime. The message "Remote Analysis Cancel?" appears. Press the **ENT** key. The message "Remote Analysis Canceled" appears. Press any key to clear the window.

2. MAINTENANCE

- When the remote analysis finishes, the message "Remote Analysis Finished" appears. Press any key to clear the window.

2.4 Fuse Replacement

The DCU VR-7010, Video LAN Converter IF-7100 and Sensor Adapter MC-3000S have fuses that protect them from high electric current and equipment fault. If you cannot turn on the power to a unit, check its fuse to see if it has blown. If the fuses for the DCU have blown, replace them with the specified fuses (see page AP-3 for the fuse location). If the fuses blow again after replacement, contact a FURUNO agent or dealer. Have a qualified technician replace the fuse for Video LAN Converter and Sensor Adapter.

 **WARNING**

 **Use the correct fuse.**
A wrong fuse can cause fire or serious damage to the equipment.

| Unit | Name | Type | Code No. | Remarks |
|----------|-----------------|---------------------|----------------|--------------|
| VR-7010 | Glass Tube Fuse | FGBO-A 250V 10A PBF | 000-155-839-10 | For battery |
| | | | | For AC power |
| IF-7100 | Glass Tube Fuse | FGMB-A 125V 2A PBF | 000-157-479-10 | |
| MC-3000S | Glass Tube Fuse | FGMB-A 125V 3A PBF | 000-157-481-10 | |

2.5 Consumable Parts

You can check the lifetimes of the consumable parts on the RAP screen (see "[Life Parts List]" on page 1-11). Contact your dealer to replace the consumable parts.

| Unit | Name | Type | Interval | Indication on the RAP |
|----------|--------------------------|-------------|----------|-----------------------|
| VR-7010 | Battery | CY1-1487-01 | 4 years | "VR-7010 Battery" |
| VR-7020 | Acoustic Beacon | PT9 NINETY | 3 years | "VR-7020 Acoustic B" |
| VR-7021F | Battery | 89340 | 5 years | "VR-7021F Battery M" |
| VR-7024F | | | | "VR-7024F Battery M" |
| VR-7021F | Hydrostatic Release Unit | 86218 | 2 years | "VR-7021F HRU" |
| VR-7024F | | | | "VR-7024F HRU" |

Note: Dispose of the battery in accordance with local regulations.



WARNING

Battery handling precautions

- Do not attempt to disassemble the battery. If accidental skin/eye contact is made with the battery fluid, wash the affected area/part immediately with liberal amounts of clean fresh water and seek IMMEDIATE medical attention.
- DO NOT INCINERATE batteries as they are liable to rupture if placed into a fire. Batteries that have reached the end of their service life must be disposed of in accordance with appropriate regulations.
- Do not short battery terminals. Short can lead to bursting or fire.



CAUTION

Do not:

- use batteries of different capacities
- mix old batteries with new
- mix batteries of different makes

Batteries themselves may become damaged or damage to electrical parts may result.

2.6 Self Test

The self test checks the ROM, RAM, connection, program no., keyboard, LCD performance and buzzer. The user can do the tests to help the service technician in troubleshooting.

How to open the test menu

Press the **TEST** key on the RAP to show the test menu.

| |
|--------------------|
| Self Test |
| LCD Test |
| Buzzer Test |

Self test

1. Open the test menu.
2. Use the cursorpad (▲ or ▼) to select [Self Test] then press the **ENT** key.

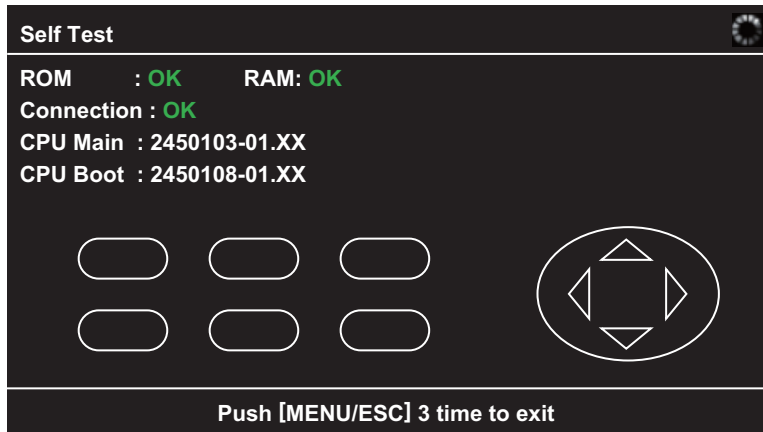

Note: The self test screen closes automatically when there is no menu operation for 60 seconds.

3. Press each key one by one. A key's corresponding location on the display is colored if the key is normal.
4. Press the **MENU** key three times to close the self test screen.

LCD test

1. Open the test menu.
2. Use the cursorpad (▲ or ▼) to select [LCD Test] then press the **ENT** key. Each press of the **ENT** key changes the LCD pattern in the sequence shown below.

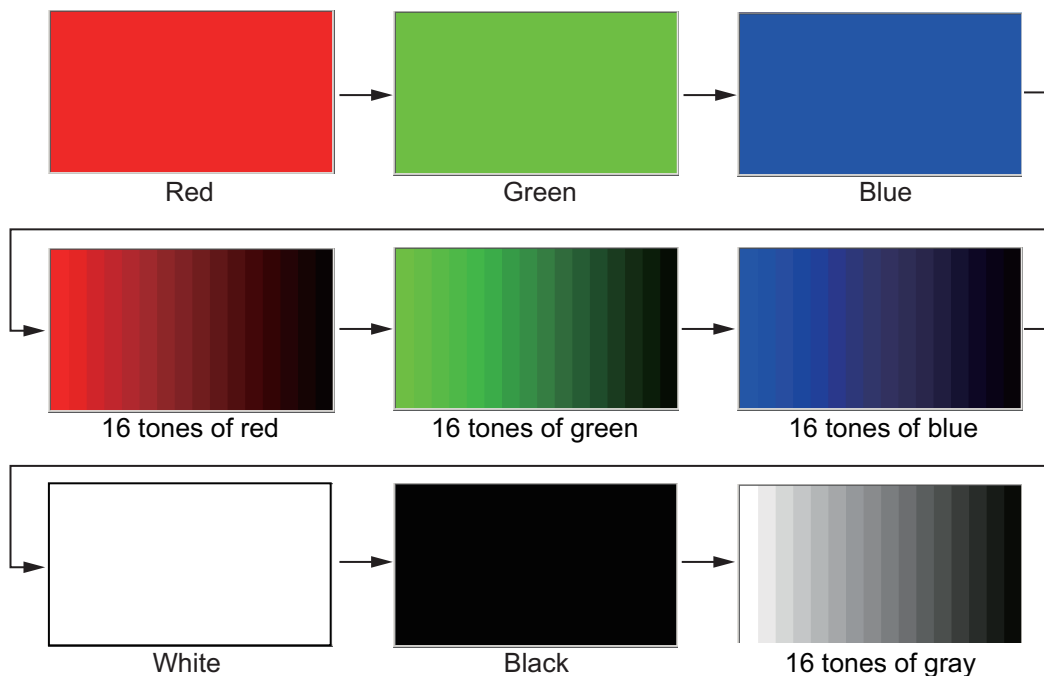

Note 1: The LCD test screen closes automatically when there is no menu operation for 60 seconds.

Note 2: You can cancel the test at any time by pressing the **MENU** key.

3. Press the **MENU** key to close the LCD test screen.

Buzzer test

1. Open the test menu.
2. Use the cursorpad (▲ or ▼) to select [Buzzer Test] then press the **ENT** key. The buzzer test window appears then a buzzer sounds for 60 seconds.

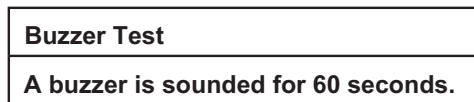

Note 1: The buzzer test window closes automatically when there is no menu operation for 60 seconds.

Note 2: You can cancel the test at any time by pressing any key.

2.7 Verification of Recording Function of the Long Term Device

Verify the long term device recording function at the annual inspection and when repairing or maintaining the VDR or sensors connected to the VDR. The verification requires the Live Player V5. Refer to its Operator's Manual for the operating procedure.

1. Start the Live Player V5 on the PC.
2. Connect the LAN cable between J502 port on the DCU and the PC.

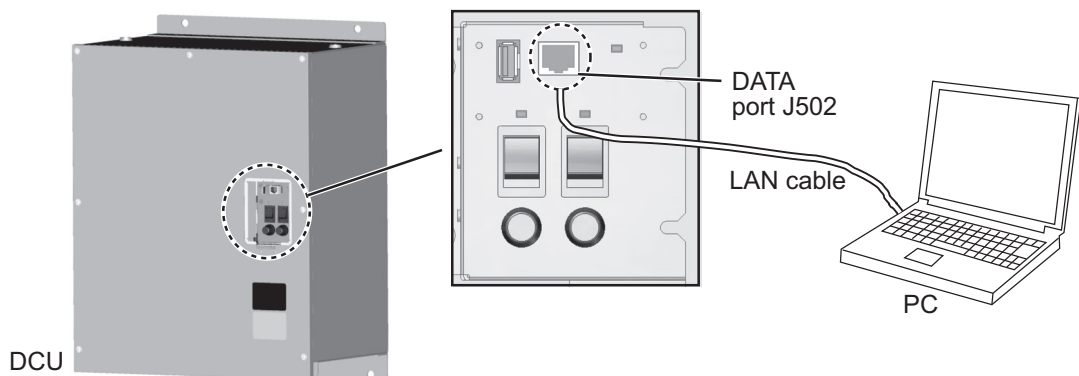

3. Open the [Tool] menu and select [Source Select].
4. Select [Long Term Device (LAN)] from the menu.
5. Click the [Analyze Track] button.
6. Click the [Connect] button.
7. Select [Extract] from the [Tool] menu to show the [Extraction] dialog box.
8. Activate the [Track Selection] radio button, then check the track you want to extract.
9. Click the [Select] button and select the location where to save data.
10. Click the [Start] button.
11. After the extraction* is completed, click [OK], [Close] and [Close] in that order. Then, disconnect the cable between the PC and J502 in the DCU.

*: The time required for the extraction depends on the VDR environment and specifications of the PC to be extracted. See the table below.

| Amount of extraction data | Time required for extraction | File size on the PC |
|---------------------------|------------------------------|---------------------|
| 1 hour | 1 to 2.5 minutes | 300 to 900 MB |
| 12 hours | 15 to 22 minutes | 3.5 to 8 GB |

2. MAINTENANCE

This page is intentionally left blank.

3. TROUBLESHOOTING

This chapter provides information on possible causes of problems you may experience with your VDR. If you still have a problem after referring to the table, contact your dealer for further advice. Always provide the product serial number.

3.1 General Troubleshooting

Use the table below to identify the problem, cause and remedy.

| Problem | Cause | Remedy |
|--------------------------------|--|--|
| AC LED does not light. | No power from the ship's mains. | Check the breaker switches on ship's mains switchboard. |
| BATTERY LED does not light. | The battery voltage is low or no power from the battery. | Contact your dealer. |
| BATTERY LED flashes. | During charging of the battery | Keep turning on the AC power until finishing the battery charge. The battery charge may takes approx. six hours. |
| SYSTEM FAIL LED lights in red. | System malfunction | The alert number for each alert appears in the alert list on the RAP. For each alert's remedy, see section 3.2. |

3.2 Alert List

3.2.1 Alert list for BAM mode

BAM mode alerts

This equipment provides aggregated header alerts for presentation of an aggregation on the AMS (Alert Management System). The following table shows the aggregate header alerts along with the corresponding alert number.

| Aggregated Alert Name | Alert No.* |
|-----------------------|------------|
| Lost Connection | 3003, x |
| Lost Sensor | 3016, x |
| Power fail | 3023, x |
| Audio Failure | 412218, x |
| Record Failure | 412511, x |

*: "x" indicates instance number.

The following table lists the possible alerts for this equipment.

Note: The alert IDs are based on IEC62923. Therefore, some alerts generate with the same alert ID. When you request service, report the alert ID and title.

3. TROUBLESHOOTING

| Alert ID, instance ID | Alert Title | Alert Message | Priority & Category |
|-----------------------|---|---|---------------------|
| 3003, 1 | Lost DCU (Lost RAP) | Restart the VDR. | Caution Cat: B |
| | <p>Meaning: Connection between DCU and RAP is lost. On the RAP, "Lost DCU" appears.</p> <p>Remedy: Check the connection with RAP, then restart the VDR. To restart the VDR, open the DCU door with its key and turn on the AC and BATTERY switches on the power control panel, then turn the switches on after shutdown of the DCU.</p> | | |
| 3003, 2 to 3003, 17 | Lost Serial Ch xx (xx: 01 - 16) | Check Ch xx connected sensor. (xx: 01 - 16) | Caution Cat: B |
| | <p>Meaning: No. xx serial channel has not received correct format data from a connected serial device (xx: 01 - 16).</p> <p>Remedy: Check the sentences input from the serial channel on the RAP and confirm that the applicable sensor is operating correctly.</p> | | |
| 3003, 18 to 3003, 81 | Lost LAN Ch xx (xx: 01 - 64) | Check Ch xx LAN connected sensor. (xx: 01 - 64) | Caution Cat: B |
| | <p>Meaning: No. xx sensor (LAN) channel has not received correct format data from a connected sensor (LAN) device (xx: 01 - 64).</p> <p>Remedy: Check the sentences input from the LAN channel on the RAP and confirm that the applicable sensor is operating correctly.</p> | | |
| 3016, 1 | Lost GPS | Check the GPS receiver. And restart VDR. | Caution Cat: B |
| | <p>Meaning: System has not received UTC information.</p> <p>Remedy: Check that a valid UTC source (GPS receiver) is connected to the serial port, then restart the VDR. To restart the VDR, open the DCU door with its key and turn on the AC and BATTERY switches on the power control panel, then turn the switches on after shutdown of the DCU.</p> | | |
| 3016, 2 to 3016, 5 | Lost Radar Image x (x: 1 - 4) | Turn on the No.x Radar. And restart VDR. (x: 1 - 4) | Caution Cat: B |
| | <p>Meaning: No.x Radar has been powered off and the image data is not received (x: 1 - 4).</p> <p>Remedy: Turn on the No. x Radar (x: 1 - 4), then restart the VDR. To restart the VDR, open the DCU door with its key and turn on the AC and BATTERY switches on the power control panel, then turn the switches on after shutdown of the DCU.</p> | | |
| 3016, 6 to 3016, 8 | Lost ECDIS Image x (x: 1 - 3) | Turn on the No.x ECDIS. And restart VDR. (x: 1 - 3) | Caution Cat: B |
| | <p>Meaning: No.x ECDIS has been powered off and the image data is not received (x: 1 - 3).</p> <p>Remedy: Turn on the No. x ECDIS (x: 1 - 3), then restart the VDR. To restart the VDR, open the DCU door with its key and turn on the AC and BATTERY switches on the power control panel, then turn the switches on after shutdown of the DCU.</p> | | |
| 3023, 1 | AC fail | Reconnect AC power. | Caution Cat: B |
| | <p>Meaning: AC power is down and the battery is running.</p> <p>Remedy: Reconnect AC power.</p> | | |
| 3023, 2 | Battery fail | Confirm that the battery switch is on. | Caution Cat: B |
| | <p>Meaning: No battery input or voltage is too low.</p> <p>Remedy: Confirm that the battery switch is turned on. If ON, recharge or replace the battery.</p> | | |

| Alert ID, instance ID | Alert Title | Alert Message | Priority & Category |
|-----------------------|---|----------------------|---------------------|
| 412218, 1 | Fail MIC Test | Contact your dealer. | Caution Cat: B |
| | <p>Meaning: This alert is issued when the microphone test fails. The microphone test is run every 12 hours during normal operation.</p> <p>Remedy: Contact your dealer to check the equipment.</p> | | |
| 412218, 2 | Lost Audio IF | Restart the VDR. | Caution Cat: B |
| | <p>Meaning: Audio IF Board has been disconnected more than 60 seconds.</p> <p>Remedy: Check the connection with the Audio IF Board, then restart the VDR. To restart the VDR, open the DCU door with its key and turn on the AC and BATTERY switches on the power control panel, then turn the switches on after shutdown of the DCU.</p> | | |
| 412511, 1 | Rec Fail Fixed DRU | Restart VDR. | Caution Cat: B |
| | <p>Meaning: Fixed DRU is unable to write.</p> <p>Remedy: Check the connection with the Fixed DRU, then restart the VDR. To restart the VDR, open the DCU door with its key and turn on the AC and BATTERY switches on the power control panel, then turn the switches on after shutdown of the DCU.</p> | | |
| 412511, 2 | Rec Fail Float DRU | Restart VDR. | Caution Cat: B |
| | <p>Meaning: Float-free DRU is unable to write.</p> <p>Remedy: Check that the capsule is seated in the bracket correctly, then restart the VDR. To restart the VDR, open the DCU door with its key and turn on the AC and BATTERY switches on the power control panel, then turn the switches on after shutdown of the DCU.</p> | | |
| 412511, 3 | Rec Fail Long Term | Restart VDR. | Caution Cat: B |
| | <p>Meaning: Long Term Device is unable to write.</p> <p>Remedy: Restart the VDR. To restart the VDR, open the DCU door with its key and turn on the AC and BATTERY switches on the power control panel, then turn the switches on after shutdown of the DCU. If the error re-occurs, contact your dealer.</p> | | |
| 412511, 4 | Record Stop | Restart VDR. | Caution Cat: B |
| | <p>Meaning: Inside temperature of DCU is very high, and VDR stopped recording.</p> <p>Remedy: Restart the VDR. To restart the VDR, open the DCU door with its key and turn on the AC and BATTERY switches on the power control panel, then turn the switches on after shutdown of the DCU. If the error re-occurs, contact your dealer.</p> | | |

3. TROUBLESHOOTING

BAM mode indications

The following indications are shown in the BAM mode. The indications have no category and priority, are not output as ALF sentences.

Note: Indications also appear on the alert list.

| ID | Title | Description | Action |
|-----------|---|---|---|
| 412026, 1 | GPS Large Time Difference | This indicates that the time difference between the system time of the DCU and the UTC time supplied by a GPS receiver is more than 10 seconds. | Restart the DCU with the GPS receiver connected. To restart the VDR, open the DCU door with its key and turn on the AC and BATTERY switches on the power control panel, then turn the switches on after shutdown of the DCU. If the error re-occurs, contact your dealer. |
| 412083, 1 | No AMS1 Connection | AMS1 is missing. Connection to AMS1 is lost. | Check cable connected to AMS1. Reconnect AMS1. |
| 412085, 1 | No AMS2 Connection | AMS2 is missing. Connection to AMS2 is lost. | Check cable connected to AMS2. Reconnect AMS2. |
| 412088, 1 | No JB Connection | Indicates that Junction Box (IF-8530) is missing. | Check cable connected to Junction Box. Reconnect Junction Box. If the error re-occurs, contact your dealer. |
| 412170, 1 | VDR Configuration Failure | Data cannot be stored because of abnormal VDR configuration. | Restore VDR config data. If the error re-occurs, contact your dealer. |
| 412171, 1 | Recording Buffer Overflow | A image exceeding a recording buffer is input. | Contact your dealer. |
| 412173, 1 | Fatal System Failure | Fatal system error. Reboot automatically after an error occurred. | If the error re-occurs, contact your dealer. |
| 412175, 1 | LongTermDevice is stopped from recovering | The data cannot be recorded to the long term device more than ten minutes. | Restart VDR. To restart the VDR, open the DCU door with its key and turn on the AC and BATTERY switches on the power control panel, then turn the switches on after shutdown of the DCU. If the error re-occurs, contact your dealer. |
| 412176, 1 | FixedDRU is stopped from recovering | The data cannot be recorded to the Fixed DRU more than ten minutes. | |
| 412177, 1 | FloatDRU is stopped from recovering | The data cannot be recorded to the Float-free DRU more than ten minutes. | Confirm that the capsule is seated in the bracket correctly, then restart VDR. To restart the VDR, open the DCU door with its key and turn on the AC and BATTERY switches on the power control panel, then turn the switches on after shutdown of the DCU. If the error re-occurs, contact your dealer. |

| ID | Title | Description | Action |
|-----------|---|---|---|
| 412181, 1 | FixedDRU Setting Defect | Fixed DRU information is read, even though settings are not complete. | Contact your dealer. |
| 412182, 1 | FloatDRU Setting Defect | Float DRU information is read, even though settings are not complete. | |
| 412185, 1 | SAVE Setting Difference | SAVE function settings differ between VDR and RAP. | Confirm VDR and RAP settings. |
| 412186, | RAP Version is old | RAP/mod.tgz program version is not compatible with the DCU program version. | Contact your dealer. |
| 412187, | Module Version is old | | |
| 412246, | PDU Failure | The cable between PDU and CPU block is not connected. | Contact your dealer. |
| 412254, 1 | Self Test Failure | System failed by the self test. | |
| 412431, 1 | Serial Buffer Overflow | Serial data from DCU serial channel (1 - 8 ch) are not recorded to Fixed DRU, Float-free DRU and Long Term Device. | |
| 412432, 1 | JB Buffer Overflow | Serial, analog and digital data from Junction Box (IF-8530) are not recorded to Fixed DRU, Float-free DRU and Long Term Device. | Restart VDR. To restart the VDR, open the DCU door with its key and turn on the AC and BATTERY switches on the power control panel, then turn the switches on after shutdown of the DCU. If the error re-occurs, contact your dealer. |
| 412437, 1 | Fatal System Failure | Fatal system error. This indicates that VDR can not be rebooted automatically. | |
| 412438, 1 | System Information Error (VDR System Information Error) | VDR system information can not be acquired. Usually, this error is recovered automatically. | |
| 412451, 1 | High CPU Core Temperature | Temperature of CPU core is high. | Restart VDR. To restart the VDR, open the DCU door with its key and turn on the AC and BATTERY switches on the power control panel, then turn the switches on after shutdown of the DCU. If the error re-occurs, contact your dealer. |
| 412452, 1 | High CPU System Temperature (CPU Board System Temperature High) | Temperature of CPU board is high. | |
| 412453, 1 | CPU +3.3V Voltage Error (CPU Board +3.3V Voltage Error) | Voltage error on CPU board. (+3.3 V line) | |
| 412454, 1 | CPU +5V Voltage Error (CPU Board +5V Voltage Error) | Voltage error on CPU board. (+5 V line) | |
| 412455, 1 | CPU +12V Voltage Error (CPU Board +12V Voltage Error) | Voltage error on CPU board. (+12 V line) | |

3. TROUBLESHOOTING

| ID | Title | Description | Action |
|-----------|---|--|---|
| 412456, 1 | CPU VCORE Voltage Error (CPU Board VCORE Voltage Error) | Voltage error on CPU board. (VCORE line) | Restart VDR. To restart the VDR, open the DCU door with its key and turn on the AC and BATTERY switches on the power control panel, then turn the switches on after shutdown of the DCU. If the error re-occurs, contact your dealer. |
| 412457, 1 | Low CPU Battery Voltage (CPU Board Battery Voltage Lower) | Voltage of battery on CPU board is low. | |
| 412458, 1 | Low CPU FAN Rotation Speed | Rotation speed of CPU FAN is low. | |
| 412459, 1 | CPU FAN Not Rotated | CPU FAN stopped. | |
| 412460, 1 | Low External FAN1 Rotation Speed | Rotation speed of external FAN1 is low. | |
| 412461, 1 | External FAN1 Not Rotated | External FAN1 stopped. | |
| 412462, 1 | Low External FAN2 Rotation Speed | Rotation speed of external FAN2 is low. | |
| 412463, 1 | External FAN2 Not Rotated | External FAN2 stopped. | |
| 412501, 1 | No FixedDRU Connection | Fixed DRU has been disconnected more than 600 seconds. | Check the connection with the Fixed DRU. If OK, contact your dealer. |
| 412502, 1 | No FloatDRU Connection | Float-free DRU has been disconnected more than 600 seconds. | Check that the capsule is seated in the bracket correctly. If OK, contact your dealer. |
| 412503, 1 | No LongTermDevice Connection | Long Term Device has been disconnected more than 600 seconds. | Contact your dealer. |
| 412504, 1 | No UserDisk Connection | UserDisk has been disconnected more than 600 seconds. | |
| 412514, 1 | UserDisk Recording Failure | UserDisk is unable to write. | Restart the VDR. To restart the VDR, open the DCU door with its key and turn on the AC and BATTERY switches on the power control panel, then turn the switches on after shutdown of the DCU. |
| 412515, 1 | FixedDRU Exchanged | Fixed DRU is replaced. | |
| 412516, 1 | FloatDRU Exchanged | Float-free DRU is replaced. | |
| 412517, 1 | LongTermDevice Exchanged | Long Term Device is replaced. | |
| 412518, 1 | No.1 LongTermDevice Error | No.1 Long Term Device is error. | |
| 412519, 1 | No.2 LongTermDevice Error | No.2 Long Term Device is error. | |
| 412521, 1 | FixedDRU Memory Shortage | Data cannot be recorded more than 48 hours. | |
| 412522, 1 | FloatDRU Memory Shortage | Data cannot be recorded more than 48 hours. | |
| 412523, 1 | LongTermDevice Memory Shortage | <ul style="list-style-type: none"> VR-7000: Data cannot be recorded more than "720 hours + used hours in SAVE areas". VR-7000S: Data cannot be recorded more than "48 hours + used hours in SAVE areas". | |
| 412524, 1 | UserDisk Memory Shortage | Data cannot be recorded more than setting hours. | Contact your dealer. |

| ID | Title | Description | Action |
|------------------------------|--|---|---|
| 412525, 1 | Sensor(LAN) Buffer Overflow | Serial, analog and digital data from Sensor Adapter are not recorded to Fixed DRU, Float-free DRU and Long Term Device. | If the error re-occurs, contact your dealer. |
| 412527, 1 | Image(LAN) Buffer Overflow | Image data from RADAR/ECDIS are not recorded to Fixed DRU, Float-free DRU and Long Term Device. | |
| 412531, 1 to 412538, 1 | No No.x Sensor Adapter Connection (x: 1 - 8) | No. x Sensor Adapter is missing (x: 1 - 8). | Contact your dealer. |
| 412541, 1 | No No.1 VIDEO LAN Converter Connection | No.1 VIDEO LAN Converter is missing. | |
| 412542, 1 | No No.2 VIDEO LAN Converter Connection | No.2 VIDEO LAN Converter is missing. | |
| 412581, 1 to 412583, 1 | No No.x ECDIS Attached information Input (No.1 - No.3) | No.x ECDIS has been powered off and the attached information is not received (x: 1 - 3). | Turn on the No. x ECDIS (x: 1 - 3). If the error re-occurs, contact your dealer. |
| 412601, 1 | No Radar1 Recording Image Input | Image input channel that is not valid for No.1 Radar setting is set. | Turn on the No. 1 or No. 2 Radar. If the error re-occurs, contact your dealer. |
| 412602, 1 | No Radar2 Recording Image Input | Image input channel that is not valid for No.2 Radar setting is set. | |
| 412603, 1 | No ECDIS Recording Image Input | Image input channel that is not valid for ECDIS setting is set. | Turn on the ECDIS. If the error re-occurs, contact your dealer. |
| 412604, 1 | No Additional Recording Image Input | Image input channel that is not valid for Additional setting is set. | Turn on the additional units. If the error re-occurs, contact your dealer. |
| 412605, 1 | No General1 Recording Image Input | Image input channel that is not valid for No.1 General setting is set. | Turn on the No. 1 or No. 2 General. If the error re-occurs, contact your dealer. |
| 412606, 1 | No General2 Recording Image Input | Image input channel that is not valid for No.2 General setting is set. | |
| 412611, 1 to 412614, 1 | No. x Radar Unrecognized Image (x: 1 - 4) | VDR does not support the format of image data from No. x Radar (x: 1 - 4). | Contact your dealer. |
| 412615, 1 to 412617, 1 | No.x ECDIS Unrecognized Image (x: 1 - 3) | VDR does not support the format of image data from No. x ECDIS (x: 1 - 3) | |
| 412801, 1 to 412816, 1 | No yy (yy: Equipment name) | No. xx serial channel has not received correct format data from a connected serial device (xx: 01 - 16). | Check the equipment name on the RAP and confirm that the applicable sensor is operating correctly. If the sensor is operating correctly, contact your dealer. |
| 412817, 1 to 412880, 1 | No yy (yy: Equipment name) | No. xx sensor (LAN) channel has not received correct format data from a connected sensor (LAN) device (xx: 01 - 64). | |
| 412901 | Liveplay Not Available | The live play is not available because the remote playback function is activated. | Deactivate the remote playback function to use the live play function. |

3.2.2 Alert list for Legacy mode

Only no. 412439 alert "Fatal System Error" corresponds to warning priority and all other alerts to caution priority.

| Alert no. | Alert name | Description | Action |
|-----------|---|---|---|
| 412026 | GPS Large Time Difference | This indicates that the time difference between the system time of the DCU and the UTC time supplied by a GPS receiver is more than 10 seconds. | Restart the DCU with the GPS receiver connected. To restart the VDR, open the DCU door with its key and turn on the AC and BATTERY switches on the power control panel, then turn the switches on after shutdown of the DCU. If the error re-occurs, contact your dealer. |
| 412082 | No RAP Connection (No DCU Connection) | DCU: RAP is missing. Connection to RAP is lost. RAP: DCU is missing. Connection to DCU is lost. | Restart the DCU. To restart the VDR, open the DCU door with its key and turn on the AC and BATTERY switches on the power control panel, then turn the switches on after shutdown of the DCU. If the error re-occurs, contact your dealer. |
| 412083 | No AMS1 Connection | AMS1 is missing. Connection to AMS1 is lost. | Check cable connected to AMS1. Reconnect AMS1. |
| 412085 | No AMS2 Connection | AMS2 is missing. Connection to AMS2 is lost. | Check cable connected to AMS2. Reconnect AMS2. |
| 412088 | No JB Connection | Indicates that Junction Box (IF-8530) is missing. | Check cable connected to Junction Box. Reconnect Junction Box. If the error re-occurs, contact your dealer. |
| 412170 | VDR Configuration Failure | Data cannot be stored because of abnormal VDR configuration. | Restore VDR config data. If the error re-occurs, contact your dealer. |
| 412171 | Recording Buffer Overflow | A image exceeding a recording buffer is input. | Contact your dealer. |
| 412173 | Fatal System Failure | Fatal system error. Reboot automatically after an error occurred. | If the error re-occurs, contact your dealer. |
| 412175 | LongTermDevice is stopped from recovering | The data cannot be recorded to the long term device more than ten minutes. | Restart VDR. To restart the VDR, open the DCU door with its key and turn on the AC and BATTERY switches on the power control panel, then turn the switches on after shutdown of the DCU. If the error re-occurs, contact your dealer. |
| 412176 | FixedDRU is stopped from recovering | The data cannot be recorded to the Fixed DRU more than ten minutes. | |

| Alert no. | Alert name | Description | Action |
|-------------------------|--|---|---|
| 412177 | FloatDRU is stopped from recovering | The data cannot be recorded to the Float-free DRU more than ten minutes. | Confirm that the capsule is seated in the bracket correctly, then restart VDR. To restart the VDR, open the DCU door with its key and turn on the AC and BATTERY switches on the power control panel, then turn the switches on after shutdown of the DCU. If the error re-occurs, contact your dealer. |
| 412181 | FixedDRU Setting Defect | Fixed DRU information is read, even though settings are not complete. | Contact your dealer. |
| 412182 | FloatDRU Setting Defect | Float DRU information is read, even though settings are not complete. | |
| 412185 | SAVE Setting Difference | SAVE function settings differ between VDR and RAP. | Confirm VDR and RAP settings. |
| 412186 | RAP Version is old | RAP/mod.tgz program version is not compatible with the DCU program version. | Contact your dealer. |
| 412187 | Module Version is old | | |
| 412214 | Running on batteries | AC power is down and the battery is running. | Reconnect AC power. |
| 412218 | MIC Test Failure | This alert is issued when the microphone test fails. The microphone test is run every 12 hours during normal operation. | Contact your dealer. |
| 412234 | No GPS Connection | System has not received UTC information. | Check that a valid UTC source (GPS receiver) is connected to the serial port. If the error re-occurs, contact your dealer. |
| 412246 | PDU Failure | The cable between PDU and CPU block is not connected. | Contact your dealer. |
| 412254 | Self Test Failure | System failed by the self test. | |
| 4123xx (xx: 01 - 16) | No No.xx Serial Connection (xx: 01 - 16) | No. xx serial channel has not received correct format data from a connected serial device (xx: 01 - 16). | Check the sentences input from the serial channel on the RAP and confirm that the applicable sensor is operating correctly. If OK, contact your dealer. |
| 4123xx (xx: 17 - 80) | No No.xx Sensor (LAN) Connection (xx: 01 - 64) | No. xx sensor (LAN) channel has not received correct format data from a connected sensor (LAN) device (xx: 01 - 64). | Check the sentences input from the LAN channel on the RAP and confirm that the applicable sensor is operating correctly. If OK, contact your dealer. |
| 412401 | No Battery Connection or Low Battery Voltage | No battery input or voltage is too low. | Confirm that the battery switch is turned on. If ON, recharge or replace the battery. |

3. TROUBLESHOOTING

| Alert no. | Alert name | Description | Action |
|-----------|---|---|--|
| 412431 | Serial Buffer Overflow | Serial data from DCU serial channel (1 - 8 ch) are not recorded to Fixed DRU, Float-free DRU and Long Term Device. | Restart VDR. To restart the VDR, open the DCU door with its key and turn on the AC and BATTERY switches on the power control panel, then turn the switches on after shutdown of the DCU. If the error re-occurs, contact your dealer. |
| 412432 | JB Buffer Overflow | Serial, analog and digital data from Junction Box (IF-8530) are not recorded to Fixed DRU, Float-free DRU and Long Term Device. | |
| 412437 | Fatal System Failure | Fatal system error. This indicates that VDR can not be rebooted automatically. | |
| 412438 | System Information Error (VDR System Information Error) | VDR system information can not be acquired. Usually, this error is recovered automatically. | If error is not recovered automatically, restart VDR. To restart the VDR, open the DCU door with its key and turn on the AC and BATTERY switches on the power control panel, then turn the switches on after shutdown of the DCU. If it does not recover, contact your dealer. |
| 412439 | Fatal System Error | Temperature of CPU system high and long term device is turned off. | Restart VDR. To restart the VDR, open the DCU door with its key and turn on the AC and BATTERY switches on the power control panel, then turn the switches on after shutdown of the DCU. If the error re-occurs, contact your dealer. |
| 412451 | High CPU Core Temperature | Temperature of CPU core is high. | |
| 412452 | High CPU System Temperature (CPU Board System Temperature High) | Temperature of CPU board is high. | |
| 412453 | CPU +3.3V Voltage Error (CPU Board +3.3V Voltage Error) | Voltage error on CPU board. (+3.3 V line) | |
| 412454 | CPU +5V Voltage Error (CPU Board +5V Voltage Error) | Voltage error on CPU board. (+5 V line) | |
| 412455 | CPU +12V Voltage Error (CPU Board +12V Voltage Error) | Voltage error on CPU board. (+12 V line) | |
| 412456 | CPU VCORE Voltage Error (CPU Board VCORE Voltage Error) | Voltage error on CPU board. (VCORE line) | |
| 412457 | Low CPU Battery Voltage (CPU Board Battery Voltage Lower) | Voltage of battery on CPU board is low. | |
| 412458 | Low CPU FAN Rotation Speed | Rotation speed of CPU FAN is low. | |
| 412459 | CPU FAN Not Rotated | CPU FAN stopped. | |
| 412460 | Low External FAN1 Rotation Speed | Rotation speed of external FAN1 is low. | |
| 412461 | External FAN1 Not Rotated | External FAN1 stopped. | |

| Alert no. | Alert name | Description | Action |
|-----------|----------------------------------|--|---|
| 412462 | Low External FAN2 Rotation Speed | Rotation speed of external FAN2 is low. | Restart VDR. To restart the VDR, open the DCU door with its key and turn on the AC and BATTERY switches on the power control panel, then turn the switches on after shutdown of the DCU. If the error re-occurs, contact your dealer. |
| 412463 | External FAN2 Not Rotated | External FAN2 stopped. | |
| 412501 | No FixedDRU Connection | Fixed DRU has been disconnected more than 600 seconds. | Check the connection with the Fixed DRU. If OK, contact your dealer. |
| 412502 | No FloatDRU Connection | Float-free DRU has been disconnected more than 600 seconds. | Check that the capsule is seated in the bracket correctly. If OK, contact your dealer. |
| 412503 | No LongTermDevice Connection | Long Term Device has been disconnected more than 600 seconds. | Contact your dealer. |
| 412504 | No UserDisk Connection | UserDisk has been disconnected more than 600 seconds. | |
| 412511 | FixedDRU Recording Failure | Fixed DRU is unable to write. | Check the connection with the Fixed DRU. If OK, contact your dealer. |
| 412512 | FloatDRU Recording Failure | Float-free DRU is unable to write. | Check that the capsule is seated in the bracket correctly. If OK, contact your dealer. |
| 412513 | LongTermDevice Recording Failure | Long Term Device is unable to write. | Restart the VDR. |
| 412514 | UserDisk Recording Failure | UserDisk is unable to write. | |
| 412515 | FixedDRU Exchanged | Fixed DRU is replaced. | |
| 412516 | FloatDRU Exchanged | Float-free DRU is replaced. | |
| 412517 | LongTermDevice Exchanged | Long Term Device is replaced. | |
| 412518 | No.1 LongTermDevice Error | No.1 Long Term Device is error. | |
| 412519 | No.2 LongTermDevice Error | No.2 Long Term Device is error. | |
| 412521 | FixedDRU Memory Shortage | Data cannot be recorded more than 48 hours. | Contact your dealer. |
| 412522 | FloatDRU Memory Shortage | Data cannot be recorded more than 48 hours. | |
| 412523 | LongTermDevice Memory Shortage | <ul style="list-style-type: none"> • VR-7000: Data cannot be recorded more than "720 hours + used hours in SAVE areas". • VR-7000S: Data cannot be recorded more than "48 hours + used hours in SAVE areas". | |

3. TROUBLESHOOTING

| Alert no. | Alert name | Description | Action |
|----------------------|--|---|--|
| 412524 | UserDisk Memory Shortage | Data cannot be recorded more than setting hours. | Contact your dealer. |
| 412525 | Sensor(LAN) Buffer Overflow | Serial, analog and digital data from Sensor Adapter are not recorded to Fixed DRU, Float-free DRU and Long Term Device. | If the error re-occurs, contact your dealer. |
| 412527 | Image(LAN) Buffer Overflow | Image data from RADAR/ECDIS are not recorded to Fixed DRU, Float-free DRU and Long Term Device. | |
| 41253x (x: 1 - 8) | No No.x Sensor Adapter Connection (x: 1 - 8) | No. x Sensor Adapter is missing (x: 1 - 8). | Contact your dealer. |
| 412541 | No No.1 VIDEO LAN Converter Connection | No.1 VIDEO LAN Converter is missing. | |
| 412542 | No No.2 VIDEO LAN Converter Connection | No.2 VIDEO LAN Converter is missing. | |
| 412545 | No Audio IF Board Connection | Audio IF Board is missing. | |
| 41255x (x: 1 - 4) | No No.x Radar Input Image (x: 1 - 4) | No.x Radar has been powered off and the image data is not received (x: 1 - 4). | Turn on the No. x Radar (x: 1 - 4). If the error re-occurs, contact your dealer. |
| 41255x (x: 5 - 7) | No No. x ECDIS Input Image (x: 1-3) | No.x ECDIS has been powered off and the image data is not received (x: 1 - 3). | Turn on the No. x ECDIS (x: 1 - 3). If the error re-occurs, contact your dealer. |
| 41258x (x: 1 - 3) | No No.x ECDIS Attached information Input (No.1 - No.3) | No.x ECDIS has been powered off and the attached information is not received (x: 1 - 3). | |
| 412601 | No Radar1 Recording Image Input | Image input channel that is not valid for No.1 Radar setting is set. | Turn on the No. 1 or No. 2 Radar. If the error re-occurs, contact your dealer. |
| 412602 | No Radar2 Recording Image Input | Image input channel that is not valid for No.2 Radar setting is set. | |
| 412603 | No ECDIS Recording Image Input | Image input channel that is not valid for ECDIS setting is set. | Turn on the ECDIS. If the error re-occurs, contact your dealer. |
| 412604 | No Additional Recording Image Input | Image input channel that is not valid for Additional setting is set. | Turn on the additional units. If the error re-occurs, contact your dealer. |
| 412605 | No General1 Recording Image Input | Image input channel that is not valid for No.1 General setting is set. | Turn on the No. 1 or No. 2 General. If the error re-occurs, contact your dealer. |
| 412606 | No General2 Recording Image Input | Image input channel that is not valid for No.2 General setting is set. | |
| 41261x (x: 1-4) | No. x Radar Unrecognized Image (x: 1 - 4) | VDR does not support the format of image data from No. x Radar (x: 1 - 4). | Contact your dealer. |
| 41261x (x: 5-7) | No.* ECDIS Unrecognized Image (x: 1 - 3) | VDR does not support the format of image data from No. x ECDIS (x: 1 - 3) | |

| Alert no. | Alert name | Description | Action |
|-------------------------|-------------------------------|--|---|
| 4128xx (xx: 01 - 16) | No yy (yy: Equipment name) | No. xx serial channel has not received correct format data from a connected serial device (xx: 01 - 16). | Check the equipment name on the RAP and confirm that the applicable sensor is operating correctly. If the sensor is operating correctly, contact your dealer. |
| 4128xx (xx: 17 - 80) | No yy (yy: Equipment name) | No. xx sensor (LAN) channel has not received correct format data from a connected sensor (LAN) device (xx: 01 - 64). | |
| 412901 | Liveplay Not Available | The live play is not available because the remote playback function is activated. | Deactivate the remote playback function to use the live play function. |

3. TROUBLESHOOTING

This page is intentionally left blank.

4. REMOTE PLAYBACK FUNCTION (LAND-SHIP COMMUNICATION)

You can replay or extract the data from the PC on the shore by connecting the PC to the on-board VDR through the satellite link.

Operate the Live Player V5 to use the remote playback function. For how to use the remote playback function, see the Live Player V5 operator's manual (OME-44851).

This chapter explains the preparation and limitations about the remote playback function, and recommended network configuration.

4.1 Preparations

The following preparations are required to connect an on-shore PC to the on-board VDR:

- The land-ship connection through a satellite link (ex. VSAT) must be established by VPN connection. Check the communication between the on-shore PC and on-board VDR, by sending a Ping request to the specified IP address.
- Configure the firewall to allow access to all network ports used for the land-ship communication. This setting must be applied to all network devices. For the network ports used by the VDR and Live Player V5, consult your dealer.
- The VDR must be configured to activate the remote playback function. Contact your dealer to activate the remote playback function.
- When you want to connect the PC multiple VDRs, a unique IP address is required for each VDR.
- The remote playback function uses UDP communication. Therefore, it is recommended that the router on the communication path is compatible with the Path MTU Discovery function.
- It is recommended to use a fixed charge satellite line for the remote playback function. If you use a satellite line with a meter-rate system, communication cost may become expensive.

4.2 Limitations and Notifications

Keep in mind the following limitations and notifications to use the remote playback function.

- Both of the DCU and Live Player V5 program versions must be "01.30" or later.
- The following functions are available by using the remote playback function:
 - Remote live play ([Live (Remote)])
 - Data extraction by LAN connection ([Long Term Device (LAN)] or [Long Term Device (Save Area)])
- The remote replay function is not available when the on-board PC (Live Player V5) is connecting to the VDR by LAN connection or RAP is extracting the data.

4. REMOTE PLAYBACK FUNCTION (LAND-SHIP COMMUNICATION)

- The following communication environment is recommended to use the remote playback function:
 - Average baud rate: 80 kbps or higher
 - Packet loss rate: Less than 5%
 - Average communication delay: Less than 1200 msec
- When you establish a VPN connection from the shore, the network segment on the shore must be different from the VDR network segment. VDR network segment is as follows:
 - 10.0.0.xxx/255.255.255.0: Change the VDR subnet address.
 - 172.31.xxx.xxx/255.255.0.0
 - 192.168.31.xxx/255.255.255.0: Used only for applicable vessels.

4.3 Recommended Network Construction

The following figure shows the recommended network construction for remote playback functions:

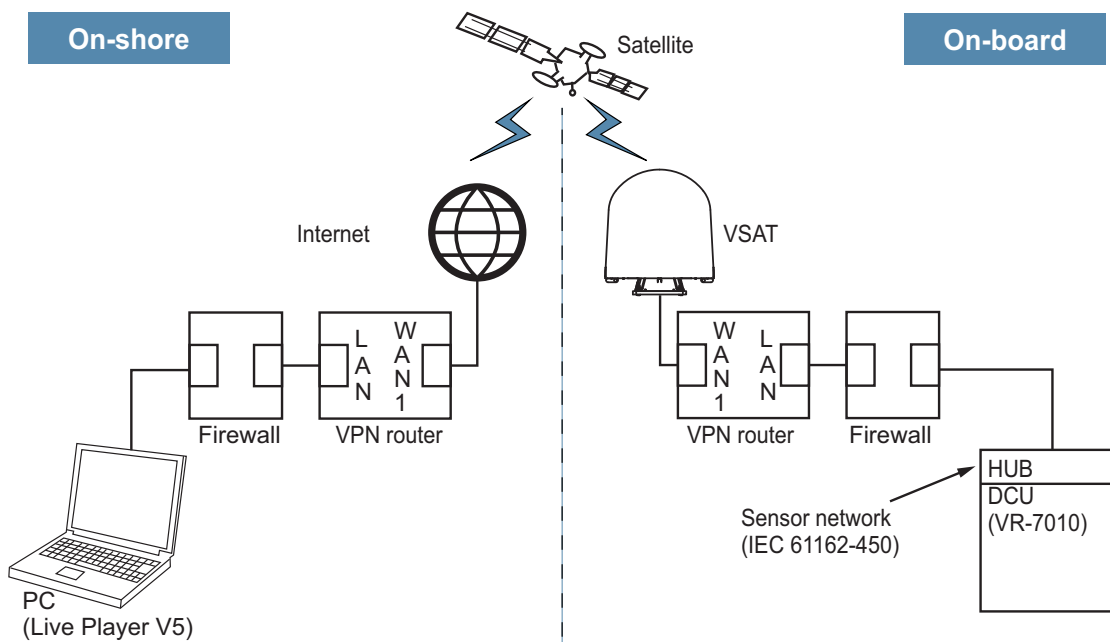

IP address setting examples

| | |
|-----------------|--|
| On-shore | |
| VPN Router WAN1 | Fixed global IP address is recommended. |
| VPN Router LAN | 192.168.5.1/255.255.255.0 |
| PC | 192.168.5.101/255.255.255.0 Default gateway: 192.168.5.1 |
| On-board | |
| VPN Router WAN1 | Fixed global IP address is recommended. |
| VPN Router LAN | 192.168.6.1/255.255.255.0 |
| DCU (VR-7010) | No.2 IP address for IEC 61162-450 network: 192.168.6.101/255.255.255.0 Default gateway: 192.168.6.1 |

Note: The IP addresses on the table above are only one example.

APPX. 1 MENU ITEMS

Below are the menu items for the Remote Alarm Panel (RAP). To open this menu, press the **MENU/ESC** key.

| Menu item | Function |
|---|---|
| Execute SAVE Function (only for VR-7000S) | Records the data, which are recorded to the capsule, to area1 (or 2, 3, 4) in the long term device(s) |
| Serial Monitor | Displays the sensor information input to the serial channels on the Serial Monitor screen. |
| Sensor(LAN) Monitor | Displays the sensor information input to the LAN channels on the Sensor (LAN) Monitor screen. |
| Analog Monitor | Displays the sensor information input to the analog channels on the Analog Monitor screen. |
| Digital Monitor | Displays the sensor information input to the digital channels on the Digital Monitor screen. |
| Image Capture Status | Displays the information of the images recorded in the DCU on the Image Capture Status screen. |
| Audio Monitor | Displays the status of the microphones and communications equipment (VHF, etc.) on the Audio Monitor screen. |
| Life Parts List | Displays the lifetimes of the parts on the Life Parts List screen. |
| Status Monitor | Displays the status of the system on the Status Monitor screen. |
| Settings | <ul style="list-style-type: none">• Key Beep: Turns key beep on or off. (ON, OFF)• [Brilliance Sync]: Turn the brilliance sharing function on or off. (ON, OFF)• [Brilliance Sync Settings]: Adjust the preset setting value for the brilliance sharing.• Serviceman Settings: No use. |

APPX. 2 PARTS LIST/LOCATION

Parts list

This equipment contains complex modules in which fault diagnosis and repair down to component level are not practical (IMO A.694(17)/8.3.1). Only some discrete components are used. FURUNO Electric Co., Ltd. believes identifying these components is of no value for shipboard maintenance; therefore, they are not listed in this manual. Major modules can be located on the parts location photos on the next page.

| ELECTRICAL PARTS LIST | Unit | Data Collecting Unit VR-7010 |
|------------------------------|------|------------------------------|
| Code No. | | |
| PRINTED CIRCUIT BOARD | | |
| ADP-586-31/ADP-216-01, CPU | | — |
| 24P0135/24P0148, PDU | | — |
| 24P0137, HUB | | — |
| 24P0137A, HUB | | — |
| 24P0133, TB | | — |
| 24P0141/24P0149, FIL | | — |
| 24P0138, LED | | — |
| 24P0134, AUDIO | | — |

| ELECTRICAL PARTS LIST | Unit | Video LAN Converter IF-7100 |
|------------------------------|------|-----------------------------|
| Code No. | | |
| PRINTED CIRCUIT BOARD | | |
| 24P0132, VLC | | — |

| ELECTRICAL PARTS LIST | Unit | Remote Alarm Panel VR-7017 |
|------------------------------|------|----------------------------|
| Code No. | | |
| PRINTED CIRCUIT BOARD | | |
| 24P0139, PWR | | — |
| 20P8200C, MAIN | | — |

| ELECTRICAL PARTS LIST | Unit | Microphone VR-7011 |
|------------------------------|------|--------------------------------|
| | | Waterproof Microphone VR-7012W |
| Code No. | | |
| PRINTED CIRCUIT BOARD | | |
| 24P0136, MIC | | — |

| ELECTRICAL PARTS LIST | Unit | Sensor Adapter MC-3000S |
|------------------------------|------|-------------------------|
| Code No. | | |
| PRINTED CIRCUIT BOARD | | |
| 24P0114, MC-CS | | — |

Parts location

Data Collecting Unit (VR-7010)

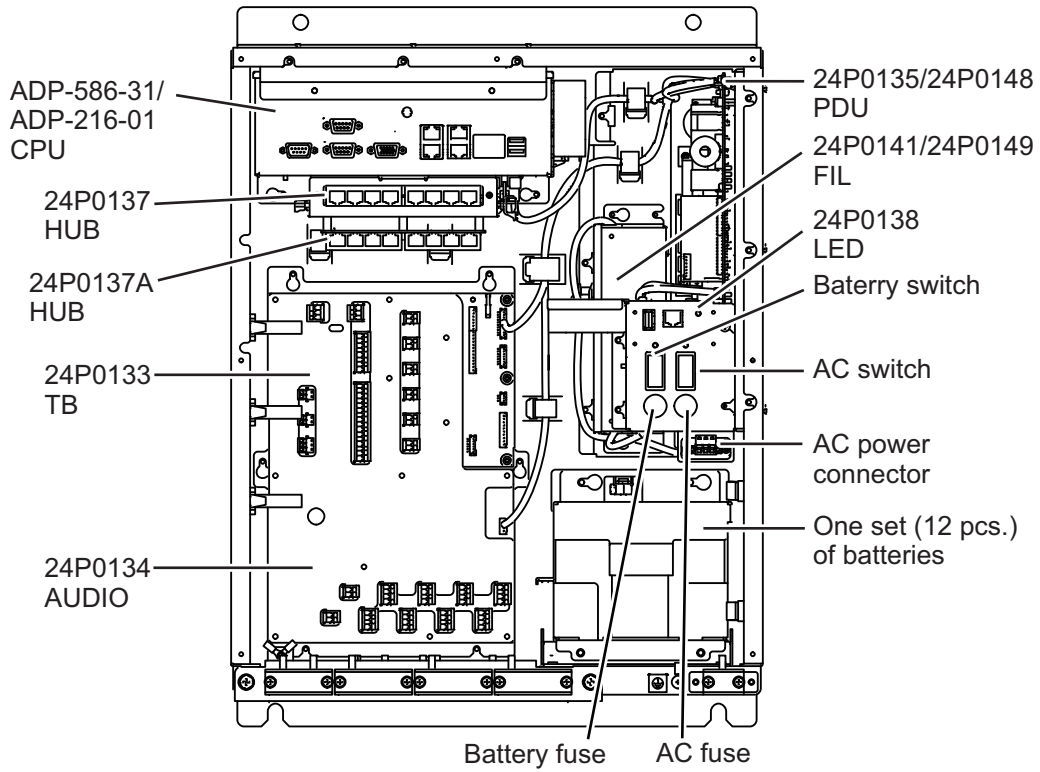

Video LAN Converter (IF-7100)

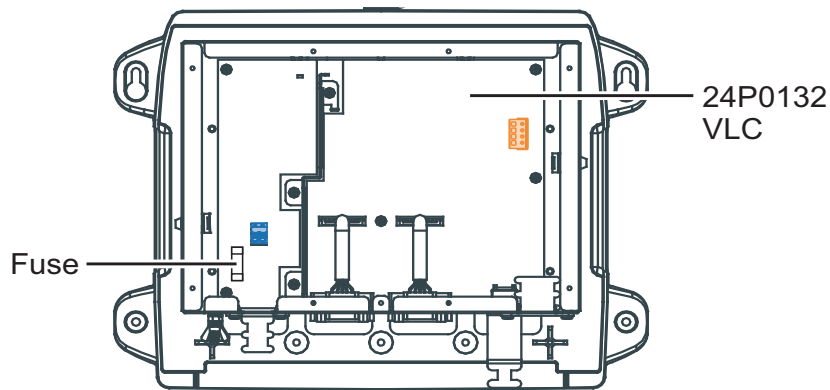

Remote Alarm Panel (VR-7017)

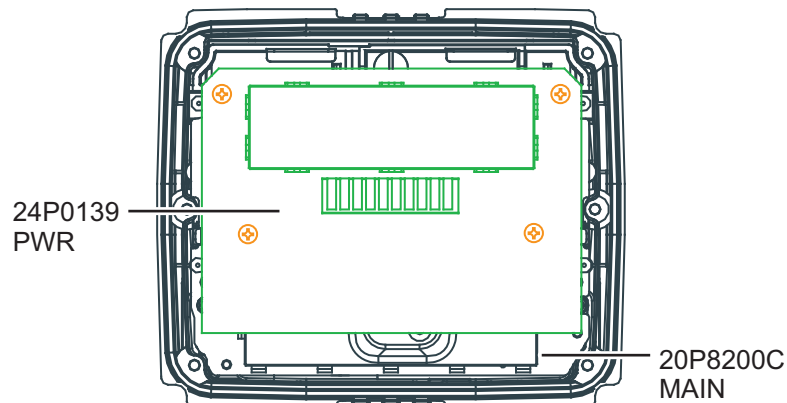

Microphone (VR-7011), Waterproof Microphone (VR-7012W)

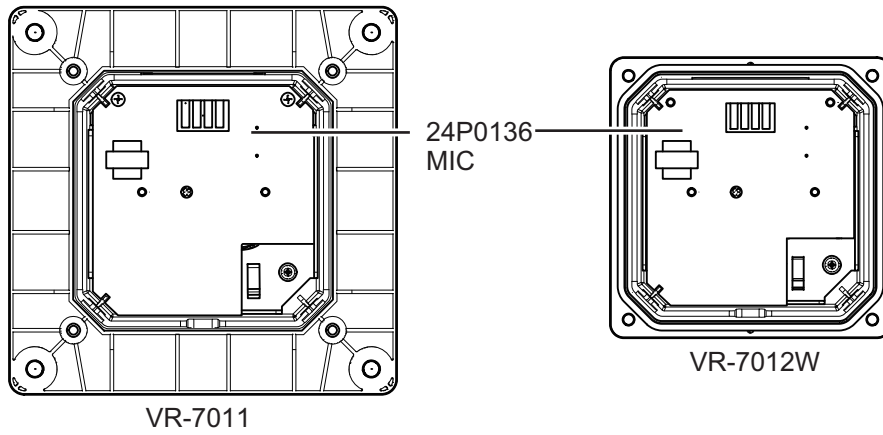

Sensor Adapter (MC-3000S)

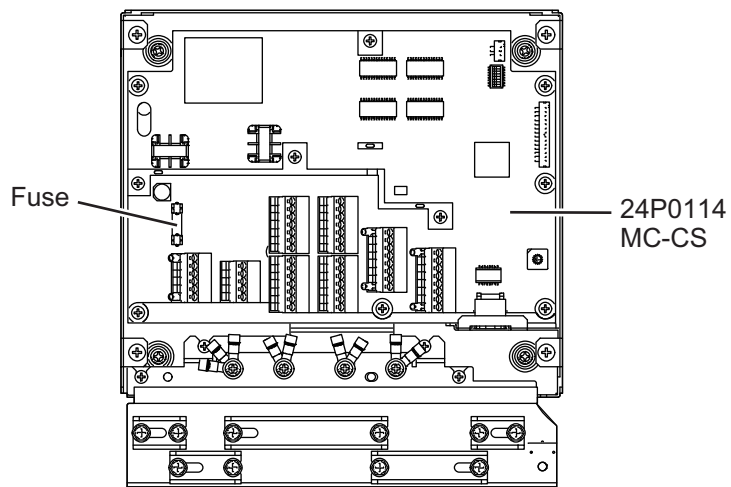







APPX. 3 LIST OF TERMS AND ABBREVIATIONS/SYMBOLS

The following table shows the terms, abbreviations and symbols used in the VR-7000/7000S.

Terms and abbreviations

| Term | Abbreviation | Term | Abbreviation |
|---|--------------|----------------------------|--------------|
| Alternate current | AC | Local Area Network | LAN |
| Additional | ADD | Liquid Crystal Display | LCD |
| Alert | ALERT | Light Emitting Diode | LED |
| Alarm Management System | AMS | LAN | LN |
| Analog Channel | AN | Main | MAIN |
| Audio | AUDIO | Menu | MENU |
| Brilliance | BRILL | Microphone | MIC |
| Complementary Metal-Oxide Semiconductor | CMOS | Power Distribution Unit | PDU |
| Central Processing Unit | CPU | Power | PWR |
| Digital Channel | DC | Radar | RADAR |
| Data Collecting Unit | DCU | Random Access Memory | RAM |
| Difference | DIFF | Remote Alarm Panel | RAP |
| Data Recording Unit | DRU | Read Only Memory | ROM |
| Electronic Chart Display and Information System | ECDIS | Serial | SI |
| Enter | ENT | Solid State Drive | SSD |
| Emergency Position-Indicating Radio Beacon | EPIRB | System | SYS |
| Escape | ESC | Terminal | TERMINAL |
| Fan | FAN | Universal Serial Bus | USB |
| Filter | FIL | Universal Time Coordinated | UTC |
| Global Positioning System | GPS | Voltage of Core | VCORE |
| Hub | HUB | Voyage Data Recorder | VDR |
| Identification | ID | Very High Frequency | VHF |
| Interface | IF | Video | VIDEO |
| Junction Box | JB | Video LAN Converter | VLC |

Alert icons

| Icon | Alert state | Visual Indication | Audible alert |
|---|--|-------------------------|--|
| Alert priority: Warning (Legacy mode only) | | | |
|  | Not acknowledged/ Not rectified | Yellow-orange, flashing | 2 short, audible alerts repeated every 60 seconds. |
|  | Not acknowledged/ Not rectified, Buzzer temporarily silenced | Yellow-orange, flashing | Silent |
|  | Acknowledged/ Not rectified | Yellow-orange | Silent |
|  | Not acknowledged/ Rectified | Yellow-orange, flashing | Silent |
| Alert priority: Caution | | | |
|  | Caution | Yellow | Silent |
| Alert priority: Indication (BAM mode only) | | | |
|  | Indication | Yellow | Silent |

APPX. 4 PLAYING BACK RECORDED DATA

IMO Circular MSC.214(81) recommends that all VDR systems installed on or after 1 June 2008 carry software to playback data on a PC, the manual for data extraction, and the cable necessary to connect the PC to the Data Collecting Unit (DCU). Attach the supplied card holder to the front door of the DCU to store the items listed in the table below.

Items to store in the card holder

| Name | Type | Code No. | Remarks |
|---------------------------|----------------------|----------------|--------------------------------|
| CD-ROM (For Live Player) | VR-7030 SW&MANUAL CD | 000-191-754 | With Accessories FP24-01110 |
| Data Extraction Procedure | E42-01402 | 000-179-354 | |
| LAN Cable Assembly | MOD-Z072-020+ | 001-167-880-10 | |

See the data extraction procedure for how to play back data.

How to attach the card holder

Use the supplied accessories to attach the card holder to the DCU.

Remove the paper from the double-sided tape on the card holder. Attach the card holder to the location in the DCU shown below.

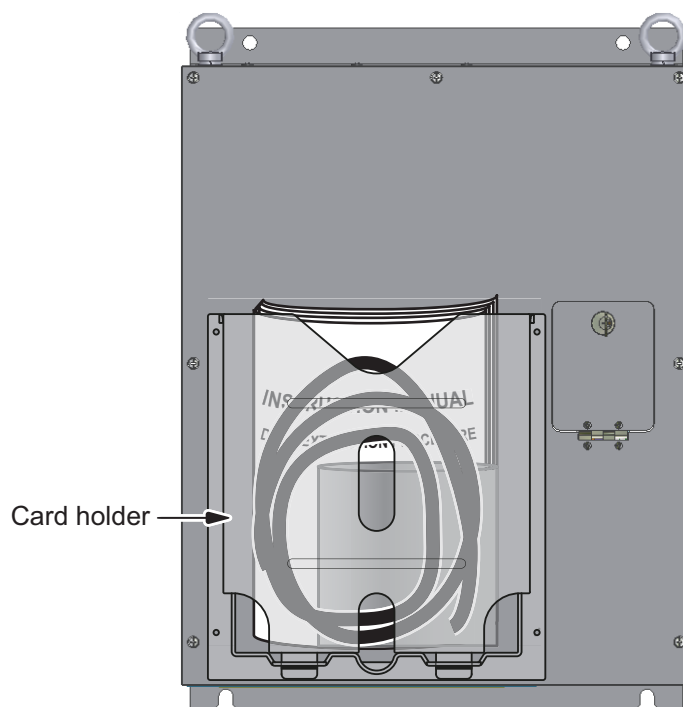

**SPECIFICATIONS OF
VOYAGE DATA RECORDER VR-7000
SIMPLIFIED VOYAGE DATA RECORDER VR-7000S**

The Voyage Data Recorder (VDR) is a recording system required on certain categories of ships from 1st July 2002 by the revised SOLAS Chapter V. VR-7000/7000S fully complies with the IMO Resolution MSC.333 (90) and IEC 61996-1/2 testing standard.

1 GENERAL

- 1.1 Recording period
 - Data recording unit 48 hrs (Fixed DRU or Float-free DRU selected for VR-7000S)
 - Long term device (long-term recording medium) 720 hrs
- 1.2 Battery backup More than two hours after loss of ship's mains

2 DATA COLLECTING UNIT (DCU)

- 2.1 CPU Board (either one)
 - ADP-586-31 Intel Celeron P4505 1.86 GHz
 - ADP-216-01 Intel Atom x5-E3940 1.6 GHz
- 2.2 Long term device
 - Memory capacity 512 GB or 1 TB (SSD)
 - Minimum data retention period 2 years after recording

3 REMOTE ALARM PANEL

- 3.1 Display 4.3-inch color LCD, 480 x 272 (WQVGA)
- 3.2 Picture color 256 colors
- 3.3 Brilliance 0.2 to 700 cd/m²
- 3.4 Visible distance 0.5 m nominal

4 DATA RECORDING UNIT (DRU)

- 4.1 Fixed DRU
 - Chassis Protective capsule (metal)
 - Memory capacity 32 GB
 - Minimum data retention period 2 years after recording
 - Shock resistance 50G x 11 ms
 - Penetration resistance 100mm diameter pin with 250 kg weight, dropped from 3 m height
 - Fire resistant 1100°C for 1 hour, 260°C for 10 hours
 - Submersible 6000 m (60MPa)
 - Acoustic beacon Battery life: 3 years from the date of insertion,
37.5kHz, 10ms pulse transmission,
Maximum depth: 6000m
Operating life: 90 days
- 4.2 Float-free DRU
 - Chassis Auto-float capsule
 - Memory capacity 64 GB (VR-7021F), 80 GB (VR-7024F)
 - Minimum data retention period 6 months after recording
 - Battery Primary Lithium-Thionyl Chloride (VR-7021F),
Lithium Metal (VR-7024F), 7.2 V/ 18 Ah, 5 years service life

| | |
|---------------------------------|--|
| Operating life | Minimum 168 hrs at -20°C |
| Release mechanism | Hydrostatic release unit (released at water depth 4 m) |
| Supported GNSS constellations | GPS (VR-7021F), GPS, GLONASS, Galileo (VR-7024F) |
| COSPAS-SARSAT Transmitter | |
| Frequency | 406.037 MHz ± 2 ppm (VR-7021F), 406.031 MHz (VR-7024F) |
| Output power | 5 W |
| Homing Transmitter | |
| Frequency | 121.500 MHz |
| Output power | Up to 100 mW |
| Modulation | AM sweep tone (A9) |
| Sweep range | 700 Hz |
| Sweep rate | 2.5 Hz |
| AIS transmitter (VR-7024F only) | |
| Frequency | 161.975 MHz (AIS 1), 162.025 MHz (AIS 2) |
| Output power | 1 W |

5 MICROPHONE

| | | |
|-----|------------------------|--|
| 5.1 | Reference signal level | 0 dBm/600 ohm at 91 dBA |
| 5.2 | Frequency response | Within 12 dB at 150Hz to 6 kHz |
| 5.3 | Audio coverage | Hemisphere area of 3.5 m approx. in radius |
| 5.4 | Test beeper | 3s in 12 hours period (built in) |

6 HUB (OPTION)

| | |
|--------------------------------|---|
| 6.1 Switching HUB (HUB-100) | |
| Number of ports | 8 ports (10Base-T/100Base-TX), Auto-MDI/MDI-X compliant |
| Switching Method | Store and forward |
| Buffer memory | SRAM |
| 6.2 Intelligent HUB (HUB-3000) | |
| Number of ports | 8 ports (10/100/1000Base-T) , Auto-MDI/MDI-X compliant |
| Switching Method | Store and forward, non-blocking L2 switching |
| Capacitance of switching | 16 Gbps |
| VLAN | Port-base VLAN, IEEE802.1Q Tag VLAN supported |
| Multiple VLAN | Communication between isolated ports is disabled |

7 INTERFACE

| | |
|--------------------------|--|
| 7.1 Data collecting unit | |
| Number of port | |
| LAN | 6 ports, Ethernet 100Base-TX, RJ45 connector 5 ports for IEC61162-450: IP address range 172.31.16.1-254, 172.31.17.1-254, default 172.31.16.200 1 port for internal: IP address 10.0.0.100 2 ports for Live Player or Data transmission (ADP-216-01 only) |
| Bridge audio (input) | 8 ch (0 dBm/600 ohm) |
| VHF audio (input) | 2 ch (0 dBm/600 ohm) |
| Serial | IEC61162-1/2: 2 ports, IEC61162-1: 6 ports |

| | |
|---|--|
| Serial I/O for AMS | IEC61162-1: 1 ch |
| USB | 1 port, USB2.0 for data extraction, User disk recording |
| Alarm (output) | 3 ch, contact signal, load current 30 mA System fail, Power fail, Local ACK |
| Remote ACK (input) | 1 ch |
| Buzzer stop (input) | 1 ch |
| IEC61162-450 transmission group | |
| Input | MISC, TGTD, SATD, NAVD, VDRD, RCOM, TIME, PROP, USR1 to USR8, BAM1/2, CAM1/2, NETA, PGP1 to PGP4, PGB1 to PGB4 |
| Output | Arbitrary (default: MISC) |
| Multicast address | 239.192.0.1 to 239.192.0.20, 239.192.0.56 to 239.192.0.64 |
| Destination port | 60001 to 60020, 60056 to 60064 |
| Datagram header | UdPbC |
| Re-transmittable binary image transfer (only receive) | |
| Multicast address | 239.192.0.26 to 239.192.0.30 |
| Destination port | 60026 to 60030 |
| Datagram header | RrUdP |
| IGMP | Version 1 |
| Other Network Function (except IEC61162-450) | |
| | HTTP; *.*.*.:80 VR-7000 replies on PC's ARP command and ping command Live player, Maintenance viewer - UDP multicast: 239.255.0.1 Port: 20001-20004, 21001-21004, 22001-22007, 23001-23007 27001-27010, 28001-28010 - TCP: *.*.*., Port: 20, 21, 10106, 24001, 24004 |
| Note: Traffic's effect has little to transfer for 2.3 Mbps in average and 3.3 Mbps maximum. | |
| I/O Sentences | |
| Input | All incoming |
| Output | ALC, ALF, ARC, DDC, HBT |
| 7.2 | Sensor adapter |
| | MC-3000S (serial) 8 ports: I/O, IEC61162-1/2: 4 ports, IEC61162-1: 4 ports |
| | MC-3010A (analog, option) 3 ports: Input, -10 to +10V, 0 to 10V or 4 to 20 mA |
| | MC-3020D (digital-in, option) 8 ports: relay contact, logics set from program |
| 7.3 | Video signal input |
| | Video LAN converter 2 ch (DVI/RGB selectable for each) SER.NO. 100000 to 199999: RGB is not available |
| | RGB VESA: VGA, SVGA, XGA, SXGA, UXGA (FAR-28x7/28x5 ser.) |
| | DVI VESA: VGA to SXGA, WXGA+*, UXGA, WUXGA, CEA: Full HD (FAR-28x7 ser.) |
| | *: FPGA program ver.01.03 or later and SER. NO. 200991 or later for IF-7100 |
| | IEC 61162-450 For PNG (24 bit, recording data compressed to JPEG: 32 or 48 bit, index color) or JPEG (baseline: SOF0, progressive: SOF2) |

Number of channels for picture recording

| Device | Video LAN converter IEC61162-450 PNG | IEC61162-450 JPEG | |
|--|--|-------------------|--------------|
| | | Quality ≥ 50 | Quality < 50 |
| Fixed/ float-free DRU or long term device (single) | UXGA: 2ch + full-HD: 1ch, Total 3ch | 3ch | 5ch |
| Long term device (dual) | UXGA: 2ch + full-HD: 1ch + WUXGA: 1ch, Total 4ch | 4ch | 6ch |

Picture recording pattern Selectable for each channel (Only one/Patrol/Backup)

8 POWER SUPPLY

- 8.1 Data collecting unit 100-230 VAC: 1.6-0.7 A, 1 phase, 50/60 Hz
- 8.2 Sensor adapters 24 VDC: 1.4 A max.(11 units), fed from DCU
- 8.3 Video LAN converter (IF-7100, option) 24 VDC: 0.3 A (SER.NO. 100000 to 199999: 0.7 A)
- 8.4 HUB (option)
 - HUB-3000 100-230 VAC: 0.1 A, 1 phase, 50-60 Hz
 - HUB-100 100-230 VAC: 0.1 A, 1 phase, 50-60 Hz

9 ENVIRONMENTAL CONDITIONS

- 9.1 Ambient temperature
 - Data collecting unit -15°C to +55°C
 - Fixed DRU -25°C to +55°C
 - Float-free DRU -20°C to +55°C
 - Waterproof microphone -25°C to +55°C
 - Others -15°C to +55°C
- 9.2 Relative humidity 93% or less at +40°C
- 9.3 Degree of protection
 - Data collecting unit IP20
 - Fixed DRU IP56 equivalent
 - Float-free DRU IP67 equivalent
 - Remote alarm panel IP22 (front panel), IP20 (chassis)
 - Sensor adapter IP20 (IP22: option)
 - Junction box IP20 (IF-8540), IP56 (VR-7022F)
 - Video LAN converter IP22
 - Microphone IP22 (panel), IP20 (chassis)
 - Waterproof microphone IP56
 - HUB-3000 IP20 (IP22: option)
 - HUB-100 IPX0
- 9.4 Vibration IEC 60945 Ed.4

10 UNIT COLOR

- 10.1 Data collecting unit N2.5 (standard)
- 10.2 Fixed DRU Fluorescent orange (fixed)
- 10.3 Float-free DRU Fluorescent orange (chassis), White (bracket)
- 10.4 Remote alarm panel/ Video LAN converter/ Sensor adapter N2.5
- 10.5 Junction box N2.5 (IF-8540), 7.5BG7/2 (VR-7022F)
- 10.6 Microphone/ Waterproof microphone N2.5 (fixed)
- 10.7 HUB N2.5 (HUB-3000), N3.0 (HUB-100)

Declaration of Conformity



0560

We **FURUNO ELECTRIC CO., LTD.**

(Manufacturer)

9-52 Ashihara-Cho, Nishinomiya City, 662-8580, Hyogo, Japan

(Address)

declare under our sole responsibility that the product

VOYAGE DATA RECORDER VR-7000
(Serial No.1000-19xx-xxxx)

(Model name, type number)

to which this declaration relates conforms to the following standard(s) or normative document(s)

| | |
|----------------------------|--|
| IMO Resolution A.694(17) | IEC 61996-1 Ed.2.0: 2013, A1: 2021 |
| IMO Resolution MSC.36(63) | IEC 61162-1 Ed.5.0: 2016 |
| IMO Resolution MSC.97(73) | IEC 61162-2 Ed.1.0: 1998 |
| IMO Resolution MSC.191(79) | IEC 61162-450 Ed.2.0: 2018 |
| IMO Resolution MSC.302(87) | IEC 62288 Ed.2.0: 2014 |
| IMO Resolution MSC.333(90) | IEC 60945 Ed.4.0: 2002 incl. Corr. 1, 2008 |
| | IEC 61924-2 Ed.1.0: 2012 Annex K and M |
| | IEC 62923-1/2 Ed.1.0: 2018 |

(title and/or number and date of issue of the standard(s) or other normative document(s))

For assessment, see

- EC type examination (Module B) certificate No. MEDB000039E Rev.5 issued by DNV AS (0575), Norway.
- Product Quality System (Module D) certificate No. P 112 (Issue 67) issued by Telefication, The Netherlands.

This declaration is issued according to the Directive 2014/90/EU of the European Parliament and of the Council on marine equipment, and the Implementing Regulation (EU) 2022/1157.

On behalf of Furuno Electric Co., Ltd.

Nishinomiya City, Japan
28 November 2022

(Place and date of issue)

Akihiko Kanechika
Department General Manager
Quality Assurance Department

(name and signature or equivalent marking of authorized person)

Declaration of Conformity



0560

We **FURUNO ELECTRIC CO., LTD.**

(Manufacturer)

9-52 Ashihara-Cho, Nishinomiya City, 662-8580, Hyogo, Japan

(Address)

declare under our sole responsibility that the product

SIMPLIFIED VOYAGE DATA RECORDER VR-7000S
(Serial No.1000-58xx-xxxx)

(Model name, type number)

to which this declaration relates conforms to the following standard(s) or normative document(s)

| | |
|----------------------------|--|
| IMO Resolution A.694(17) | IEC 61996-1 Ed.2.0: 2013, A1: 2021 |
| IMO Resolution MSC.163(78) | IEC 61996-2 Ed.2.0: 2007 |
| IMO Resolution MSC.191(79) | IEC 61162-1 Ed. 5.0: 2016 |
| IMO Resolution MSC.302(87) | IEC 61162-2 Ed.1.0: 1998 |
| | IEC 61162-450 Ed.2.0: 2018 |
| | IEC 62288 Ed.2.0: 2014 |
| | IEC 60945 Ed.4.0: 2002 incl. Corr. 1, 2008 |
| | IEC 62923-1/2 Ed.1.0: 2018 |

(title and/or number and date of issue of the standard(s) or other normative document(s))

For assessment, see

- EC type examination (Module B) certificate No. MEDB00001MR Rev.7 issued by DNV AS (0575), Norway.
- Product Quality System (Module D) certificate No. P 112 (Issue 67) issued by Telefication, The Netherlands.

This declaration is issued according to the Directive 2014/90/EU of the European Parliament and of the Council on marine equipment, and the Implementing Regulation (EU) 2022/1157.

On behalf of Furuno Electric Co., Ltd.

Nishinomiya City, Japan
28 November 2022

(Place and date of issue)

Akihiko Kanechika
Department General Manager
Quality Assurance Department

(name and signature or equivalent marking of authorized person)