

# IMPORTANT NOTICES

---

## General

- This manual has been authored with simplified grammar, to meet the needs of international users.
- The operator of this equipment must read and follow the instructions in this manual. Wrong operation or maintenance can void the warranty or cause injury.
- Do not copy any part of this manual without written permission from FURUNO.
- If this manual is lost or worn, contact your dealer about replacement.
- The contents of this manual and the equipment specifications can change without notice.
- The example screens (or illustrations) shown in this manual can be different from the screens you see on your display. The screens you see depend on your system configuration and equipment settings.
- Save this manual for future reference.
- Any modification of the equipment (including software) by persons not authorized by FURUNO will void the warranty.
- The following concern acts as our importer in Europe, as defined in DECISION No 768/2008/EC.
  - Name: FURUNO EUROPE B.V.
  - Address: Ridderhaven 19B, 2984 BT Ridderkerk, The Netherlands
- The following concern acts as our importer in UK, as defined in SI 2016/1025 as amended SI 2019/470.
  - Name: FURUNO (UK) LTD.
  - Address: West Building Penner Road Havant Hampshire PO9 1QY, U.K.
- All brand, product names, trademarks, registered trademarks, and service marks belong to their respective holders.
- Windows is either registered trademarks or trademarks of Microsoft Corporation in the United States and/or other countries.

## How to discard this product

Discard this product according to local regulations for the disposal of industrial waste. For disposal in the USA, see the homepage of the Electronics Industries Alliance (<http://www.eiae.org/>) for the correct method of disposal.

## How to discard a used battery

Some FURUNO products have a battery(ies). To see if your product has a battery, see the chapter on Maintenance. If a battery is used, tape the + and - terminals of the battery before disposal to prevent fire, heat generation caused by short circuit.

### In the European Union

The crossed-out trash can symbol indicates that all types of batteries must not be discarded in standard trash, or at a trash site. Take the used batteries to a battery collection site according to your national legislation and the Batteries Directive 2006/66/EU.

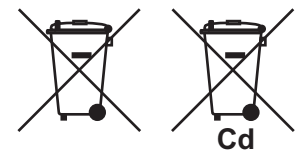

### In the USA

The Mobius loop symbol (three chasing arrows) indicates that Ni-Cd and lead-acid rechargeable batteries must be recycled. Take the used batteries to a battery collection site according to local laws.

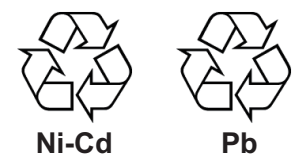



### In the other countries

There are no international standards for the battery recycle symbol. The number of symbols can increase when the other countries make their own recycle symbols in the future.

















# SAFETY INSTRUCTIONS

The operator and installer must read the applicable safety instructions before attempting to operate or install the equipment.

 <b>WARNING</b>	Indicates a potentially hazardous situation which, if not avoided, could result in death or serious injury.
 <b>CAUTION</b>	Indicates a potentially hazardous situation which, if not avoided, may result in minor or moderate injury.

 Warning, Caution	 Prohibitive Action	 Mandatory Action
--	--	--

 <b>WARNING</b>	
	<b>Do not open the equipment unless totally familiar with electrical circuits.</b> Only qualified personnel can work inside the equipment.
	<b>Do not disassemble or modify the equipment.</b> Fire, electrical shock or serious injury can occur.
	<b>Turn the power off before beginning the installation.</b> Be sure both the system and all external devices are turned off. Sudden surge of power could damage the equipment.
	<b>Be sure to power each unit with proper voltage.</b> Connection of an improper power supply can cause fire or damage the equipment.
	<b>Turn the power off immediately if the equipment is emitting smoke or fire.</b> Fire or electrical shock can result if the power is left on.
	<b>Turn off the power immediately if you feel the equipment is acting abnormally.</b> If the equipment is hot to touch or is emitting strange noises, turn the power off immediately and contact your dealer for advice.
	<b>Turn the system off before cleaning and doing maintenance.</b>

 <b>WARNING</b>							
	<b>The mounting location must satisfy the operating temperature range of the equipment.</b>						
	<b>Do not install the equipment where it may get wet from rain or water splash.</b> Water can cause fire or electrical shock, or damage the equipment.						
	<b>Do not operate the equipment with wet hands.</b> Electrical shock can result.						
 <b>CAUTION</b>							
	<b>Do not depend on one navigation device for the navigation of the vessel.</b> Always check your position against all available aids to navigation, for the safety of vessel and crew.						
	<b>Do not connect/disconnect a cable from the main PC while turning the power on.</b>						
<b>Observe the following compass safe distances to prevent deviation of a magnetic compass:</b>							
	<table border="1"> <thead> <tr> <th></th> <th>Standard compass</th> <th>Steering compass</th> </tr> </thead> <tbody> <tr> <td>Sensor Adapter (MC-3000S)</td> <td>2.05 m</td> <td>1.35 m</td> </tr> </tbody> </table>		Standard compass	Steering compass	Sensor Adapter (MC-3000S)	2.05 m	1.35 m
	Standard compass	Steering compass					
Sensor Adapter (MC-3000S)	2.05 m	1.35 m					

# TABLE OF CONTENTS

---

<b>FOREWORD</b> .....	<b>v</b>
<b>SYSTEM CONFIGURATION</b> .....	<b>vi</b>
<b>EQUIPMENT LIST</b> .....	<b>x</b>
<b>1. OPERATION</b> .....	<b>1-1</b>
1.1 What is AR Navigation System?.....	1-1
1.2 Controls Overview .....	1-2
1.3 How to Turn the System On/Off .....	1-2
1.4 Display Overview.....	1-3
1.5 TVI (Top View Indicator).....	1-5
1.6 How to Change the Base Color.....	1-6
1.7 How to Set the CPA and TCPA Thresholds .....	1-7
1.8 How to Customize the Graphics Object.....	1-7
1.8.1 How to show/hide the azimuth scale .....	1-7
1.8.2 How to show/hide the heading guide .....	1-8
1.8.3 How to show/hide the horizon line.....	1-8
1.8.4 How to customize the grid lines.....	1-9
1.8.5 How to show/hide the target shape .....	1-10
1.8.6 How to customize target information .....	1-10
1.8.7 How to customize the route display.....	1-12
1.8.8 How to show/hide the waypoint information .....	1-13
1.8.9 How to show/hide the ENC chart objects .....	1-13
1.9 User Charts .....	1-14
1.9.1 How to share user charts with ECDIS via LAN .....	1-14
1.9.2 How to import user charts exported from the ECDIS .....	1-15
1.9.3 How to adjust area object transparency .....	1-17
1.9.4 How to customize no-go area objects .....	1-17
1.9.5 How to adjust the text size for label objects .....	1-18
1.10 UKHO Charts (Current/Tide Information) .....	1-18
1.10.1 How to activate the UKHO charts display function.....	1-20
1.10.2 How to show/hide user charts .....	1-21
1.10.3 How to set the current information .....	1-21
1.10.4 How to set the tide information.....	1-21
1.10.5 How to deactivate the UKHO charts display function.....	1-22
1.11 How to Select Time Format, Set Local Time .....	1-23
1.12 How to Adjust the Video Image Brilliance.....	1-24
1.13 How to Adjust the Video Image Position .....	1-24
1.14 Screenshots.....	1-27
1.14.1 How to take a screenshot.....	1-27
1.14.2 How to copy screenshots to a USB flash memory .....	1-27
1.14.3 How to delete screenshot files .....	1-29
<b>2. INSTALLATION AND INITIAL SETTINGS</b> .....	<b>2-1</b>
2.1 Mounting.....	2-1
2.1.1 Main PC.....	2-1
2.1.2 PoE adapter .....	2-2
2.1.3 IP camera .....	2-2
2.1.4 Trackball.....	2-3
2.1.5 Sensor adapter (option).....	2-3
2.2 Wiring .....	2-5
2.2.1 Main PC.....	2-5

## TABLE OF CONTENTS

2.2.2	PoE adapter .....	2-7
2.2.3	IP camera .....	2-8
2.2.4	Sensor adapter (option) .....	2-9
2.3	Initial Settings .....	2-17
2.3.1	How to login as a service technician .....	2-17
2.3.2	Initial settings for the IP camera .....	2-18
2.3.3	How to setup the CCRP .....	2-18
2.3.4	How to setup the bow position .....	2-19
2.3.5	How to select the network connected with AR navigation system .....	2-20
2.3.6	How to setup the data source for the position data .....	2-20
2.3.7	How to setup the data source for the heading data .....	2-21
2.3.8	How to setup the data source for the pitch/roll data .....	2-21
2.3.9	How to setup the data source for the TT data .....	2-21
2.3.10	How to enter the IP address of the route server .....	2-23
2.3.11	How to enter the IP address of the ENC chart server .....	2-23
2.3.12	How to enter the IP address of the user chart server .....	2-24
2.3.13	How to enter the IP address and port number of the UKHO chart server .....	2-24
2.3.14	Settings for connected equipment .....	2-25
2.3.15	MC-3000S settings .....	2-26
2.3.16	Service gateway settings .....	2-32
2.4	Operation Check .....	2-34
<b>3.</b>	<b>MAINTENANCE .....</b>	<b>3-1</b>
3.1	Service and Repair .....	3-1
3.2	Warranty Period .....	3-1
3.3	Recommended Replacement Period .....	3-1
3.4	Troubleshooting .....	3-2
3.5	Error Code/Error Message .....	3-3
3.6	How to Restore Default Settings .....	3-9
3.7	System Information .....	3-10
3.7.1	How to show the system information .....	3-10
3.7.2	Sentence monitor window .....	3-11
3.8	How to Perform the Virus Scan .....	3-11
3.9	How to Update the AR Navigation System Application .....	3-12
3.10	How to Update Virus Definition .....	3-13
3.11	How to Update the Operating System .....	3-15
3.12	How to Copy Log Files .....	3-16
3.13	Configuration File .....	3-17
3.13.1	How to export the current configuration file to a USB flash memory .....	3-17
3.13.2	How to import a configuration file .....	3-18
3.14	How to Show Software Information .....	3-20
<b>APPX. 1</b>	<b>MENU TREE .....</b>	<b>AP-1</b>
<b>APPX. 2</b>	<b>ROD TERMINALS .....</b>	<b>AP-4</b>
<b>SPECIFICATIONS .....</b>		<b>SP-1</b>
<b>PACKING LISTS .....</b>		<b>A-1</b>
<b>OUTLINE DRAWINGS .....</b>		<b>D-1</b>
<b>INTERCONNECTION DIAGRAMS .....</b>		<b>S-1</b>
<b>INDEX .....</b>		<b>IN-1</b>

# FOREWORD

---

Congratulations on your choice of the FURUNO AR-100M AR Navigation System. We are confident you will see why the FURUNO name has become synonymous with quality and reliability.

Since 1948, FURUNO Electric Company has enjoyed an enviable reputation for quality marine electronics equipment. This dedication to excellence is furthered by our extensive global network of agents and dealers.

This equipment is designed and constructed to meet the rigorous demands of the marine environment. However, no machine can perform its intended function unless operated and maintained properly. Please carefully read and follow the recommended procedures for operation and maintenance.

We would appreciate hearing from you, the end-user, about whether we are achieving our goal. Thank you for considering and purchasing FURUNO equipment.

## **Cyber Security Notes**

Keep in mind the following points to protect the AR navigation system from viruses.

- The AR navigation system is equipped with anti-virus software. The virus definitions and related files must be kept up-to-date. The operator is solely responsible for updating the virus definition. For how to update the virus definitions, see section 3.10.
- The PC and USB flash memory used to download and store an update file (for user chart file, virus definition, etc.) may be infected with a virus. Check the PC and the USB flash memory for viruses with a virus checker BEFORE you connect the USB flash memory to the AR navigation system.
- The main PC must be located in a high physical security area.
- DO NOT connect the AR navigation system and HUB-3000 to an external network, including other shipborne LAN.

## **CE/UKCA declaration**

With regards to CE/UKCA declarations, please refer to our website ([www.furuno.com](http://www.furuno.com)), for further information on RoHS conformity declarations.

# SYSTEM CONFIGURATION

**FMD-3200/3300 is included in the system configuration**

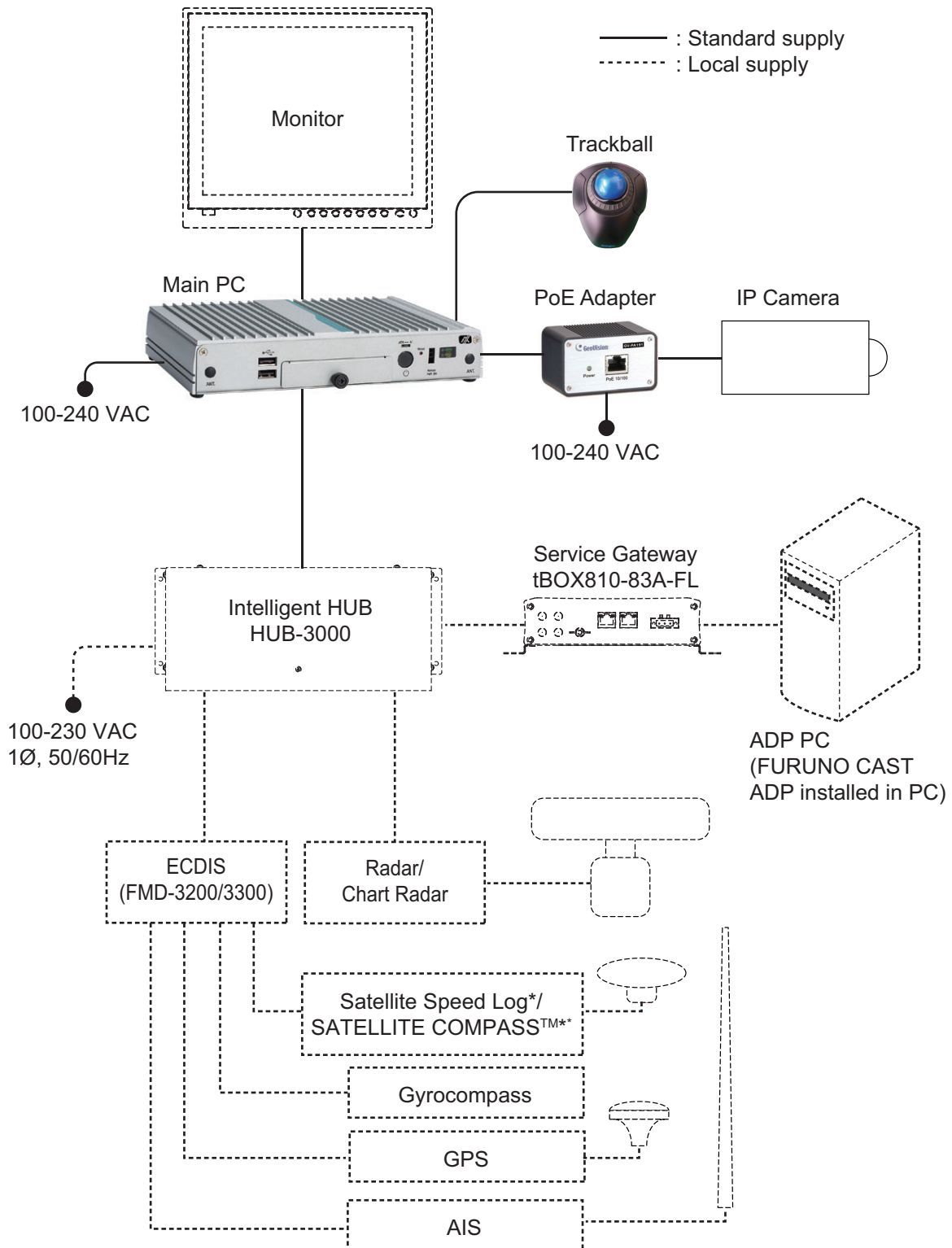

\*: Performance after corrections to pitch, roll and yaw errors may vary, depending on the specifications of the connected equipment.

**FMD-3100 is included in the system configuration**

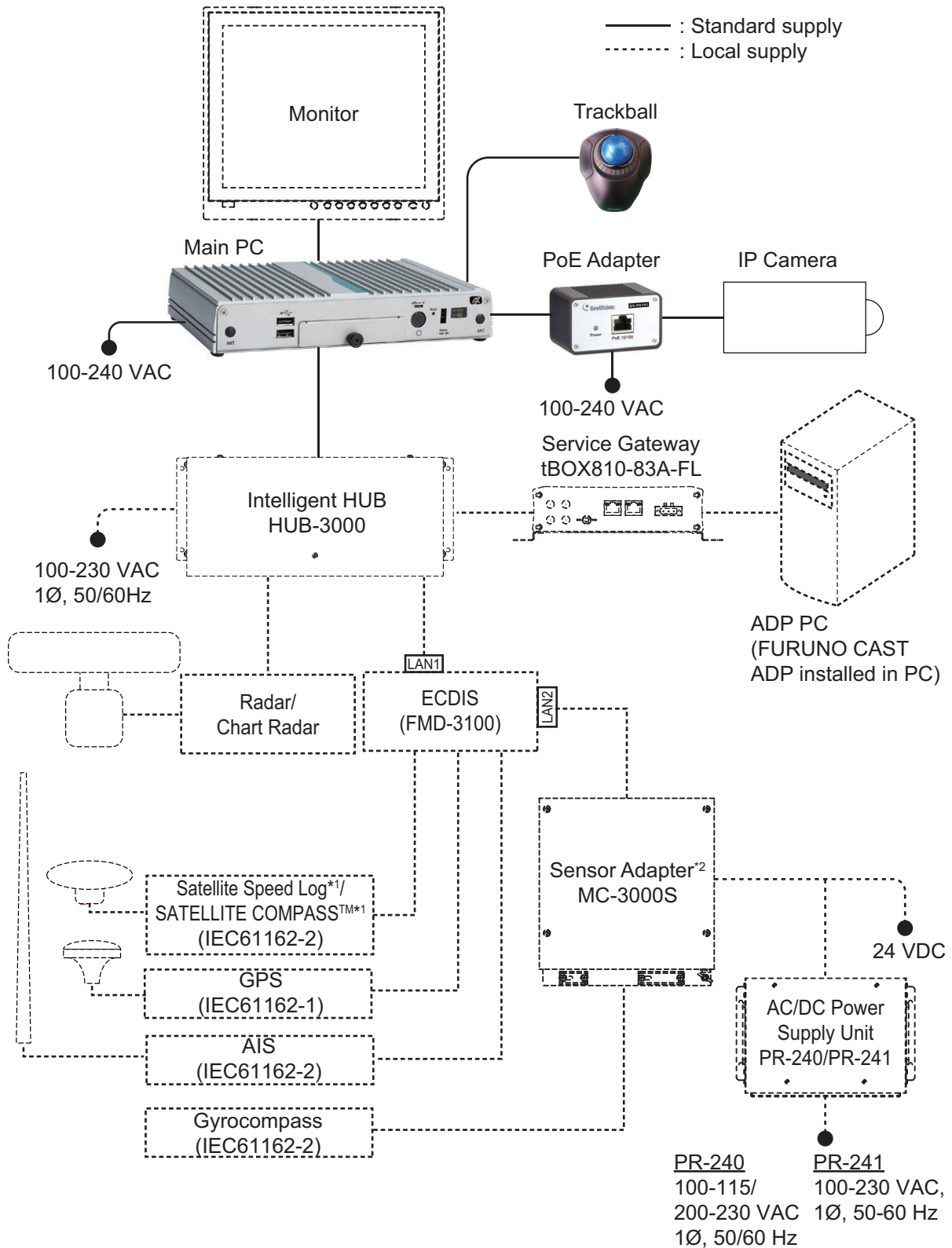

\*1: Performance after corrections to pitch, roll and yaw errors may vary, depending on the specifications of the connected equipment.

\*2: A maximum of two IEC61162-2 signals can be connected to FMD-3100. If it is required to connect AIS, gyrocompass and satellite speed log/SATELLITE COMPASS™ with the IEC61162-2 format, use MC-3000S.

**The ECDIS is not included in the system configuration**

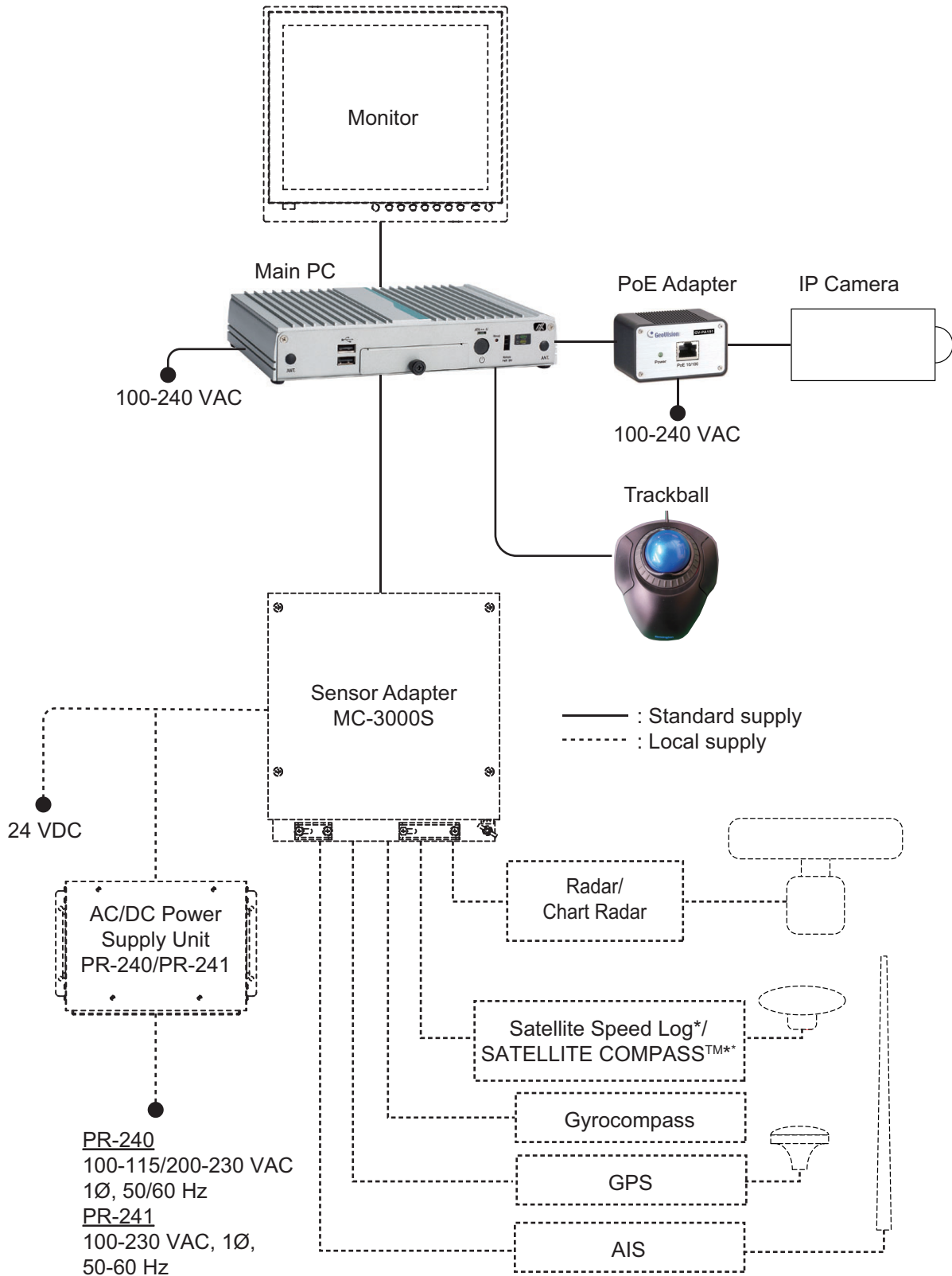

\*: Performance after corrections to pitch, roll and yaw errors may vary, depending on the specifications of the connected equipment.



**Compatible equipment**

Category	Model	Route Sharing	ENC Chart Sharing	User Chart Sharing
ECDIS	FMD-3200/3300	✓	✓	✓
	FMD-3100	✓	✓	✓

Category	Model	Connect through...	
		ECDIS	MC-300S
Radar	FAR-14×7	-	✓
	FAR-15×8	✓	✓
	FAR-2××7	✓	✓
	FAR-2××8	✓	✓
Chart Radar	FAR-3000	✓	✓
SATELLITE COMPASS™	SC-30	✓	✓
	SC-33	✓	✓
	SC-50	✓	✓
	SC-70	✓	✓
	SC-110	✓	✓
	SC-130	✓	✓
	SCX-21	✓	✓
Satellite Speed Log	GS-100	✓	✓
AIS	FA-30	✓	✓
	FA-40	✓	✓
	FA-50	✓	✓
	FA-60	✓	✓
	FA-70	✓	✓
	FA-150	✓	✓
	FA-170	✓	✓
GPS	GP-33	✓	✓
	GP-39	✓	✓
	GP-150	✓	✓
	GP-170	✓	✓
	GP-3500/F	✓	✓
	GP-3700/F	✓	✓
UKHO chart device	ADP PC	✓	-
	tBOX810-83A-FL (Service gateway)	✓	-

# EQUIPMENT LIST

## Standard supply

Name	Type	Code No.	Qty	Remarks
Main PC (Fanless Box PC)	eBOX100-312-FL- N3350	-	1	With AC adapter (3 m) and mounting kit
IP Camera	GV-EBX2100	-	1	
PoE Adapter	GV-PA191	-	1	With AC adapter (1.8 m)
Trackball	K72337JP	-	1	With 1.5 m USB cable
ENC Dongle*	ENC-KEY	-	1	
HDMI Cable	DH-HD14E50/RS	000-197-075-10	1	10 m cable between main PC and monitor
LAN Cable	P5E-4PTX-BL L=10M	000-164-637-10	2	10 m cable between: • HUB-3000 and main PC • IP camera and PoE adapter
	P5E-4PTX-BL L=2M	000-164-634-10	1	2 m cable between PoE adapt- er and main PC
USB Cable	KU-EN5K	000-197-073-10	2	5 m cable between: • USB flash memory and main PC • Trackball and main PC
Bracket	TB-109	000-197-072-10	1	For installing IP camera
Adhesive Mat	TR-GM20-TM	000-199-553-10	1	For installing PoE adapter

\*: Supplied for the configuration connecting with the ECDIS.

## Option

Name	Type	Code No.	Remarks
Sensor Adapter	MC-3000S	-	
AC/DC Power Supply Unit	PR-240	-	
	PR-241	-	
Marine Box PC (Service Gateway)	tBOX810-83A-FL	-	
LAN Cable	FR-FTPC-CY *10M*	001-240-510	10m
	FR-FTPC-CY *20M*	001-240-520	20m
	FR-FTPC-CY *30M*	001-240-530	30m
Crimping Tool	CRIMPFOX10S	001-206-920	For ferrule
FURUNO CAST ADP	OP03-271	001-630-790	Required to display UKHO charts.

# 1. OPERATION

## 1.1 What is AR Navigation System?

The AR (Augmented Reality) navigation system is designed to assist in collision avoidance and increase safety of life at sea by giving the operator an increased level of situational awareness around the vessel.

The AR navigation system can overlay the following navigation data on the actual video image in front of a vessel captured by the IP camera.

- Azimuth information from gyrocompass
- AIS data from AIS transponder
- TT data from radar
- Route, To waypoint, user chart and ENC chart symbols from ECDIS
- UKHO charts from the ADP PC (The FURUNO CAST ADP (option software) must be installed in the ADP PC.)

The system keeps the AR objects aligned with the actual targets, compensating for roll, pitch and yaw.

For the video introducing the AR-100M, scan to visit our YouTube channel. 

For the video of the AR stabilization, scan to visit our YouTube channel. 

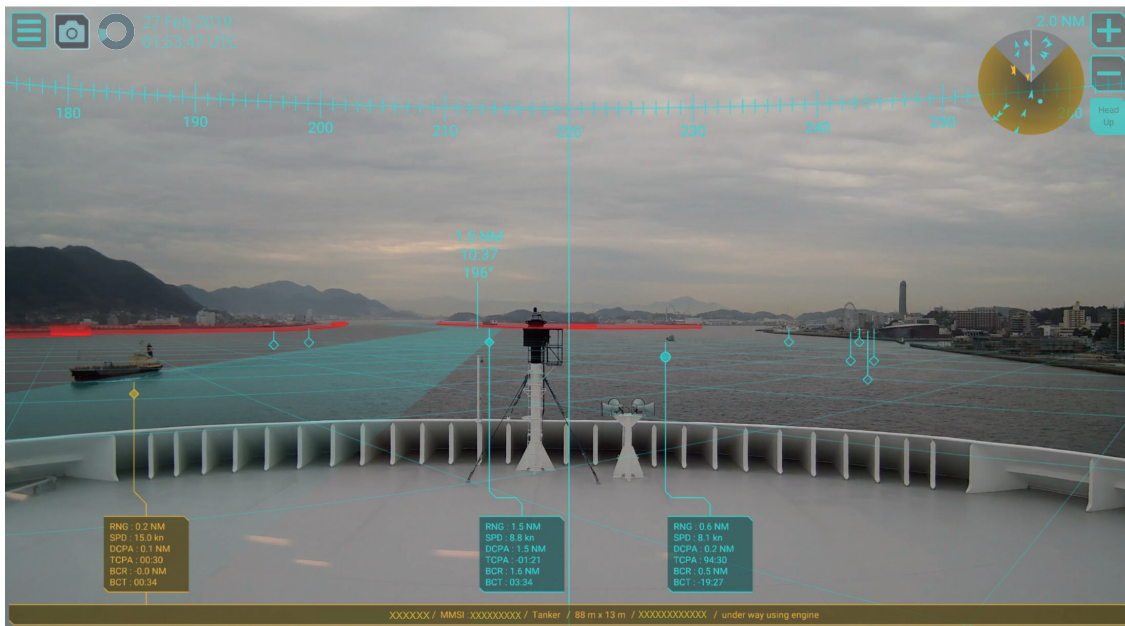

Display example for the AR navigation system

**Note 1:** Do not solely rely on the AR navigation system to navigate the vessel. Always check your position against all available aids to navigation, for the safety of vessel and crew.

**Note 2:** An ENC dongle is necessary to share the ENC charts from the ECDIS. Keep the ENC dongle connected to one of the USB ports on the main PC while using the AR navigation system.

## 1.2 Controls Overview

You can control almost all aspects of your AR navigation system from the trackball. The figure to the right and the table below show an overview of the trackball with a brief description of the controls.

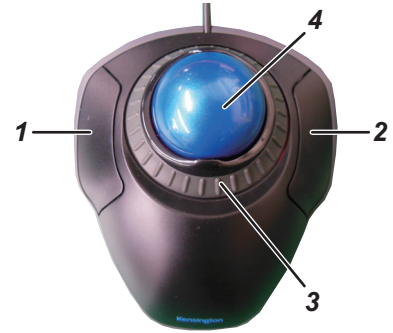

No.	Name	Description
1	Left button	Select a highlighted object or menu item.
2	Right button	No function.
3	Scroll ring	<ul style="list-style-type: none"> <li>• Scrolls the menu.</li> <li>• Zooms in/out at cursor location.</li> </ul>
4	Trackball	Moves the cursor.

### Standards used in this manual

Unless noted otherwise, “click” means to put the cursor on a object and press the left button on the trackball.

## 1.3 How to Turn the System On/Off

The power button for the system is located on the front panel of the main PC.



**Note:** When you turn the system on/off, keep in mind the following points:

- Supply power to the IP camera BEFORE turning on the AR navigation system. The video image may not appear if the IP camera is not powered first. If the video image does not appear, restart the AR navigation system.
- Lightly press the power button. If the power button is pressed too firmly, the button may get caught on the chassis.
- Do not turn the system off at the switchboard or breaker. The unit may be damaged.

### How to turn the system on

To turn the system on, press the power button. After pressing the power button, the LED on the main PC lights up and the system begins its startup process. When the startup process is completed, the following message appears. Confirm the message, then click the [OK] button to close the message.

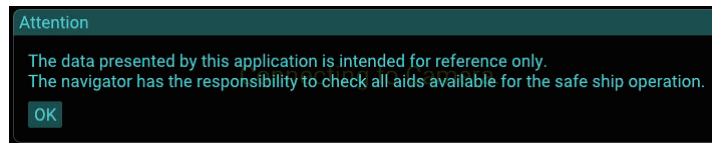

When connecting to the IP camera, the following message appears at the center of the screen. Connecting process can take up to approximately one minute. After connecting with the IP camera, the AR navigation system screen appears automatically on the display.

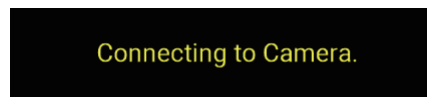

**Note:** When the user chart file has been imported, the message shown in the figure to the right appears. For how to import the user chart file, see subsection 1.9.2.

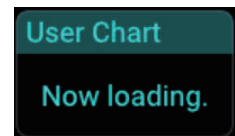

### How to turn the system off



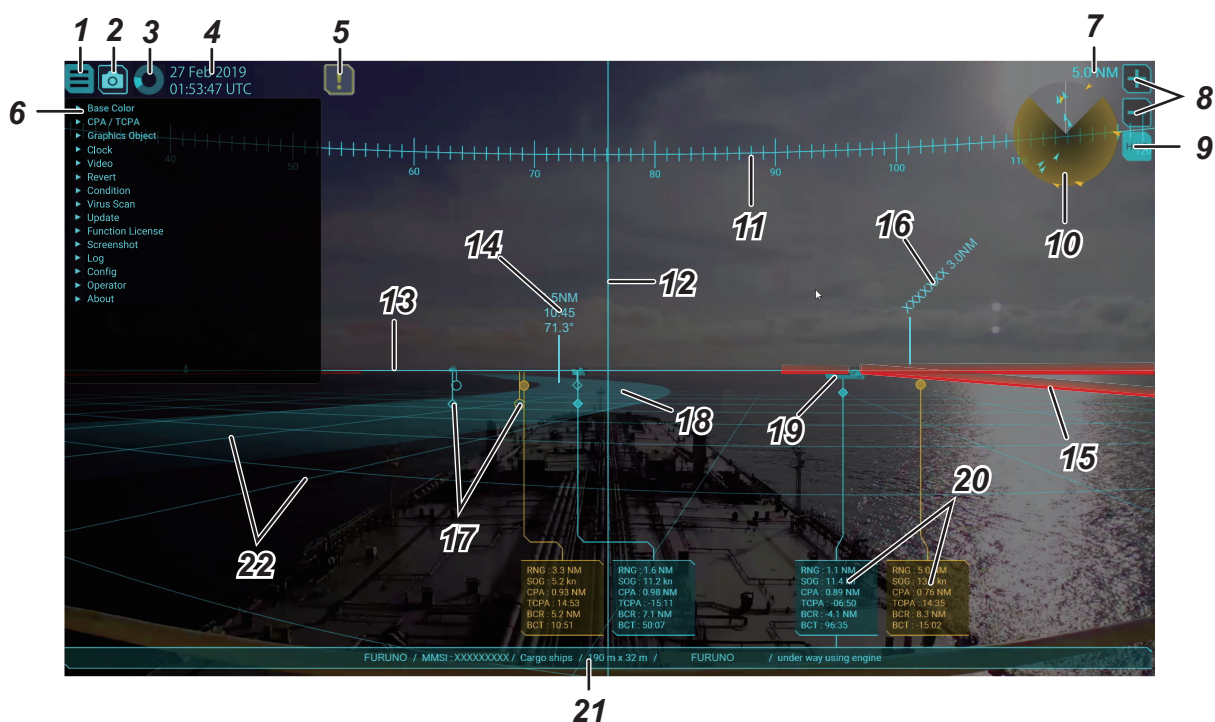

To turn the system off, press the power button again.

## 1.4 Display Overview



No.	Name	Description
1	Menu button	Opens/closes the main menu.
2	Screenshot button	Takes a screenshot of the current display.

1. OPERATION

No.	Name	Description
3	Working indicator	Rotates clockwise when the system is working correctly. Stops rotating when the system is frozen or malfunctioning.
4	Time and date	Displays the current time and date. You can select the time to use, local or UTC. See section 1.11.
5	Error button	Opens/closes the error frame. This button appears only when a minor error occurs. Click the button to open the error frame, then confirm the error message.
6	Main menu	The main menu contains customizing options for this equipment. To open/close the menu, click the menu button. You can also close the main menu by clicking the video image.
7	Range	Shows the current display range in use for the AR navigation system.
8	Range control button	Adjusts the display range in use for the AR navigation system. The symbols on the AR navigation screen and TVI (Top View Indicator) change according to the display range. Click the  button to increase the range, or click the  button to reduce the range.
9	TVI Presentation mode button	<p>Toggles between head-up and north-up presentation modes for the TVI. The indication on the button changes according to the presentation mode.</p> <div style="display: flex; align-items: center; justify-content: center;">  <span style="margin: 0 10px;">← Click →</span>  </div> <ul style="list-style-type: none"> <li>• [H-UP] (Head Up): Displays the symbols with the heading line of own ship at the top of the TVI. The heading line and the direction of the field of view are fixed, and the symbols rotate according to the heading.</li> <li>• [N-UP] (North Up): True north (0°) is at the top of the TVI. The heading line and the direction of the field of view rotate according to the heading.</li> </ul>
10	TVI (Top View Indicator)	Displays the TT and AIS target's location in a circle about own ship. For details, see section 1.5.
11	Azimuth scale	Provides an estimate of the bearing to a target.
12	Heading guide	You can estimate the heading of own ship, by reading the point at which the heading guide intersects the azimuth scale. <b>Note:</b> When the IP camera position is offset from the ship's center, the heading guide is not aligned with the ship's bow on the video image.
13	Horizon line	Indicates the horizon, and is used to adjust the video image position. Normally, hide the horizon line. For how to show/hide the horizon line, see subsection 1.8.3.
14	Waypoint information	Display the information (course to the next waypoint, time to go, distance) for the To waypoint on the route.
15	No-go area	Indicates the area where the vessel is not allowed to go. You can show or hide the visible wall for the no-go area. See subsection 1.9.4. When you hide the visible wall, the no-go area is drawn only with a line.
16	User chart label	Indicates the user chart input from ECDIS.
17	Selective marker	<p>Click the marker to show the TT or AIS target information. The figure below shows the appearance of the AIS and TT symbols.</p> <div style="text-align: center;"> <p>AIS symbol                      TT symbol</p> <p>Unselected   Selected   Unselected   Selected</p> </div> <p>When a AIS or TT target is evaluated to be an attentional target, its symbol is shown in the designated color (yellow, orange or red). For how to change the color, see section 1.7.</p>

No.	Name	Description
18	Route leg	Shows the monitored route leg that is shared with the ECDIS.
19	Target shape	The target shape function overlays a ship graphic and buoy graphic on respective AIS targets and buoys. This is useful when AIS targets and buoys are not visible to the eye because of darkness or fog. For how to show/hide the target shape, see subsection 1.8.5.
20	Main target information frame	Shows navigation information for the target chosen with the selective marker. To close the frame, click the selective marker again to deselect the marker. You can customize the information to be shown in the frame. See subsection 1.8.6
21	Appended target information frame	Click the main target information frame to show the appended target information frame. To close the frame, click the main target information frame again. You can customize the information to be shown in the frame. See subsection 1.8.6.
22	Grid	Grid lines can be shown on the display, and are available in two types. <ul style="list-style-type: none"> <li>• [Own]: Shows the grid lines based on the current IP camera position. Grid lines are fixed.</li> <li>• [World]: Shows the grid lines based on the IP camera position when the AR-100M application is started. Grid lines move according to the ship's movement.</li> </ul> For how to change the mode or hide the grid, see subsection 1.8.4.

## 1.5 TVI (Top View Indicator)

The TVI displays the TT and AIS target's location in a circle about own ship. The field of view on the AR navigation system is filled in gray. The area out of the field of view is filled in black. When you zoom in/out the screen (by the scroll ring), the field of view on the TVI also changes.

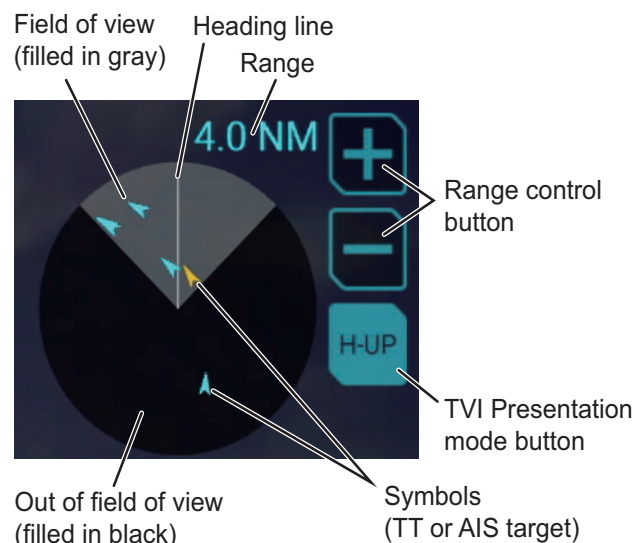

The AIS or TT target that is within the range of the CPA/TCPA threshold is shown in the designated color (yellow, orange or red). If there is an attentional target in the out of field of view area, the area flashes in the designated color. The color can be changed from the menu. See section 1.7.



For the attentional target indication in the out-of-view area, scan to visit our YouTube channel.



**Range control**

You can adjust the display range for the AR navigation system from the range control button. The symbols on the AR navigation screen and TVI change according to the display range. Click the  button to increase the range, or click the  button to reduce the range.

For the change of the AR navigation screen due to the range switching, scan to visit our YouTube channel.



**Presentation mode**

To change the presentation mode, click the TVI presentation mode button at the top right of the screen.

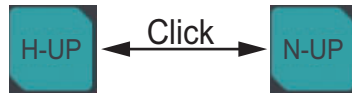





The following presentation modes are available with the TVI:

- [H-UP] (Head Up): Displays the symbols with the heading line of own ship at the top of the TVI. The heading line and the direction of the field of view are fixed, and the symbols rotate according to the heading.
- [N-UP] (North Up): True north (0°) is at the top of the TVI. The heading line and the direction of the field of view rotate according to the heading.

**Symbols**

The following table shows the symbols used in the TVI.

	Without HDG/COG	With HDG/COG
AIS		 (HDG > COG)
TT		 (COG)

**Note 1:** The normal target color depends on the base color setting. See section 1.6.

**Note 2:** The attentional target color can be changed from the menu. See section 1.7.

## 1.6 How to Change the Base Color

You can change the base color for the AR navigation system screen. The base color is applied to the following items:

- Main menu text and buttons
- Target information text and frame\*
- Grid
- Symbols\* and buttons for TVI
- ENC chart (other than safety contour)
- Waypoint text
- Route leg
- Screenshot button
- Working indicator
- Heading guide
- User chart (other than no-go area)
- Horizon line
- Azimuth scale
- Target shape\*
- UKHO chart

\*: Does not include attentional targets.



1. Click the menu button to open the main menu.
2. Click [Base Color].
3. Click an appropriate checkbox to select the base color.
4. Close the main menu.

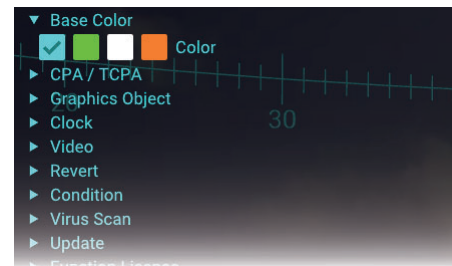

## 1.7 How to Set the CPA and TCPA Thresholds

The AR navigation system continuously monitors the predicted range at the Closest Point of Approach (CPA) and predicted time to CPA (TCPA) of each AIS and TT target. When the predicted CPA of any AIS or TT becomes smaller than the preset CPA threshold and its predicted TCPA less than the preset TCPA threshold, the symbol and target information color are changed to the designated color (yellow, orange or red).

1. Click the menu button to open the main menu.
2. Click [CPA/TCPA].
3. Adjust the slider bar for [CPA Threshold] to change the CPA threshold.
4. Adjust the slider bar for [TCPA Threshold] to change the TCPA threshold.
5. Click an appropriate checkbox of [Attentional Color] to select the color for the attentional target.
6. Close the main menu.

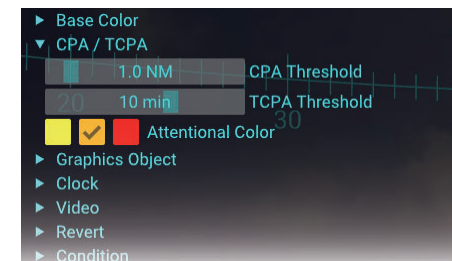

## 1.8 How to Customize the Graphics Object

### 1.8.1 How to show/hide the azimuth scale

The azimuth scale is shown at the top of the screen. You can use the scale to estimate the bearing of ship's heading or a target. The azimuth scale rotates according to the ship's movement.

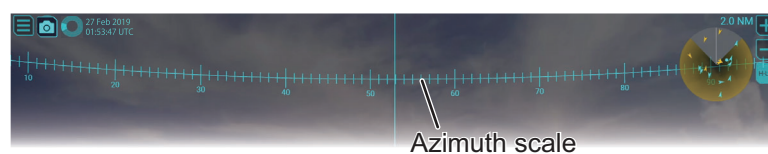

## 1. OPERATION

1. Click the menu button to open the main menu.
2. Click [Graphics Object].
3. Click [Azimuth Scale].
4. Check the checkbox for [Visible] to show the azimuth scale. If you want to hide the scale, remove the check mark from the checkbox.
5. Adjust the slider bar for [Text Scale] to change the size of the text on the azimuth scale.
6. Close the main menu.

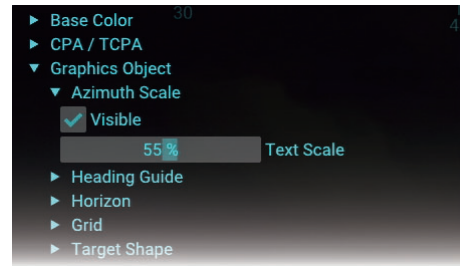

### 1.8.2 How to show/hide the heading guide

You can estimate the heading of own ship, by reading the point at which the heading guide intersects the azimuth scale.

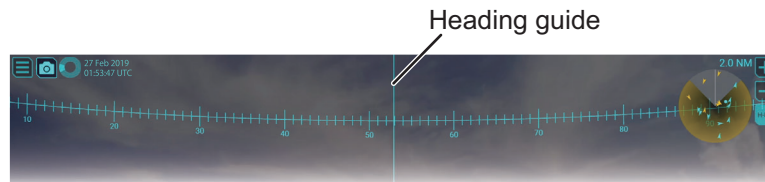

1. Click the menu button to open the main menu.
2. Click [Graphics Object].
3. Click [Heading Guide].
4. Check the checkbox for [Visible] to show the heading guide. If you want to hide the heading guide, remove the check mark from the checkbox.
5. Close the main menu.

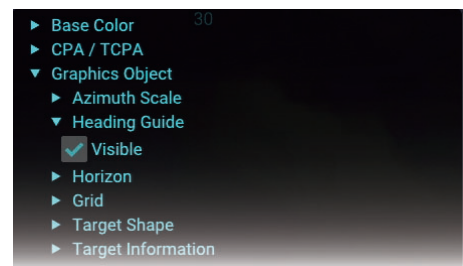

### 1.8.3 How to show/hide the horizon line

You can show the horizon line on the AR navigation system. If the horizon line is not aligned with the horizon on the screen, adjust the position of the video image. See section 1.13.

**Note:** The horizon line is used to adjust the video image position. Normally, hide the horizon line.



1. Click the menu button to open the main menu.
2. Click [Graphics Object].
3. Click [Horizon].
4. Check the checkbox for [Visible] to show the horizon line. If you want to hide horizon line, remove the check mark from the checkbox.
5. Close the main menu.

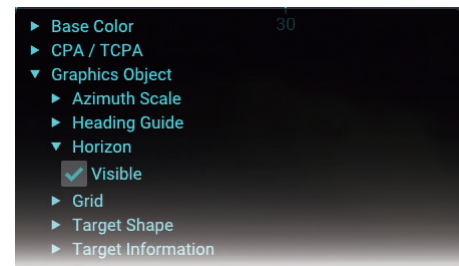

## 1.8.4 How to customize the grid lines

Grid lines can be shown in one of two methods.

- [Own]: Shows the grid lines based on the current IP camera position. Grid lines are fixed.
- [World]: Shows the grid lines based on the IP camera position when the AR-100M application is started. Grid lines move according to the ship's movement.

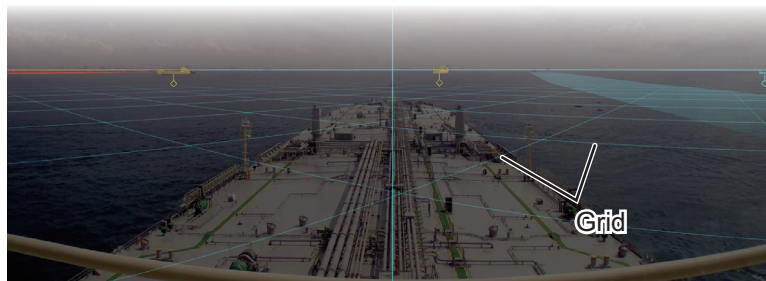

Also, you can customize the grid pitch, number of grid cells and the transparency of the grid lines.

1. Click the menu button to open the main menu.
2. Click [Graphics Object].
3. Click [Grid].
4. Check the checkbox for [Visible] to show the grid. If you want to hide the grid, remove the check mark from the checkbox.
5. Check the radio button for [World] or [Own].
6. Adjust the slider bar for [Pitch], [Extension] and [Density] as appropriate.
  - [Pitch]: Adjust the pitch for the grid lines.
  - [Extension]: Adjust the number of the grid cells.
  - [Density]: Adjust the transparency of the grid lines.
7. Close the main menu.

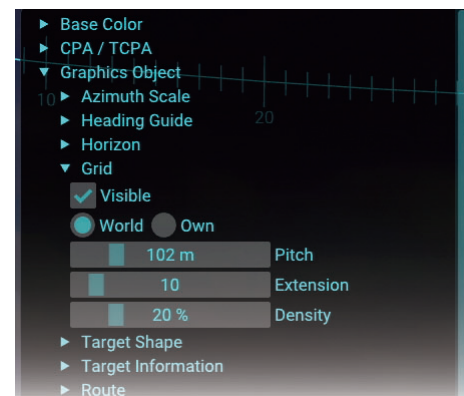

# 1. OPERATION

## 1.8.5 How to show/hide the target shape

You can overlay the applicable target shape (graphic) on AIS targets and buoys. This feature is useful for showing the AIS targets and buoys on the screen that are not completely visible because of darkness or fog.

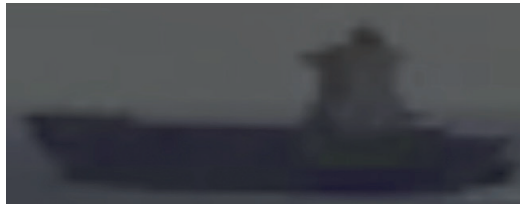

Target shape = OFF

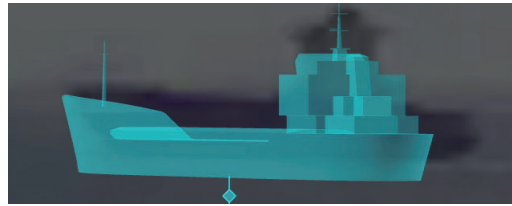

Target shape = ON

The AR navigation system overlays the following target shapes according to the target size and type.



Buoy/Virtual buoy

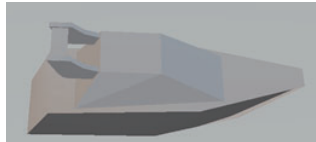

AIS target (boat)



AIS target (tanker)

1. Click the menu button to open the main menu.
2. Click [Graphics Object].
3. Click [Target Shape].
4. Check the checkbox for [Visible] to show the target shape. If you want to hide the target shape, remove the check mark from the checkbox.
5. Close the main menu.

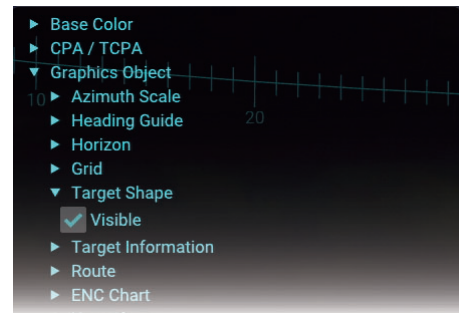

## 1.8.6 How to customize target information

You can customize the contents in the main target information frame and appended target information frame.

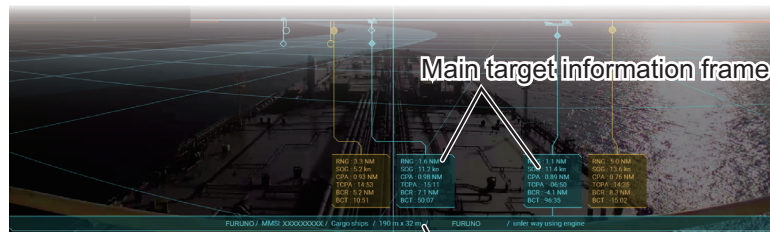

Appended target information frame

1. Click the menu button to open the main menu.
2. Click [Graphics Object].

3. Click [Target Information].

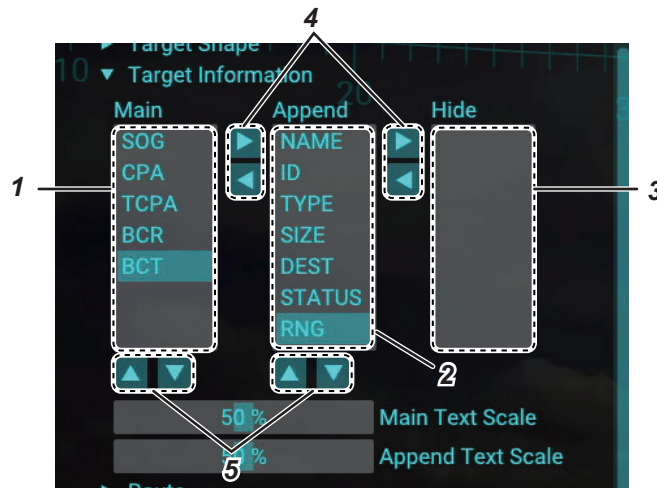

4. Customize the data referring to the following table.

No.	Name	Description
1	[Main] box	Data displayed in the main target information frame.
2	[Append] box	Data displayed in the appended target information frame.
3	[Hide] box	The data registered in the [Hide] box is not shown in either the main or appended target information frames.
4	Frame change button	Moves the data selected with the cursor to other setting box.
5	Order change button	Changes the order of the data selected with the cursor.

#### **Available target data**

The following data is available for the target information:

Item	Description
[NAME]	Vessel name. For targets whose vessel name data is not available, "<No Name>" appears.
[ID]	<ul style="list-style-type: none"> <li>• TT target: When the data source can be specified, radar ID and target ID are shown.</li> <li>• AIS target: MMSI is shown.</li> </ul>
[SIZE]	Vessel size of the AIS target. For the TT target and AIS target whose vessel size data is not available, "---- m × --- m" appears.
[DEST]	Destination (max. 20 characters). For the target whose destination data is not available, "<No Destination>" appears.
[STATUS]	Navigational status for the AIS target. For targets whose navigational data is not available, "<No Navigational Status>" appears.
[TYPE]	Vessel type for the AIS target. For TT/AIS targets whose vessel type data is not available, "<No Type>" appears.
[RNG]	Distance to the target.
[CPA]	Target's CPA.
[TCPA]	Target's TCPA.
[BCR]	Target's bow cross range.
[BCT]	Target's bow cross time.
[SOG]	Target's speed over the ground.

## 1. OPERATION

- Adjust the slider bar for [Main Text Scale] to change the size of the text in the main target information frame.
- Adjust the slider bar for [Append Text Scale] to change the size of the text in the appended target information frame.
- Close the main menu.

### 1.8.7 How to customize the route display

The monitored route can be shown on the AR navigation system screen. The route becomes darker with distance from own ship.

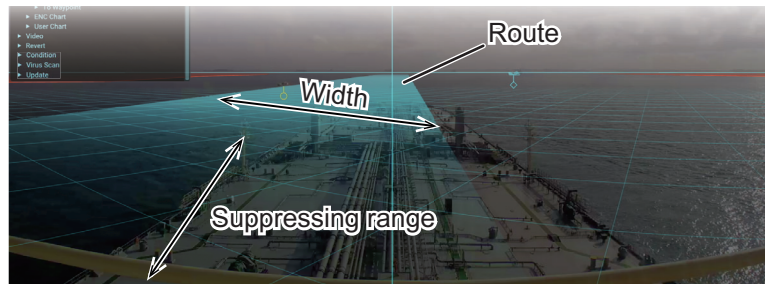

You can customize the width, transparency and suppressing range for the route display.

- Click the menu button to open the main menu.
- Click [Graphics Object].
- Click [Route].
- Click [Leg].
- Check the checkbox for [Visible] to show the route. If you want to hide the route, remove the check mark from the checkbox.
- Adjust the slider bar for [Width], [Suppressing Range] and [Density] as appropriate.
  - [Width]: Adjust the width of the route display, colored base color.
  - [Suppressing Range]: Adjust the range to suppress the transparency of the route display near the vessel. Adjust this value to improve the visibility of the targets near the vessel.
  - [Density]: Adjust the transparency of the route display.
- Close the main menu.

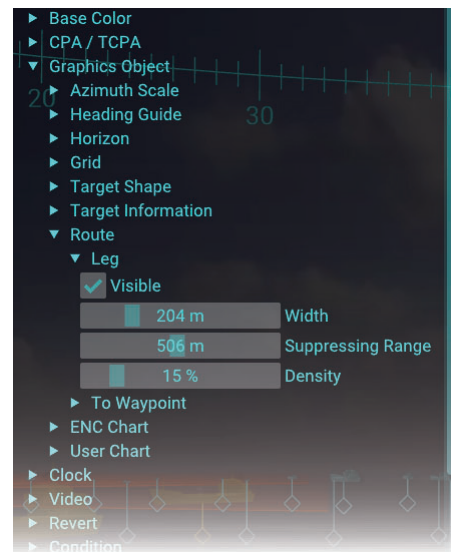

## 1.8.8 How to show/hide the waypoint information

You can show/hide the information (course to the next waypoint, time to go, distance) for the To waypoint on the route.

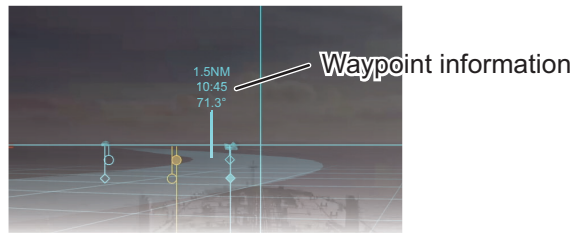

1. Click the menu button to open the main menu.
2. Click [Graphics Object].
3. Click [Route].
4. Click [To Waypoint].
5. Check the checkbox for [Visible] to show the waypoint information. If you want to hide the information, remove the check mark from the checkbox.
6. Adjust the slider bar for [Text Scale] to change the size of the text for the waypoint information.
7. Close the main menu.

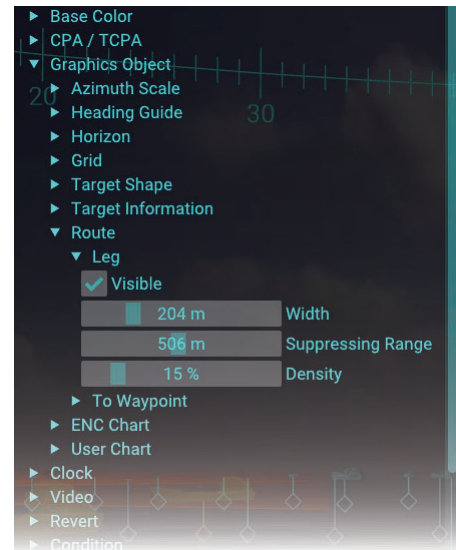

## 1.8.9 How to show/hide the ENC chart objects

The following ENC chart objects can be displayed on the AR navigation system screen:

- Buoy
- Coast line
- Pilot station
- Safety contour\*

\*: The safety contour may or may not be visible depending on the safety contour settings at the ECDIS.

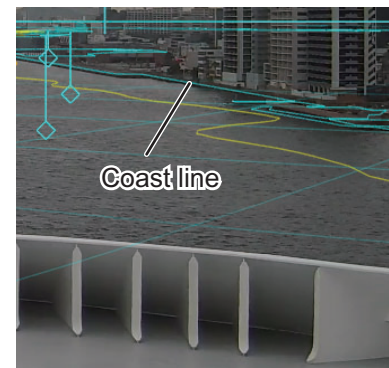
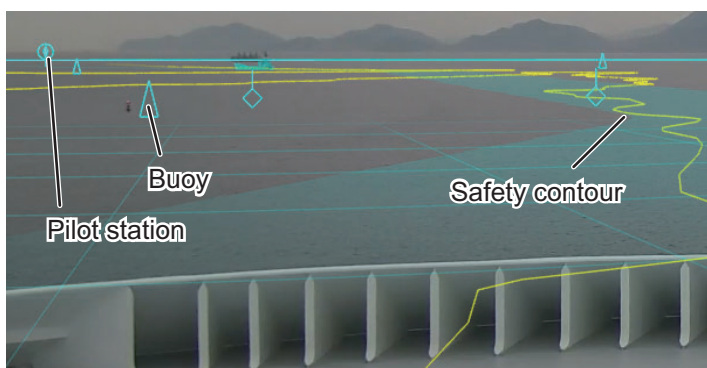

**Note 1:** The AR navigation system cannot overlay ENC chart objects from the ECDIS if the ECDIS has C-MAP charts installed. Uninstall C-MAP charts to use ENC chart objects.

## 1. OPERATION

**Note 2:** The most detailed ENC chart objects at current position are displayed on the AR navigation system. Therefore, ENC chart objects on the AR navigation system may be different from the objects on the ECDIS.

1. Click the menu button to open the main menu.
2. Click [Graphics Object].
3. Click [ENC Chart].
4. Check the checkbox for [Visible] to show the ENC chart objects. If you want to hide the objects, remove the check mark from the checkbox.
5. Click an appropriate checkbox of [Safety Contour Color] to select the color for the safety contour.
6. Close the main menu.



## 1.9 User Charts

User charts are overlays that the user creates to indicate safety-related objects and areas. The AR navigation system can display the user chart objects created on the ECDIS by importing the user chart file or sharing data via LAN network.

**Note:** If there are too many objects in the user chart, the screen may stop temporarily when loading data.

### 1.9.1 How to share user charts with ECDIS via LAN

Do as follows to share user chart data with ECDIS via LAN.

**Note:** When a space character is contained in the user chart name, the data cannot be received via LAN. Therefore, the user chart cannot be displayed.

1. Click the menu button to open the main menu.
2. Click [Graphics Object].
3. Click [User Chart].
4. Check the checkbox for [Visible] to show the user chart objects. If you want to hide the objects, remove the check mark from the checkbox.
5. Activate the [Network] radio button.
6. Close the main menu.

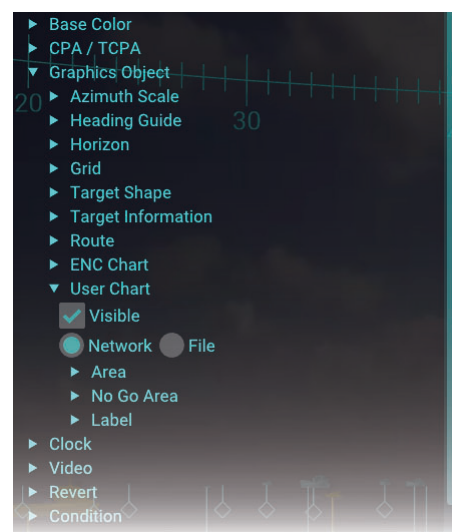



## 1.9.2 How to import user charts exported from the ECDIS

Do as follows to import user charts exported from the ECDIS.

1. Export the user chart (file extension: xml) from the ECDIS to a USB flash memory then insert the flash memory to the USB port on the main PC.  
**Note:** The user chart must be saved to the root directory of the USB flash memory.
2. Click the menu button to open the main menu.
3. Click [Graphics Object].
4. Click [User Chart].
5. Check the checkbox for [Visible] to show the user chart objects. If you want to hide the objects, remove the check mark from the checkbox.
6. Activate the [File] radio button.

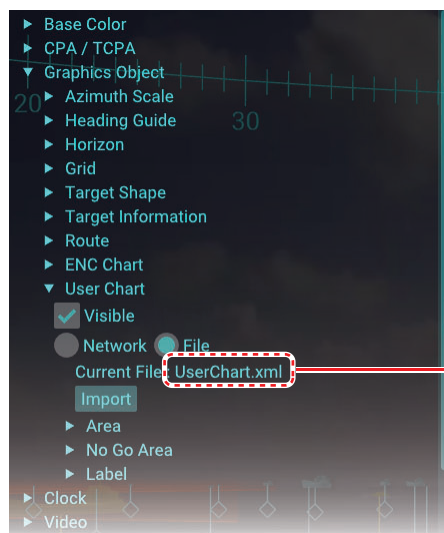

Current user chart file name that is used on the AR navigation system appears here.

7. Click the [Import] button.  
The window as shown in the figure to the right appears.

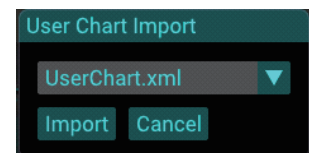

**Note:** If the user chart file is not saved in the USB flash memory, the message shown in the figure to the right appears. Confirm that the user chart file is saved correctly in the flash memory.

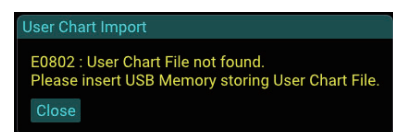

8. Select a user chart file from the drop-down list.  
**Note:** The following characters and symbols are available for the file name. Do not use other characters and symbols.

- Allowed characters: Alphanumeric characters
- Allowed symbols: ! #\* \$ % & ' ( ) + , - . ; = @ [ ] ^ \_ ` { } ~ °  
\*: Multiple same characters (example: ##) cannot be used.

9. Click the [Import] button.  
The confirmation message shown in the figure to the right appears.

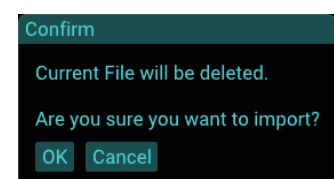

1. OPERATION

10. Click the [OK] button.

The message shown below-left appears during the import. After completing the import, the confirmation message shown below-right appears.

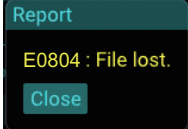
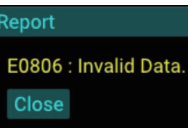
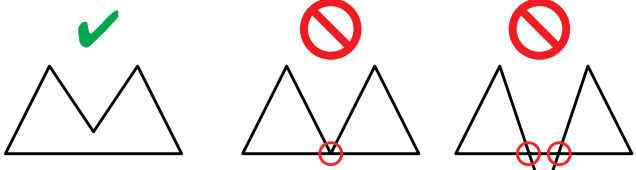
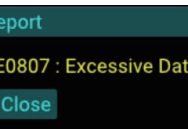
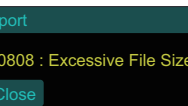

**Note:** If an error message appears while importing a user chart file, see the table below to rectify the error.

Error message	Meaning/Remedy
	<p>The flash memory was removed while importing a user chart file. Close the message and insert the flash memory, then re-try importing the user charts.</p>
	<p>Invalid user chart file is used. Use the user chart file exported from the ECDIS. Also, if the user chart file contains an area type object(s) which has lines that cross or contact one another, the AR-100M cannot import the user chart file.</p> <div style="text-align: center;">  <p>No contact/crossed lines      Contact      Crossed</p> </div>
	<p>There are too many data in the user chart file. Use a user chart file with up to 100,000 vertexes and 10,000 objects.</p> <p><u>Example: User chart data with 10 triangle objects</u></p> <ul style="list-style-type: none"> <li>• Total number of vertexes: 3 vertexes (triangle) × 10 objects = 30 vertexes</li> <li>• Total number of objects: Number of triangle object = 10 objects</li> </ul>
	<p>The capacity of the user char file exceeds 20 MB. Use the user chart file whose capacity is less than 20 MB.</p>

11. Remove the USB flash memory.

12. Click the [Close] button to close the message.

13. Close the main menu.

When the user chart file has be imported, the message shown in the figure to the right appears.

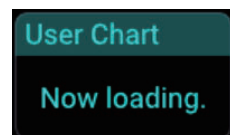

### 1.9.3 How to adjust area object transparency

1. Click the menu button to open the main menu.
2. Click [Graphics Object].
3. Click [User Chart].
4. Click [Area].
5. Adjust the slider bar for [Density] to adjust the transparency of the area object.
6. Close the main menu.

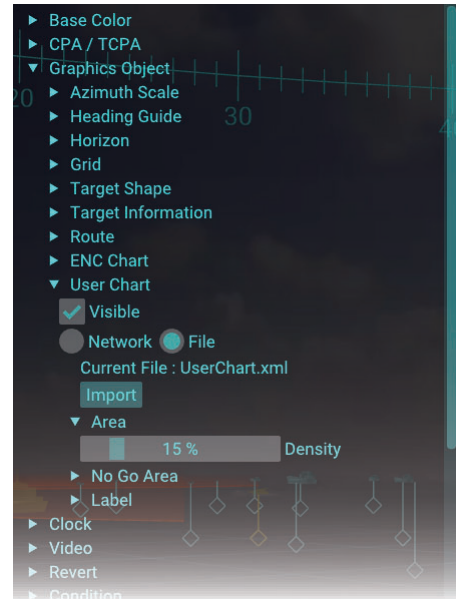

### 1.9.4 How to customize no-go area objects

1. Click the menu button to open the main menu.
2. Click [Graphics Object].
3. Click [User Chart].
4. Click [No Go Area].
5. Select the color for the no-go area objects. The AR navigation system recognizes the user chart objects whose line style is “Coast” or “Depth” as no-go area objects. No-go areas are drawn with the color selected here. The color for other line objects depends on the base color.
6. Check the checkbox for [Visible Wall] to show the visible wall for the no-go area. If you want to hide the visible wall, remove the check mark from the checkbox. When you hide the visible wall, the no-go-area is drawn only with a line.

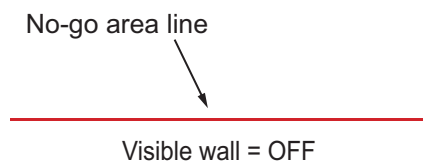
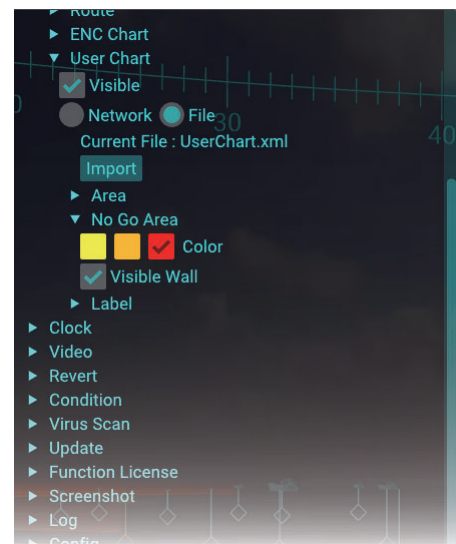

7. Close the main menu.

### 1.9.5 How to adjust the text size for label objects

1. Click the menu button to open the main menu.
2. Click [Graphics Object].
3. Click [User Chart].
4. Click [Label].
5. Adjust the slider bar for [Text Scale] to change the size of the text for the label objects.
6. Close the main menu.

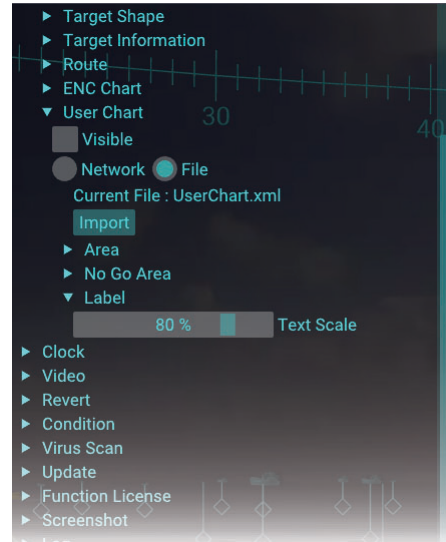

### 1.10 UKHO Charts (Current/Tide Information)

The AR navigation system can show the UKHO charts (current and tide information) by sharing the ADP with the ADP PC. To use this function, connect with the ADP PC that the FURUNO CAST ADP (option software) is installed, via LAN.

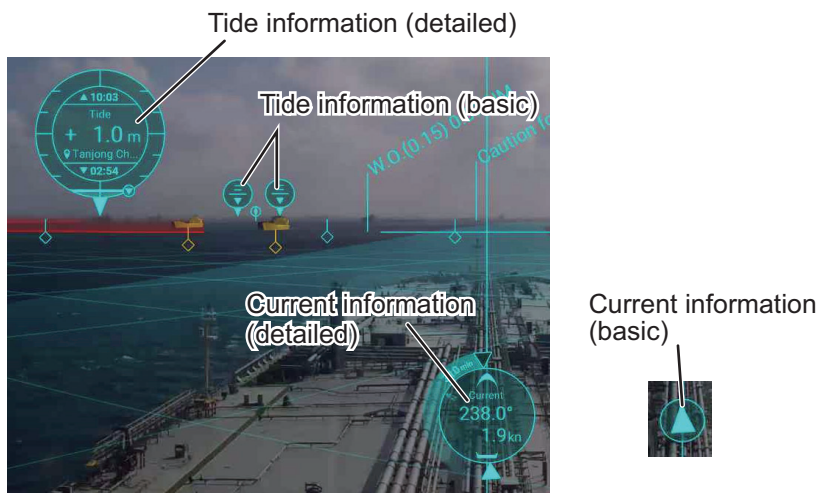

Click the tide/current information object to switch between detailed and basic indication.

**Note:** The version of the ADP whose operation is confirmed is “19,0,0,520”. If a different version is used on the ADP PC, it may not be possible to acquire the UKHO charts properly.

#### Description of terms

Terms	Description
UKHO	United Kingdom Hydrographic Office The UKHO is the UK's agency for providing hydrographic and marine geo-spatial data to mariners and maritime organizations across the world.
ADP	ADMIRALTY Digital Publication The ADP is the digital version of the nautical publications that works in a Windows® environment, and functions to display current, tide, lights, radio signals, etc.

Terms	Description
UKHO chart	Various data displayed in the ADP (current, tide, lights, radio signals, etc.).
ADP PC	The PC where the ADP and FURUNO CAST ADP are installed.

**Current information**

Detailed indication	Basic indication
<p>Remainig minute until completing the turn of tide</p> <p>Current direction after turn of tide</p> <p>North mark</p> <p>Current direction</p> <p>Current speed</p> <p>Current direction</p>	<p>Current direction</p> <p>Indication when current speed is 0 kn</p>

**Note:** You can select how to display the current direction. [Flow From] shows from what direction the current is flowing; [Flow To] shows the direction the current is heading. See section 1.10.3.

**Tide information**

	With high/low tide data	Without high/low tide data
Detailed indication	<p>Time of high tide</p> <p>Height of tide/ Change direction of tide</p> <p>Height of tide</p> <p>Observation point name</p> <p>Time of low tide</p>	
Basic indication	<p>Height of tide</p> <p>Change direction of tide</p>	

# 1. OPERATION

## 1.10.1 How to activate the UKHO charts display function

To display UKHO charts, enter the activation code and activate the function.

1. Click the menu button to open the main menu.
2. Click [Function License].
3. Click the [Activate] button.

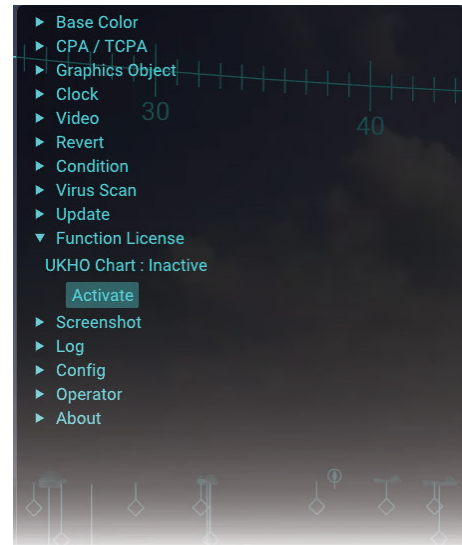
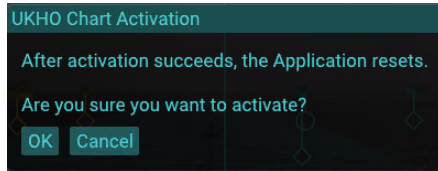

4. Click the [OK] button.

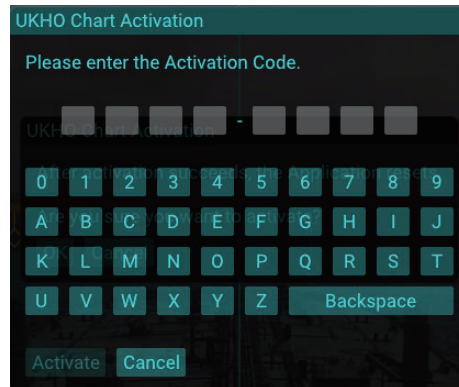

5. Enter the activation code (8 digits), then click the [Activate] button.

**Note 1:** If the activation code is invalid, the message shown in the figure to the right appears. Close the message, then enter the correct activation code. Be careful not to mistake “O” (alphabet) for “0” (zero), “I” (alphabet) for “1” (one).

**Note 2:** If used activation code is entered, the message shown in the figure to the right appears. Close the message, then enter a new, unused activation code.

6. Click the [OK] button.
7. Close the main menu.

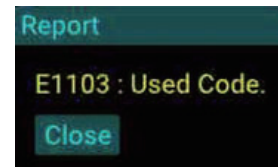
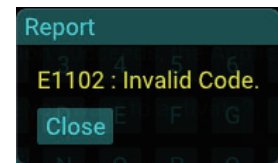
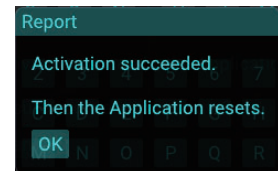

### 1.10.2 How to show/hide user charts

1. Click the menu button to open the main menu.
2. Click [Graphics Object].
3. Click [UKHO Chart].  
**Note:** [UKHO Chart] appears on the main menu only when UKHO charts display function is activated.
4. Check the checkbox for [Visible] to show the UKHO chart objects. If you want to hide the objects, remove the check mark from the checkbox.
5. Close the main menu.

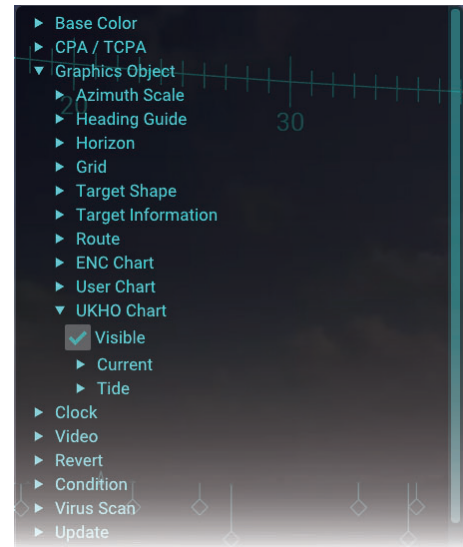

### 1.10.3 How to set the current information

1. Click the menu button to open the main menu.
2. Click [Graphics Object].
3. Click [UKHO Chart].  
**Note:** [UKHO Chart] appears on the main menu only when UKHO charts display function is activated.
4. Click [Current].
5. Adjust the slider bar for [Range] to adjust the display range of the current information.
6. Activate the [Flow From] or [Flow To] radio button.
  - [Flow From]: Shows from what direction the current is flowing.
  - [Flow To]: Shows the direction the current is heading.
7. Close the main menu.

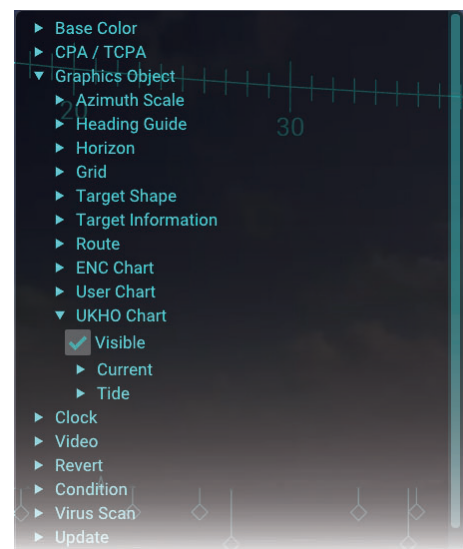

### 1.10.4 How to set the tide information

1. Click the menu button to open the main menu.
2. Click [Graphics Object].
3. Click [UKHO Chart].  
**Note:** [UKHO Chart] appears on the main menu only when UKHO charts display function is activated.
4. Click [Tide].
5. Adjust the slider bar for [Range] to adjust the display range of the tide information.
6. Close the main menu.



### 1.10.5 How to deactivate the UKHO charts display function

1. Click the menu button to open the main menu.
2. Click [Function License].

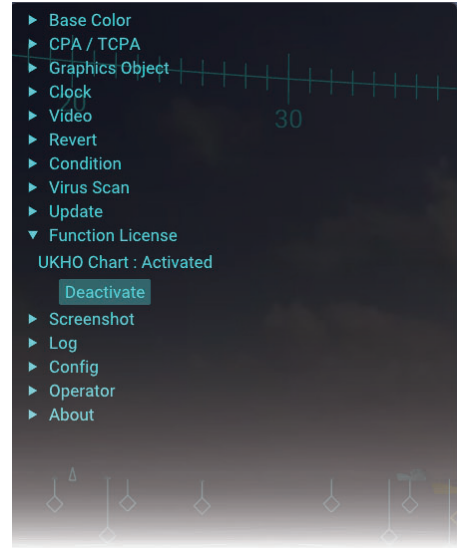

3. Click the [Deactivate] button.



**Note:** If the ZDA sentence has not been input after activating the UKHO chart display function, the following message appears and you cannot deactivate the function,

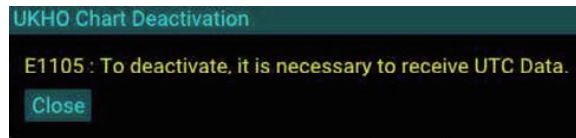

4. Check the following notice. If accepted, click the checkbox for [Confirmed], then click the [Deactivate] button.

**NOTICE** You cannot reuse the activation code used when the function was activated. Therefore, if you deactivate the function, you need to get a new activation code for reactivation.

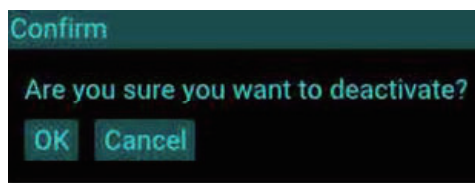

5. Click the [OK] button to activate the function,

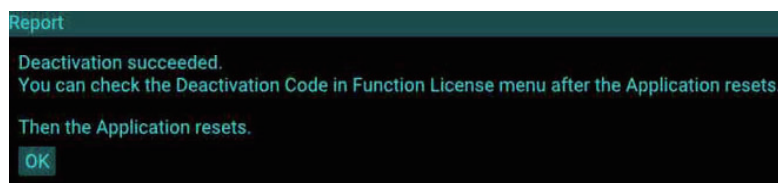



- Click the [OK] button.

After the deactivation is completed, the [Code] button appear on the [Function License] menu. Click the [Code] button to show the UKHO chart deactivation code.



Click the [Code] button.



## 1.11 How to Select Time Format, Set Local Time

The date indication at the upper left of the screen shows either UTC (Universal Time, Coordinated) time and date, or local time and date. To select time format and set local time, do as follows.

- Click the menu button to open the main menu.
- Click [Clock].
- Activate the [UTC] or [Local] radio button.
- When [Local] is selected at step 3, adjust the time difference between the local time and UTC time, in hours and minutes. Select "+" if the local time is ahead of the UTC time, or "-" if it is behind the UTC time. If [UTC] is selected, go to next step.
- Close the main menu.

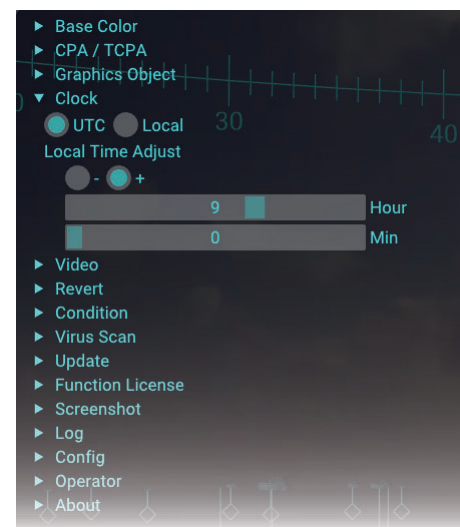

## 1.12 How to Adjust the Video Image Brilliance

You can adjust the brilliance of the video image from the IP camera. If you want to emphasize the AR navigation objects on the screen, decrease the brilliance.

**Note:** This function does not adjust the display brilliance. To adjust the display brilliance, see the operator's manual of the monitor unit.

1. Click the menu button to open the main menu.
2. Click [Video].
3. Adjust the slider bar for [Brightness] to adjust the video image brilliance.
4. Close the main menu.



## 1.13 How to Adjust the Video Image Position

When an AR object is not aligned with the target (AIS target, buoy, etc.) on the screen, adjust the video image position to overlay correctly the object on the target.

**Note:** Do not move the IP camera after installation. When you want to adjust the video image position, do as follows.

1. Click the menu button to open the main menu.
2. Click [Video].
3. Check the checkbox for [Visible Matching Controller] to show the visible matching controller.
4. Show the horizon line and target shape, referring to subsection 1.8.3 and subsection 1.8.8.



Visible matching controller

5. Click the buttons on the visible matching controller to adjust video image position, considering the following points.
  - The horizon line must be aligned with the horizon on the screen.
  - The target shape must be aligned with the actual AIS target. It is recommended to select an AIS target that is stationary.
  - The selective marker for the TT target must be aligned with the actual TT target.

**Note:** When the IP camera position is offset from the ship's center, the heading guide is not aligned with the ship's bow on the video image, due to the offset applied.

Adjusting example

1 Before adjusting

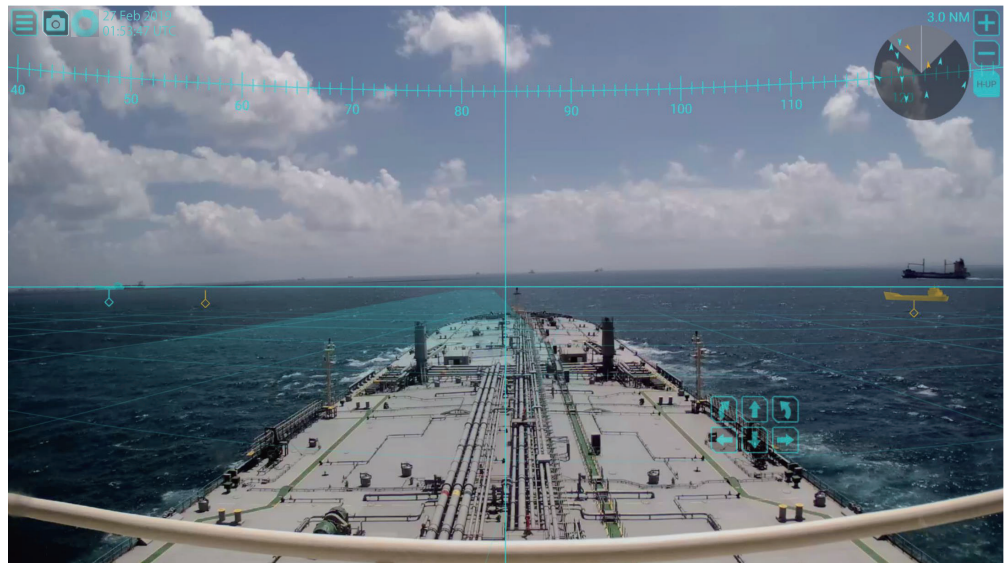

2 Roll adjusting

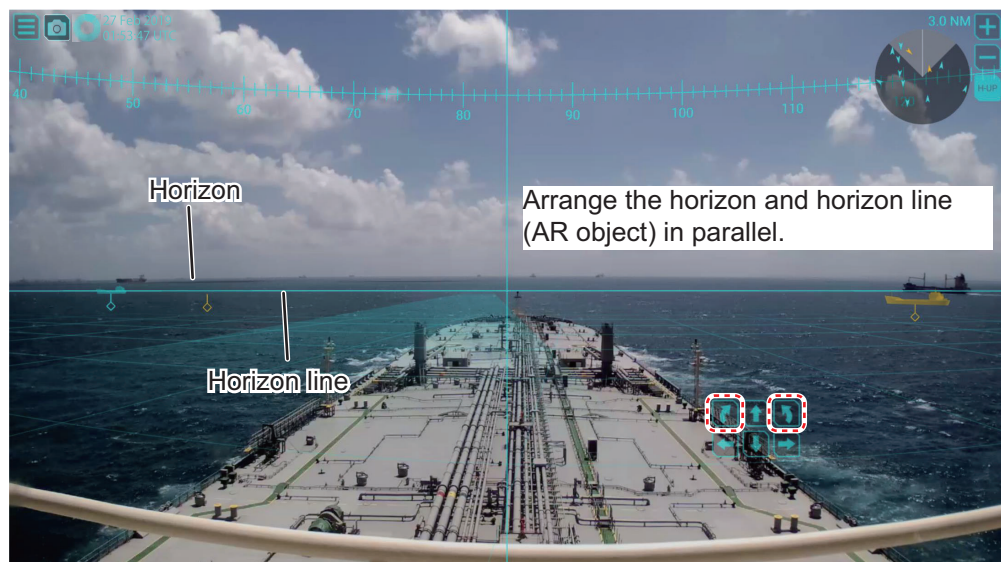

# 1. OPERATION

## 3 Pitch adjusting

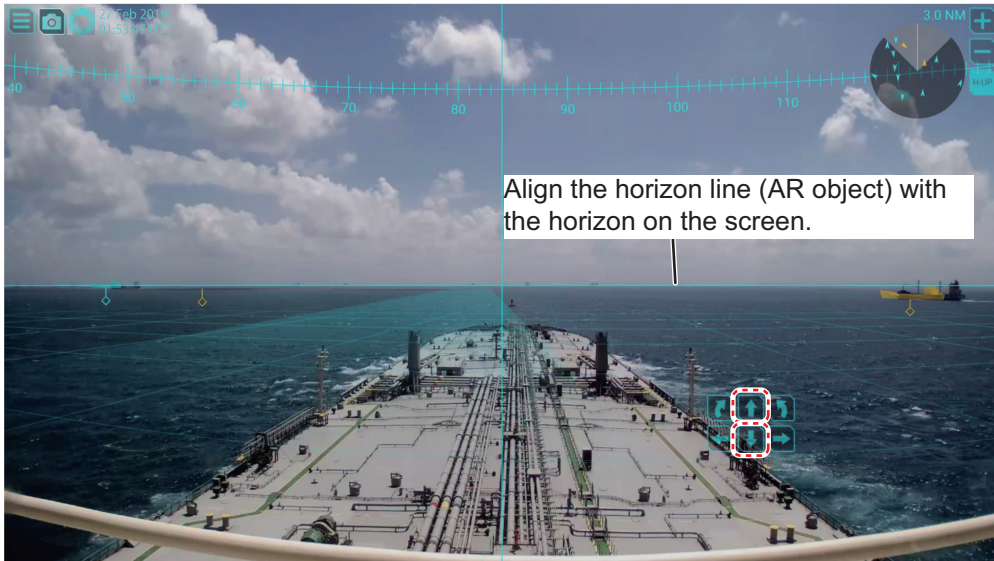

## 4 Yaw adjusting

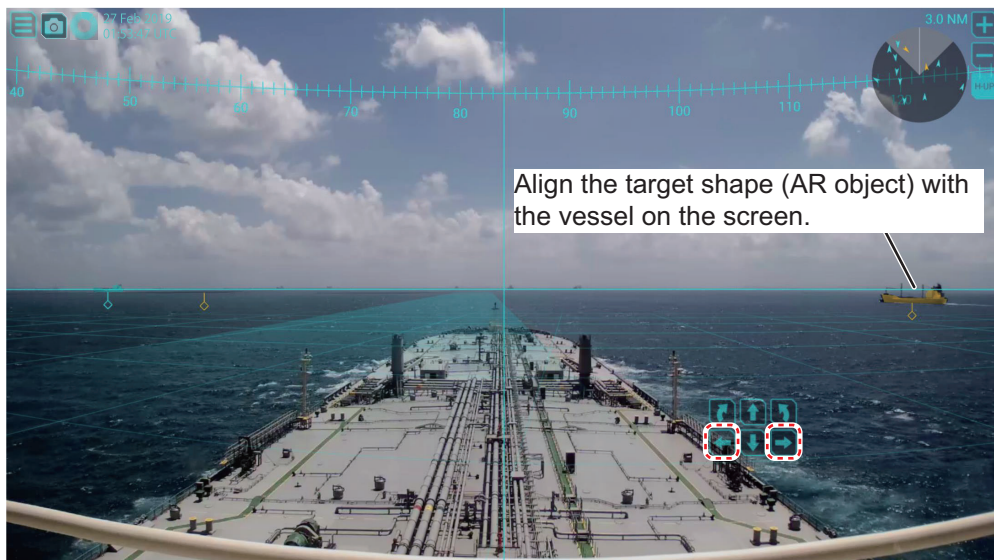

6. Hide the horizon line and matching controller. The target shape feature may be kept on if its use is necessary.  
To hide the matching controller, uncheck the checkbox for [Visible Matching Controller].

**Note:** It takes approx. five seconds to save the configuration. When you adjust the video image position for initial settings, restart the AR navigation system. After restarting the AR navigation system, confirm that the AR navigation objects are correctly aligned with their respective targets on the screen.

## 1.14 Screenshots

You can save a screenshot of the on-screen display and play it back at any time.

### 1.14.1 How to take a screenshot

To take a screenshot, click the screenshot button on the top-left of the display. The screenshot is saved in the main PC. The file format for saved screenshots is PNG. The date and time the file was saved are used for the file name. For example, when the screenshot is saved at 03:04:05, February 1, 2020, the file name is "20200102\_030405.png".

**Note:** If the disk capacity is insufficient to take a screenshot, the error message shown in the figure to the right appears. Delete unnecessary screenshots referring to subsection 1.14.3. You can confirm the disk capacity status in the main PC from the main menu → [Screenshot].

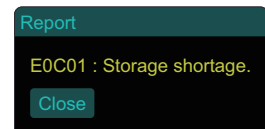

### 1.14.2 How to copy screenshots to a USB flash memory

You can copy screenshot files to a USB flash memory.

1. Insert a USB flash memory to the USB port on the main PC.
2. Click the menu button to open the main menu.
3. Click [Screenshot].
4. Click [Data Management].

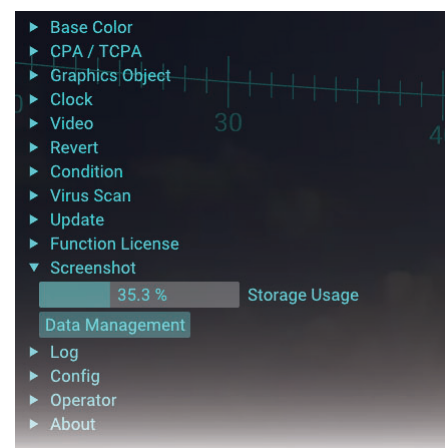

Check/uncheck all checkboxes.

Checkbox: Select a screenshot(s) to copy/delete.

[Export] button: Copies screenshots whose checkbox is checked.

[Close] button: Closes this window.

[Delete] button: Deletes screenshots whose checkbox is checked.

Preview: To preview the screenshot, click the file name on the list at the left of the window.

## 1. OPERATION

5. Check the checkbox(es) to copy the screenshot(s).
6. Click the [Export] button.

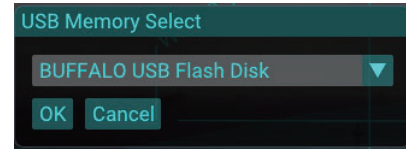

**Note:** If the USB flash memory cannot be detected, the error message shown in the figure to the right appears. Insert the USB flash memory to the main PC.

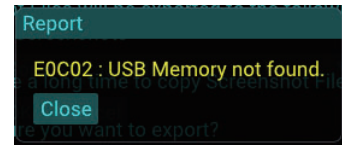

7. Select the USB flash memory as saving destination from the drop-down list.
8. Click the [OK] button.  
The message shown in the figure to the right appears.

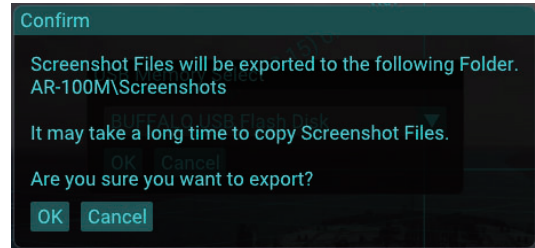

9. Click the [OK] button to start copying screenshots.  
The message shown below-left appears while copying screenshots. After completing the file copy, the confirmation message shown below-right appears.

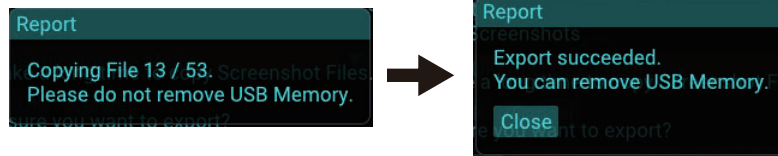

**Note 1:** If the disk capacity of the USB flash memory is insufficient to copy screenshots, the error message shown in the figure to the right appears. Make sure that there is enough space in the USB flash memory.

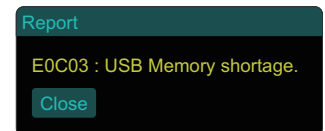

**Note 2:** Do not remove the USB flash memory during the copying. If the flash memory is removed, the message shown in the figure to the right appears. Close the message and retry copying screenshots after inserting the USB flash memory.

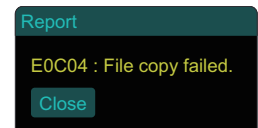

10. Click the [Close] button.

### 1.14.3 How to delete screenshot files

You can delete screenshot files as follows.

1. Click the menu button to open the main menu.
2. Click [Screenshot].
3. Click [Data Management].
4. Check the checkbox(es) to delete screenshot file(s).
5. Click the [Delete] button.  
The message shown in the figure to the right appears.

6. Click the [OK] button.
7. Click the [Close] button.

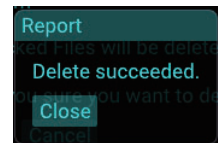
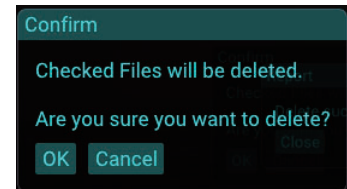

1. OPERATION

This page is intentionally left blank.



# 2. INSTALLATION AND INITIAL SETTINGS

---

The procedure for the installation of the AR navigation system is as follows.

- 1) Mount and wire each unit, referring to section 2.1 and section 2.2.
- 2) Login as a service technician and enter the initial settings, referring to section 2.3.
- 3) Confirm the system operation, referring to section 2.4.

## 2.1 Mounting

### 2.1.1 Main PC

**Note:** Locate the unit away from direct sunlight.

1. Unfasten four screws to remove the four foot pads at the bottom of the main PC.

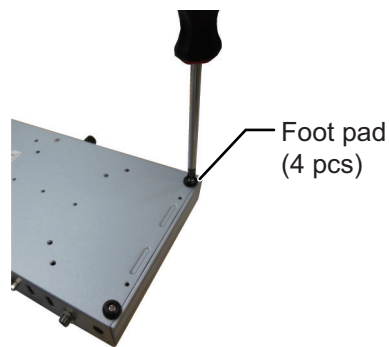

2. Insert the supplied four countersunk screws to the screw hole for the foot pad.

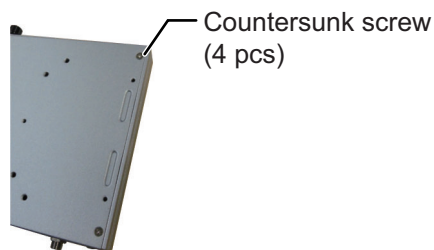

3. Attach two mounting brackets to the main PC, using the supplied screws.

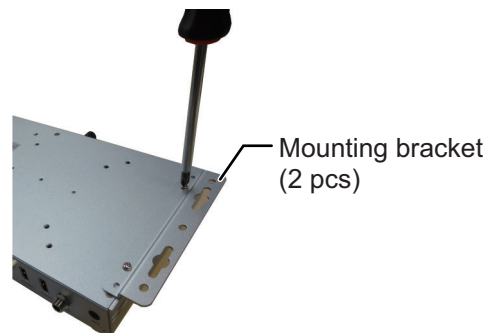

4. Drill four pilot holes in the mounting location for the mounting screws.
5. Secure the unit using the four supplied self-tapping screws and flat washers.

## 2. INSTALLATION AND INITIAL SETTINGS

### 2.1.2 PoE adapter

**Note:** Locate the unit away from direct sunlight.

1. Clean the bottom of the PoE adapter and mounting location.
2. Attach the supplied four adhesive mats to the bottom of the PoE adapter, referring to the following illustration.



3. Set the PoE adapter to the mounting location.

### 2.1.3 IP camera

**Note:** Select the mounting location which gives the shortest distance between the IP camera and the monitor unit. When the IP camera is far from the monitor unit, the parallax error between the view from the monitor unit position and IP camera increases.

1. Drill four pilot holes in the mounting location for the mounting screws.
2. Secure the camera bracket using the four supplied self-tapping screws.
3. Mount the IP camera to the top of the camera bracket.

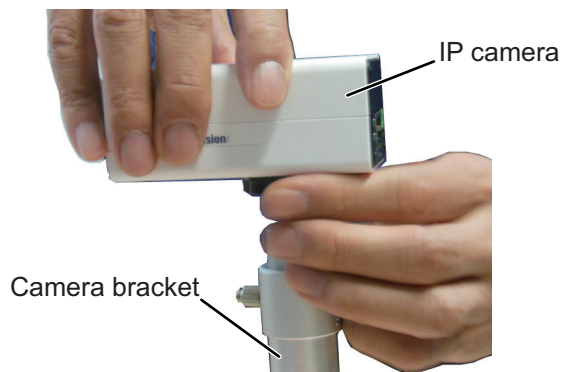

4. Face the IP camera to the ship's bow direction, then fasten the bolt, using the supplied knob, to lock the IP camera.

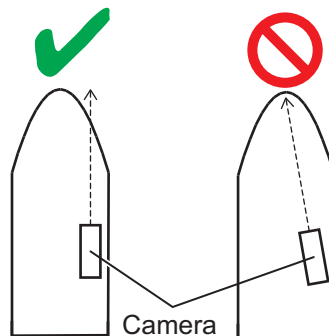

5. After locking the IP camera, remove the knob from the camera bracket.

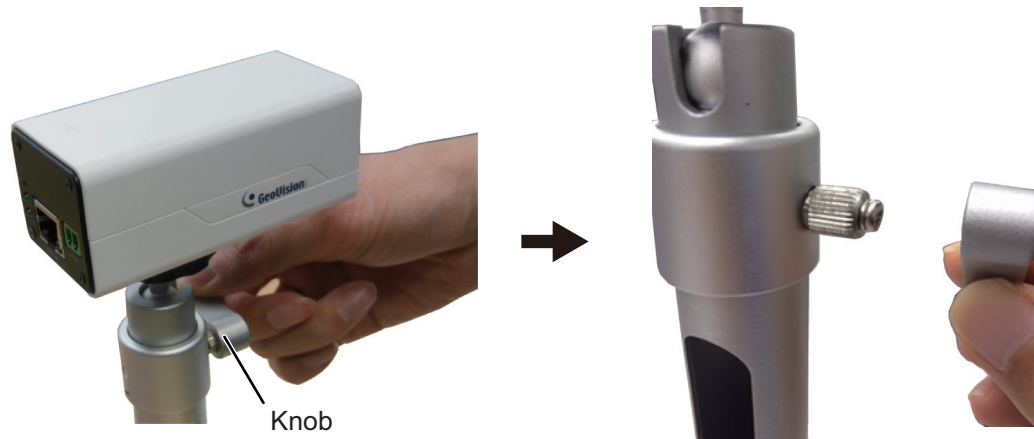

Fasten the bolt using the knob to lock the IP camera.

Remove the knob after fastening the bolt and locking the IP camera.

**Note 1:** Retain the knob to unfasten/fasten the bolt on the camera bracket.

**Note 2:** Do not move the IP camera after installation. When you want to adjust the video position, see section 1.13.

#### 2.1.4 Trackball

You can control almost all aspects of your AR navigation system from the trackball. Locate the unit where it can easily be operated, and easily connected to the main PC.

#### 2.1.5 Sensor adapter (option)

##### Mounting considerations

When you select a mounting location, keep in mind the following points:

- Locate the adapter away from heat sources because of heat that can build up inside the cabinet.
- The vibration should be minimal.
- Locate the equipment away from places subject to water splash and rain.
- Make sure that the ground wire is connected between the earth terminal on chassis and the ship's earth.
- Leave sufficient space at the sides and rear of the unit to facilitate maintenance.
- A magnetic compass will be affected if the adapter is placed too close to the magnetic compass. Observe the compass safe distances at the front of this manual to prevent interference to a magnetic compass.

## 2. INSTALLATION AND INITIAL SETTINGS

### **How to mount the sensor adapter**

1. Unfasten four binding screws to remove the cover from the sensor adapter.
2. Fasten four self-tapping screws ( $\phi 4 \times 20$ , supplied) to fix the sensor adapter.
3. Reattach the cover.

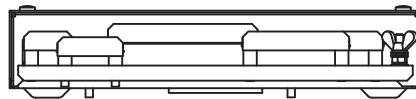
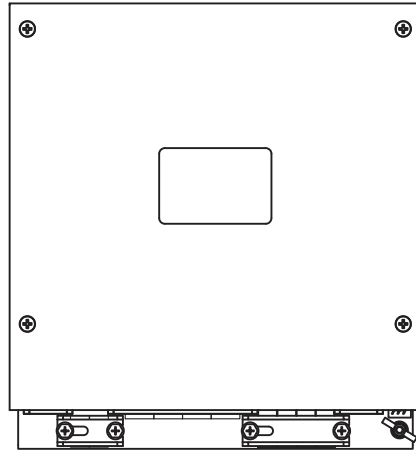

MC-3000S

## 2.2 Wiring

### 2.2.1 Main PC

#### Interface

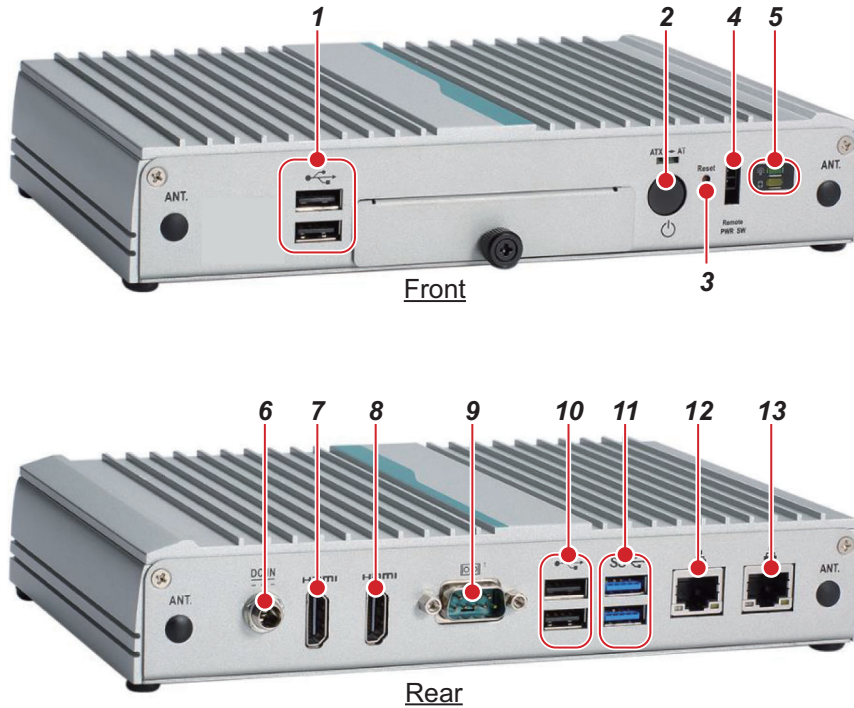

No.	Name	Description
1	USB2.0 Port	2 × USB2.0, used for connecting the trackball, ENC dongle, USB flash memory and USB keyboard*. <b>Note:</b> Do not connect a USB device other than the above-mentioned devices.
2	Power Button	Turns the system on/off.
3	Reset Button	Resets the system.
4	Remote PWR Switch Port	Connect a remote switch (locally supplied), using the supplied remote switch cable, to turn the system on/off from the remote switch.
5	LED Indicator	Upper is for power, lower is for SSD.
6	12 VDC Power Input Port	Connect the supplied AC adapter.
7	HDMI 2 Port	Not used.
8	HDMI 1 Port	Connect a monitor unit (locally supplied), using the supplied HDMI cable. It is recommended to use a monitor whose resolution is full HD (1920 × 1080).
9	Serial Port	RS-232C port, Not used.
10	USB2.0 Port	2 × USB2.0, used for connecting the trackball, ENC dongle, USB flash memory and USB keyboard*. <b>Note:</b> Do not connect a USB device other than the above-mentioned devices.
11	USB3.0 Port	2 × USB3.0, used for connecting the trackball, ENC dongle, USB flash memory and USB keyboard*. <b>Note:</b> Do not connect a USB device other than the above-mentioned devices.

## 2. INSTALLATION AND INITIAL SETTINGS

No.	Name	Description
12	LAN2 Port	Connect the IP camera through the PoE adapter.
13	LAN1 Port	Connect the HUB-3000 to communicate with the bridge navigational equipment.

\*: The USB keyboard is used only for adjusting the initial settings menu. To prevent unintended operation, do not connect the USB keyboard during normal use of the system.

**Note:** An ENC dongle is necessary to share the ENC charts from the ECDIS. Keep the ENC dongle connected to one of the USB ports on the main PC while using the AR navigation system.

### Hiding the LED indicators

If the LED indicators on the main PC and the ENC dongle are too bright at night, cover them with vinyl tape. The location of the LED indicator is shown in the following figure.

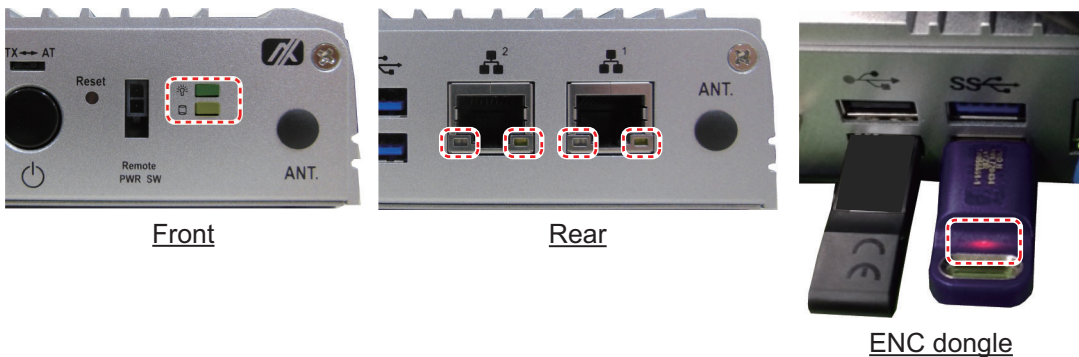

### Remote PWR switch

Connect a remote switch (supplied locally) to the Remote PWR switch port, to turn the system on/off from a remote switch.

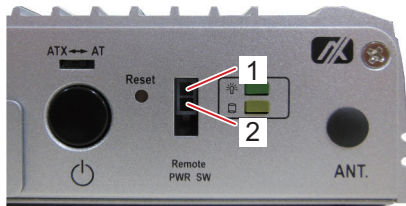

Status	Description
Short 1 and 2.	Turn the system on/off.
Open	-

### 2.2.2 PoE adapter

The PoE adapter supplies the power to the IP camera through the LAN cable and interfaces the data between the main PC and IP camera.

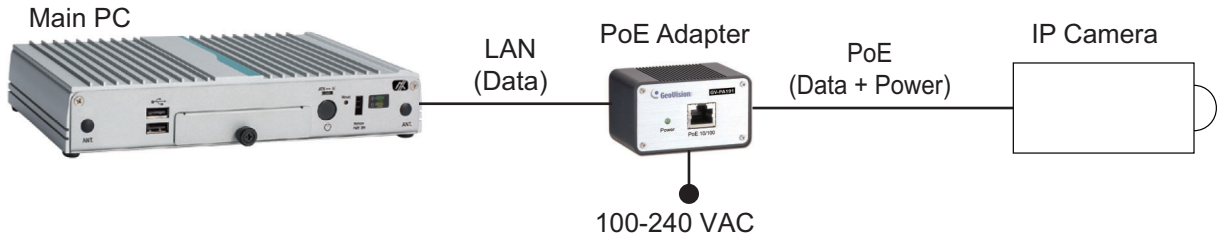

#### Interface

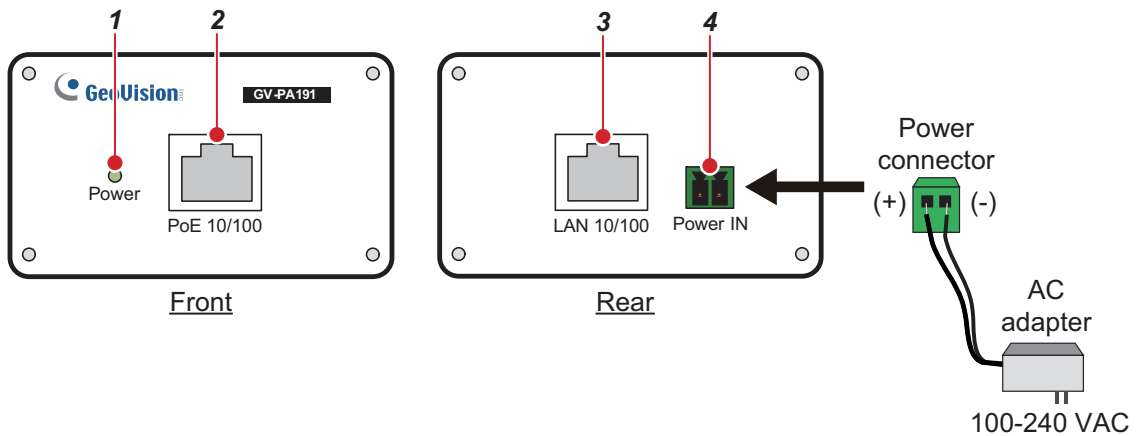

No.	Name	Description
1	Power Indicator	The LED (green) lights when the power is supplied to the PoE adapter.
2	PoE 10/100	Output the PoE power (48 VDC). Connect with the IP camera, using the LAN cable.
3	LAN 10/100	Connect with the main PC, using the LAN cable.
4	Power IN	Connect with the ship's supply (100-240 VAC), using the supplied AC adapter and power connector.

#### Hiding the LED indicator

If the LED indicator is too bright at night, cover it with vinyl tape. The location of the LED indicator is shown in the figure to the right.

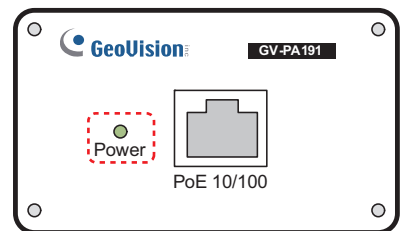

## 2. INSTALLATION AND INITIAL SETTINGS

### 2.2.3 IP camera

The IP camera is powered from the PoE adapter through the Ethernet interface using PoE (Power over Ethernet). Connect the IP camera to the PoE adapter, using the supplied LAN cable.

**Note:** Be sure to connect the LAN cable vertically. After the connection, secure the LAN cable to the bracket, using a cable tie (supplied locally).

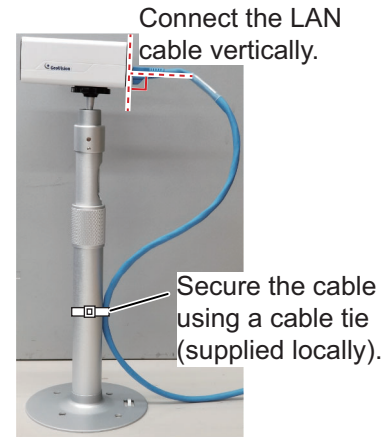

#### Interface (GV-EBX2100)

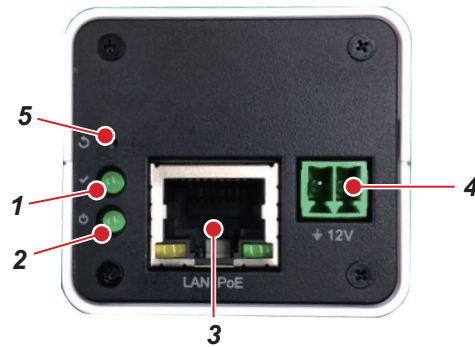

No.	Name	Description
1	Status Indicator	The LED (green) lights when the IP camera works correctly. In the default setting, the status indicator LED stays off regardless of the IP camera working status.
2	Power Indicator	The LED (green) lights when the power is supplied to the IP camera.
3	LAN/PoE	Connect with the PoE adapter, using the supplied LAN cable.
4	DC IN (12 V)	Not used.
5	Reset Button	Not used. If you press this button unintentionally, communication error between the main PC and the IP camera occurs and the screen is not displayed correctly. Contact your dealer.

#### Hiding the LED indicators

If the LED indicators are too bright at night, cover them with vinyl tape. The LEDs which are active (lit) when the camera is turned on have their locations indicated with dashed lines in the figure to the right.

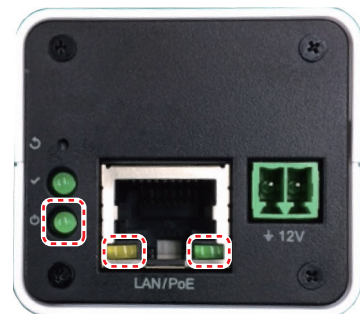

GV-EBX2100



## 2.2.4 Sensor adapter (option)

Use the ferrule-type terminals (supplied) to connect the cables to the terminals in the sensor adapters. This connection requires a crimping tool (CRIMPFOX10S, option). For the relations between the connectors and rod terminals, see page AP-2. Also, the stickers attached on the reverse side of the covers show the detailed connections.

### How to attach ferrule-type lug

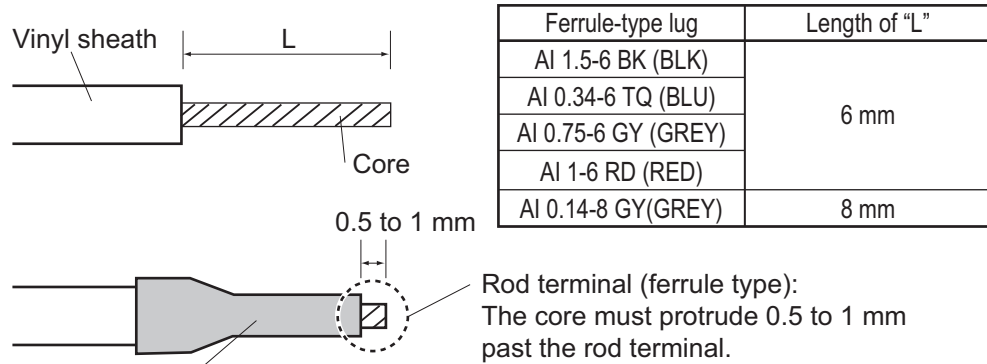

Rod terminal (ferrule type):

After attaching the rod terminal, use the optional crimping tool CRIMPFOX 10S to crimp.

## 2. INSTALLATION AND INITIAL SETTINGS

### Fabrications

- LAN cable

Attach the modular plug as shown in the following figure.

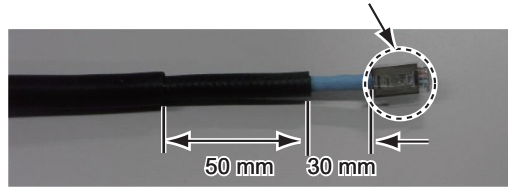

1 Expose inner vinyl sheath.

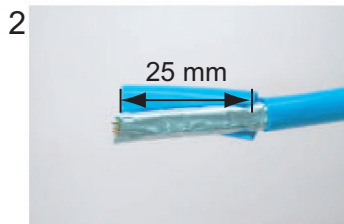

2 Remove the inner vinyl sheath by approx 25 mm. Be careful not to damage inner shield and cores.

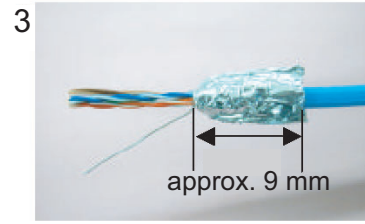

3 Fold back the shield, wrap it onto the inner vinyl sheath and cut it, leaving 9 mm.

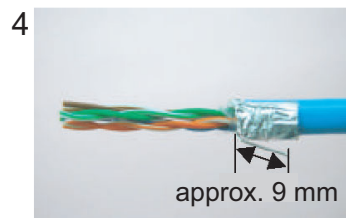

4 Fold back drain wire and cut it, leaving 9 mm.

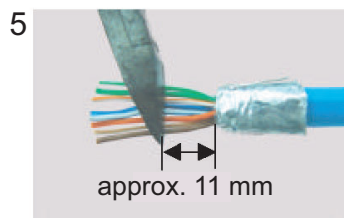

5 Straighten and flatten the cores in order and cut them, leaving 11 mm.

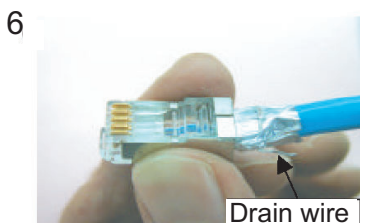

6 Insert the cable into the modular plug so that the folded part of the shield enters into the plug housing. The drain wire should be located on the tab side of the jack.



7 Using special crimping tool MPT5-8AS (PANDUIT CORP.), crimp the modular plug. Finally check the plug visually.

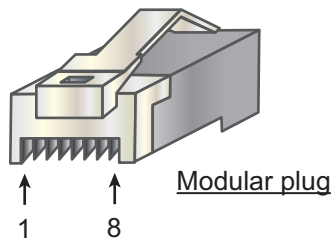

[Cross cable]



[Straight cable]

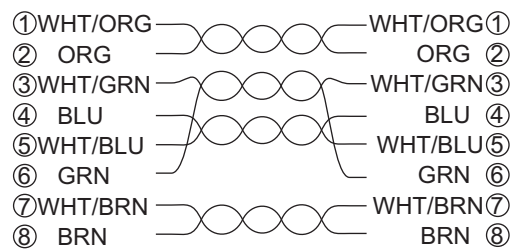

## 2. INSTALLATION AND INITIAL SETTINGS

### • TTYCS-1Q cable

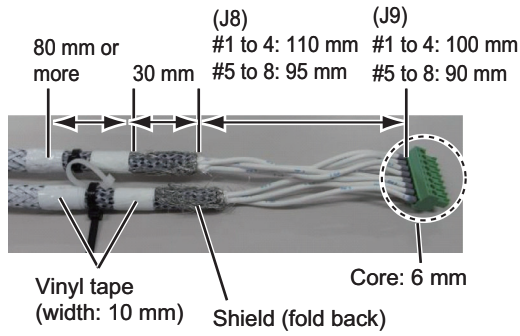

### • TTYCSLA-1Q cable

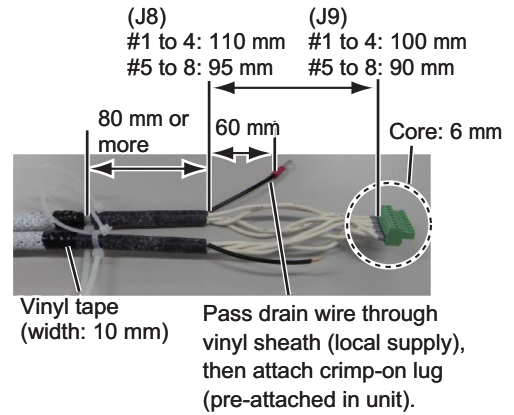

### • TTYCS-1 cable

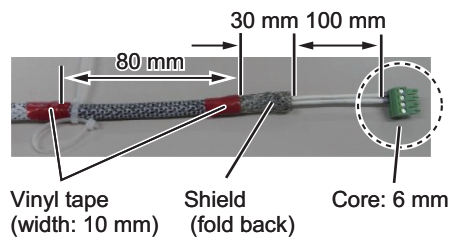

### • TTYCSLA-1 cable

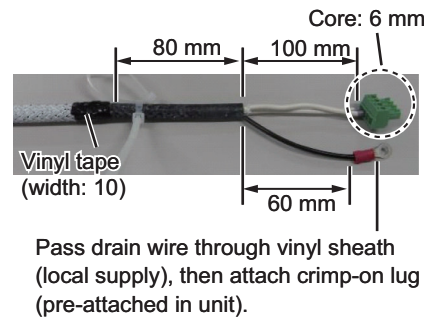

### • TTYCS-4 cable

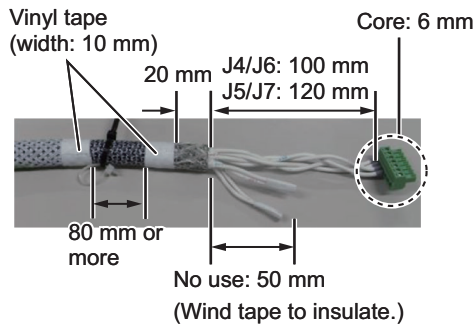

### • TTYCSLA-4 cable

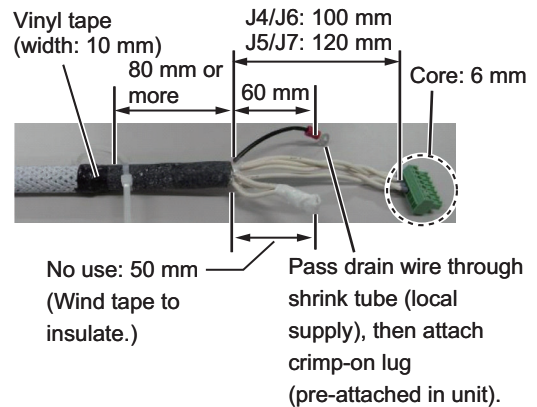

### • DPYC-1.5 cable

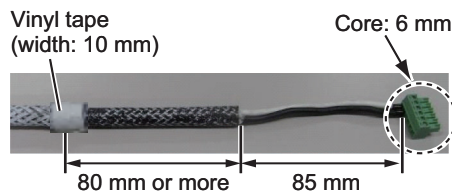

## 2. INSTALLATION AND INITIAL SETTINGS

### Connections

Unfasten four screws to remove the cover, pass the cables through the clamps and attach the cables to respective connectors. The shield part of the cable (or drain wire) must be fastened by (connected to) the clamp.

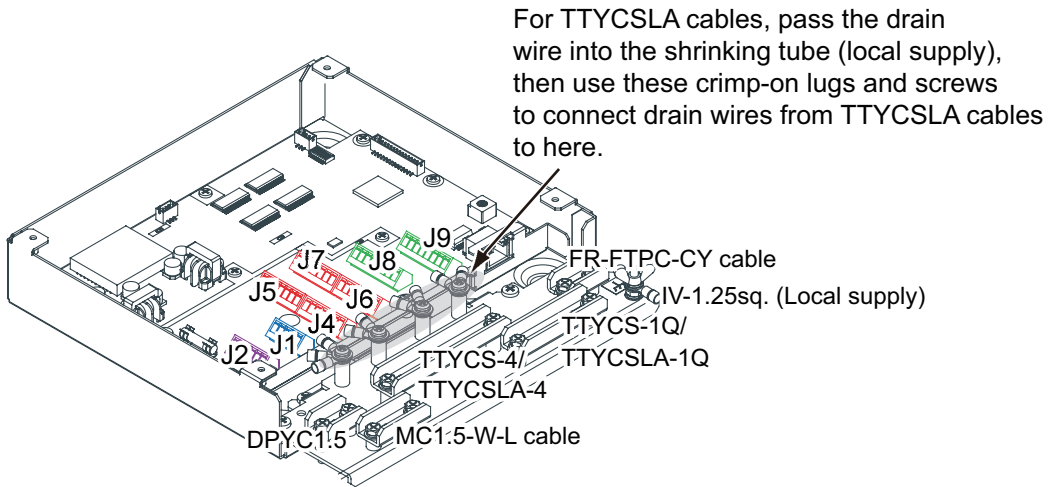

**Note:** Fasten the cable shield with the cable clamp.

### How to set NC/NO output (J2)

The POWER FAIL signal on the connector J2 can be set to NC (normal close) output or NO (normal open) output as shown in the table below.

#### Connector J2

Pin #	Signal name	In/Out	Description	NO	NC
1	24V_IN	-	24 VDC	DPYC-1.5	
2	24V_GND	-	GND (24 VDC)		
3	PWR_FAIL_A	Out	Power fail output	TTYCS(LA)-1	No connection
4	PWR_FAIL_COM	Out	Power fail output		TTYCS(LA)-1
5	PWR_FAIL_B	Out	Power fail output	No connection	

**How to set input specification (J4 to J9)**

For connectors J4 to J7, the connections are different depending on the input specifications as shown below.

**Connector J4**

Pin #	Signal name	In/Out	Description	IEC 61162-2	IEC 61162-1	Modbus*		
1	TD1-A	Out	Serial CH1, output IEC 61162-1/2/modbus	TTYCS(LA)-4	TTYCS(LA)-4	TTYCS(LA)-4		
2	TD1-B	Out	Serial CH1, output IEC 61162-1/2/modbus					
3	RD1-A	In	Serial CH1, input IEC 61162-2/modbus				No connection	No connection
4	RD1-B	In	Serial CH1, input IEC 61162-2/modbus					
5	ISOGND1	-	Isolation, GND (CH1)					
6	RD1-H	In	Serial CH1, input IEC 61162-1	No connection	TTYCS(LA)-4			
7	RD1-C	In	Serial CH1, input IEC 61162-1					

\*: Set the jumpers J20/J21 to Modbus.

**Connector J5**

Pin #	Signal name	In/Out	Description	IEC 61162-2	IEC 61162-1	Modbus*		
1	TD2-A	Out	Serial CH2, output IEC 61162-1/2/modbus	TTYCS(LA)-4	TTYCS(LA)-4	TTYCS(LA)-4		
2	TD2-B	Out	Serial CH2, output IEC 61162-1/2/modbus					
3	RD2-A	In	Serial CH2, input IEC 61162-2/modbus				No connection	No connection
4	RD2-B	In	Serial CH2, input IEC 61162-2/modbus					
5	ISOGND2	-	Isolation, GND (CH2)					
6	RD2-H	In	Serial CH2, input IEC 61162-1	No connection	TTYCS(LA)-4			
7	RD2-C	In	Serial CH2, input IEC 61162-1					

\*: Set the jumpers J20/J21 to Modbus.

2. INSTALLATION AND INITIAL SETTINGS

Connector J6

Pin #	Signal name	In/Out	Description	IEC 61162-2	IEC 61162-1
1	TD3-A	Out	Serial CH3, output IEC 61162-1/2	TTYCS(LA)-4	TTYCS(LA)-4
2	TD3-B	Out	Serial CH3, output IEC 61162-1/2		
3	RD3-A	In	Serial CH3, input IEC 61162-2		No connection
4	RD3-B	In	Serial CH3, input IEC 61162-2		
5	ISOGND3	-	Isolation, GND (CH3)		
6	RD3-H	In	Serial CH3, input IEC 61162-1	No connection	TTYCS(LA)-4
7	RD3-C	In	Serial CH3, input IEC 61162-1		

Connector J7

Pin #	Signal name	In/Out	Description	IEC 61162-2	IEC 61162-1
1	TD4-A	Out	Serial CH4, output IEC 61162-1/2	TTYCS(LA)-4	TTYCS(LA)-4
2	TD4-B	Out	Serial CH4, output IEC 61162-1/2		
3	RD4-A	In	Serial CH4, input IEC 61162-2		No connection
4	RD4-B	In	Serial CH4, input IEC 61162-2		
5	ISOGND4	-	Isolation, GND (CH4)		
6	RD4-H	In	Serial CH4, input IEC 61162-1	No connection	TTYCS(LA)-4
7	RD4-C	In	Serial CH4, input IEC 61162-1		

Connector J8

Pin#	Signal name	In/Out	Description	Used cable
1	TD5-A	Out	Serial CH5, output IEC 61162-1	TTYCS-1Q or TTYCSLA-1Q
2	TD5-B	Out	Serial CH5, output IEC 61162-1	
3	RD5-H	In	Serial CH5, input IEC 61162-1	
4	RD5-C	In	Serial CH5, input IEC 61162-1	
5	TD6-A	Out	Serial CH6, output IEC 61162-1	
6	TD6-B	Out	Serial CH6, output IEC 61162-1	
7	RD6-H	In	Serial CH6, input IEC 61162-1	
8	RD6-C	In	Serial CH6, input IEC 61162-1	

Connector J9

Pin#	Signal name	In/Out	Description	Used cable
1	TD7-A	Out	Serial CH7, output IEC 61162-1	TTYCS-1Q or TTYCSLA-1Q
2	TD7-B	Out	Serial CH7, output IEC 61162-1	
3	RD7-H	In	Serial CH7, input IEC 61162-1	
4	RD7-C	In	Serial CH7, input IEC 61162-1	
5	TD8-A	Out	Serial CH8, output IEC 61162-1	
6	TD8-B	Out	Serial CH8, output IEC 61162-1	
7	RD8-H	In	Serial CH8, input IEC 61162-1	
8	RD8-C	In	Serial CH8, input IEC 61162-1	

**Jumper settings**

Set the jumper blocks in the MC-CS Board (24P0114) referring to the tables that follow.

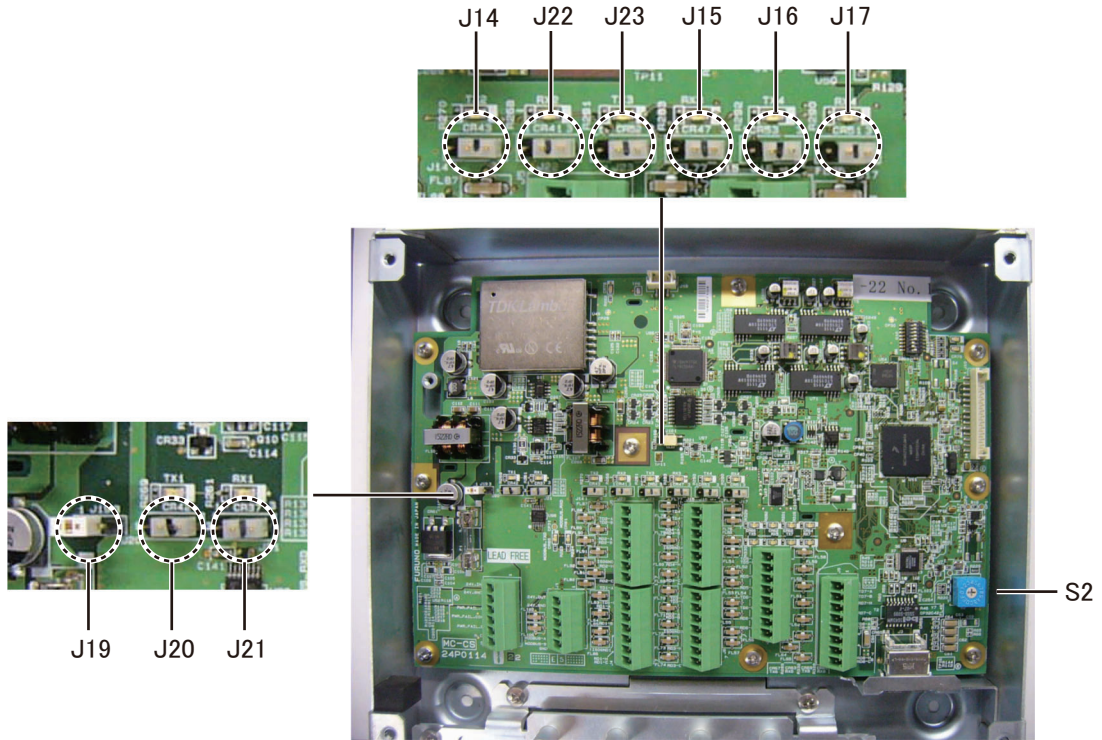

MC-CS Board (24P0114)

**Rotary switch:** Use the rotary switch (S2) to set the Modbus address when setting connectors J4/J5 to Modbus. The Modbus address set at J4/J5 in the network is not used. When setting J4/J5 to IEC 61162-1/2, use the default setting (“0”).

**Jumper block:**

Use the jumper block J19 to set the termination resistor on/off for the MODBUS communication on the connector J1. For the first and last sensor adapter in a series, their termination resistors should be set to ON. Use the MC-CS Board with the default setting because it becomes the “first” adapter in a series.

Jumper block J19		Connector J1
1-2	SHORT	Termination resistor: ON (default setting)
2-3	OPEN	
1-2	OPEN	Termination resistor: OFF
2-3	SHORT	

Set the jumper blocks J14 through J17 to turn the termination resistors on connectors J4 through J7 respectively.

(Termination resistor ON)

- When setting the starting/ending terminal for the multipoint, or the multipoint is not connected (CH1 to 4).
- When setting the starting/ending terminal for Modbus (CH1, CH2)

## 2. INSTALLATION AND INITIAL SETTINGS

(Terminal resistor OFF)

- When setting the terminal other than starting/ending for the multipoint (CH1 to 4).
- When setting the terminal other than starting/ending for Modbus (CH1/CH2)

Jumper block J14		Connector J4 (CH1)
1-2	SHORT	Termination resistor: ON (default setting)
2-3	OPEN	
1-2	OPEN	Termination resistor: OFF
2-3	SHORT	

Jumper block J15		Connector J5 (CH2)
1-2	SHORT	Termination resistor: ON (default setting)
2-3	OPEN	
1-2	OPEN	Termination resistor: OFF
2-3	SHORT	

Jumper block J16		Connector J6 (CH3)
1-2	SHORT	Termination resistor: ON (default setting)
2-3	OPEN	
1-2	OPEN	Termination resistor: OFF
2-3	SHORT	

Jumper block J17		Connector J7 (CH4)
1-2	SHORT	Termination resistor: ON (default setting)
2-3	OPEN	
1-2	OPEN	Termination resistor: OFF
2-3	SHORT	

Set the jumper blocks J20 and J21 to choose the communication type (IEC-61162-1/2 or MODBUS) of the connector J4 (CH1).

The setting of the jumper block JP20 and JP21 must be identical.

Jumper block J20/J21		Communication type of J4 (between RD1 and TD1)
1-2	OPEN	IEC-61162-1/2 (default setting)
2-3	SHORT	
1-2	SHORT	MODBUS (The setting of J14 is different depending on the unit position (starting/ending terminal).)
2-3	OPEN	

The jumper blocks J22 and J23 are used to set the communication type of the connector J5 (CH2).

Jumper block J22/J23		Communication type of J5 (between RD2 and TD2)
1-2	OPEN	IEC-61162-1/2 (default setting)
2-3	SHORT	
1-2	SHORT	MODBUS (The setting of J15 is different depending on the unit position (starting/ending terminal).)
2-3	OPEN	



## 2.3 Initial Settings

**Note 1:** A USB keyboard is required for initial settings. Because the main PC recognizes the US English keyboard layout, connect a US English keyboard.

**Note 2:** USB keyboard operation is required for some initial setting menu items. To edit the value, press and hold the **Ctrl** key, then click the setting value.

### 2.3.1 How to login as a service technician

Login as a service technician, to access the menu items for initial settings. Do as follows to login as a service technician.

**Note:** Contact FURUNO for the operator name and password for login.

1. Connect a USB keyboard to the main PC.  
**Note:** The USB keyboard is used only for adjusting the initial settings menu. To prevent unintended operation, do not connect the USB keyboard during normal use of the system.
2. Click the menu button to open the main menu.
3. Click [Operator].
4. Input the operator name in the [Operator] field.
5. Input the password in the [Password] field.
6. Click the [Login] button.  
When you login successfully, the message to the right appears.
7. Click the [Close] button to close the message.

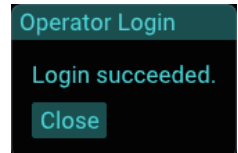
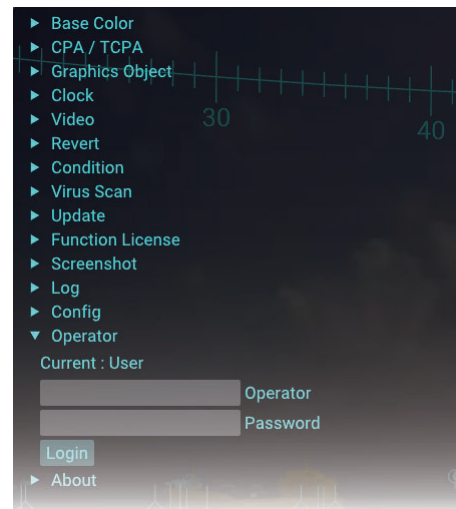

The following section explains the operation on the premise that you login as a service technician. Click the [Logout] button to logout after completing all settings.

### 2.3.2 Initial settings for the IP camera

Adjust the field of view of the video image and enter the position of the IP camera.

**Note:** Before adjusting the field of view of the IP camera, confirm that the IP camera faces the bow direction and adjust the video image position, referring to section 1.13. If the limit line of the video image appears on the screen after adjusting the video image position, adjust the field of view so that the limit line is not shown on the display. When you adjust the field of view for the IP camera, the viewing range decreases. Therefore, keep the default field of view when feasible.

1. Click the menu button to open the main menu.
2. Click [Service Setting].
3. Click [Camera].
4. Adjust the slider bar for [Field of View] to adjust the field of view for the IP camera.
5. Adjust the slider bar for [Altitude] to adjust the distance between average water line and IP camera location.
6. Adjust the slider bar for [Position] to set the IP camera location calculated from the location of the EPFS device to use as a reference.

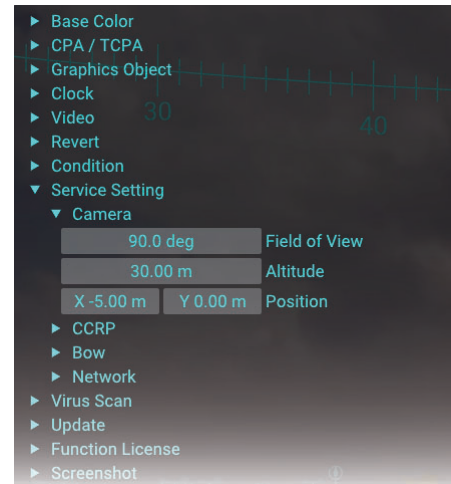

- [X]: Set the port-starboard (lateral) location of the IP camera, which is calculated from the location of the EPFS device.
- [Y]: Set the bow-stern (longitudinal) location of the IP camera, which is calculated from the location of the EPFS device.

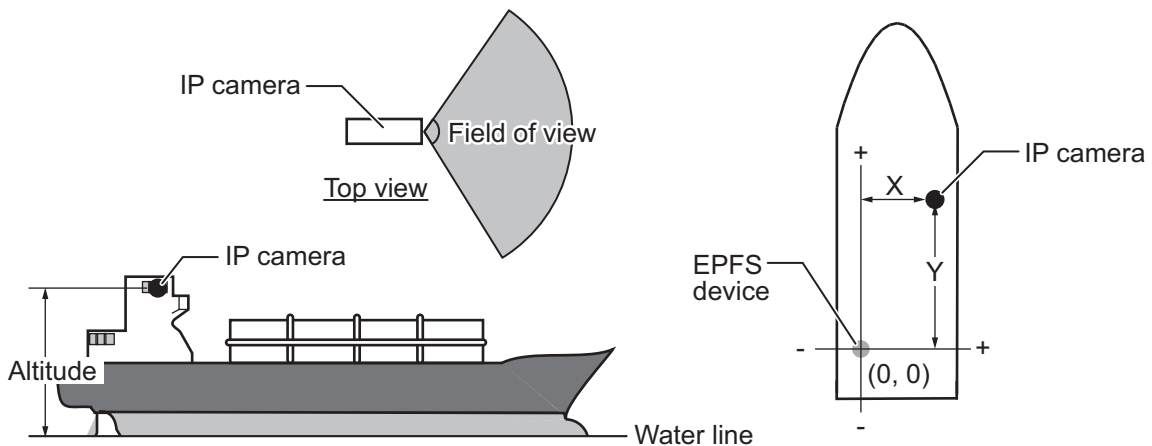

7. Close the main menu.

### 2.3.3 How to setup the CCRP

Do as follows to setup the CCRP (Consistent Common Reference Position). The AR navigation system uses CCRP as reference points for CPA/TCPA calculations.

1. Click the menu button to open the main menu.
2. Click [Service Setting].

- Click [CCRP].

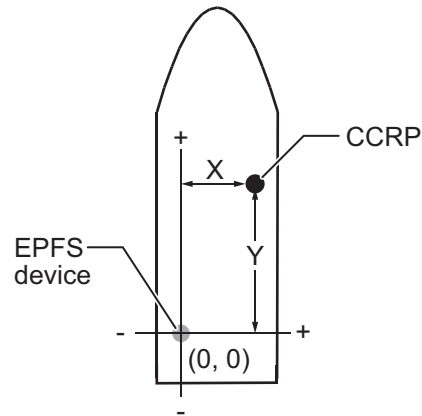
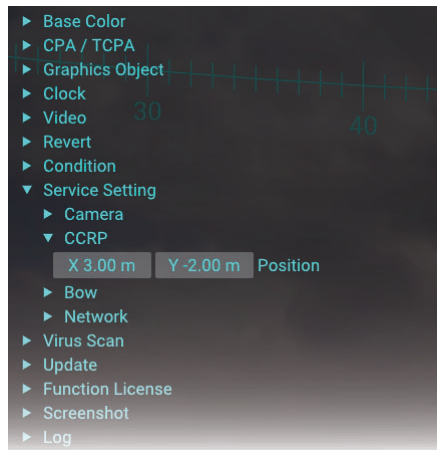

- Adjust the slider bar for [Position] to set the CCRP calculated from the location of the EPFS device to use as a reference.
  - [X]: Set the port-starboard (lateral) location of the CCRP, which is calculated from the location of the EPFS device.
  - [Y]: Set the bow-stern (longitudinal) location of the CCRP, which is calculated from the location of the EPFS device.
- Close the main menu.

### 2.3.4 How to setup the bow position

Do as follows to setup the bow position. The AR navigation system uses bow position as reference points for BCR/BCT calculations.

- Click the menu button to open the main menu.
- Click [Service Setting].
- Click [Bow].

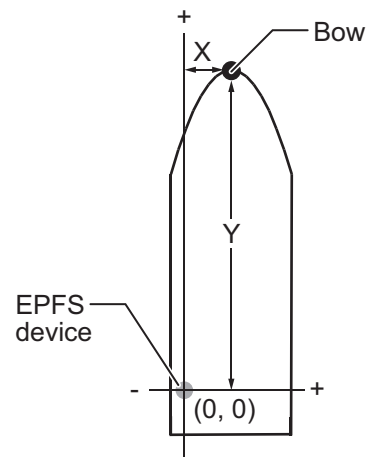
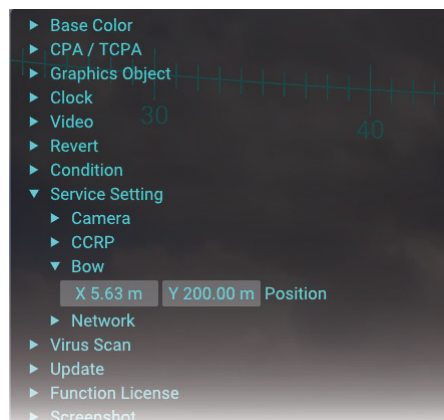

- Adjust the slider bar for [Position] to set the bow position calculated from the location of the EPFS device to use as a reference.
  - [X]: Set the port-starboard (lateral) location of the bow, which is calculated from the location of the EPFS device.
  - [Y]: Set the bow-stern (longitudinal) location of the bow, which is calculated from the location of the EPFS device.
- Close the main menu.

### 2.3.5 How to select the network connected with AR navigation system

Select an appropriate network that the AR navigation system is connected to.

1. Click the menu button to open the main menu.
2. Click [Service Setting].
3. Click [Network].
4. Click [Sentence].
5. Click [Environment].
6. Activate the [Furuno Network] or [Sensor Network] radio button.

- [Furuno Network]: Select when the ECDIS is included in the system configuration.
- [Sensor Network]: Select when the ECDIS is not included in the system configuration.

**Note:** When you activate the [Sensor Network] radio button, the data source setting for TT data must be set to [TTM (TAG Block)] or [TTD/TLB/OSD (TAG Block)]. For details about the TT data source setting, see subsection 2.3.9.

7. Click the [Commit & Reset] button to apply the setting.  
All menu settings on the [Network] menu are applied by clicking the [Commit & Reset] button. Also, the AR navigation system application is automatically reset.

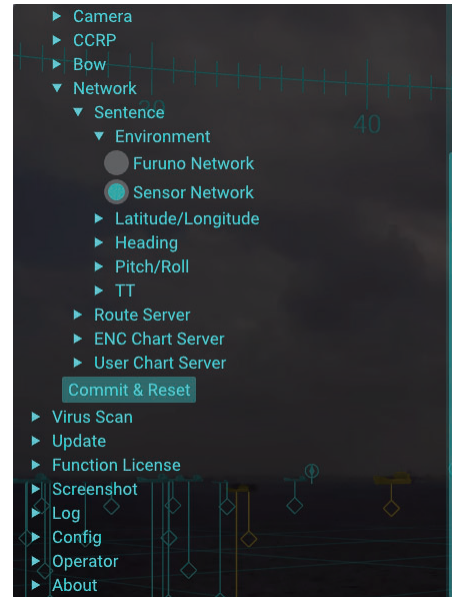

### 2.3.6 How to setup the data source for the position data

Do as follows to setup the data source for the position data.

1. Click the menu button to open the main menu.
2. Click [Service Setting].
3. Click [Network].
4. Click [Sentence].
5. Click [Latitude/Longitude].
6. Enter the SFI (System Function ID) of the equipment that outputs the latitude/longitude sentence in the [SFI] field.
7. Click the [Commit & Reset] button to apply the settings.

All menu settings on the [Network] menu are applied by clicking the [Commit & Reset] button. Also, the AR navigation system application is automatically reset.

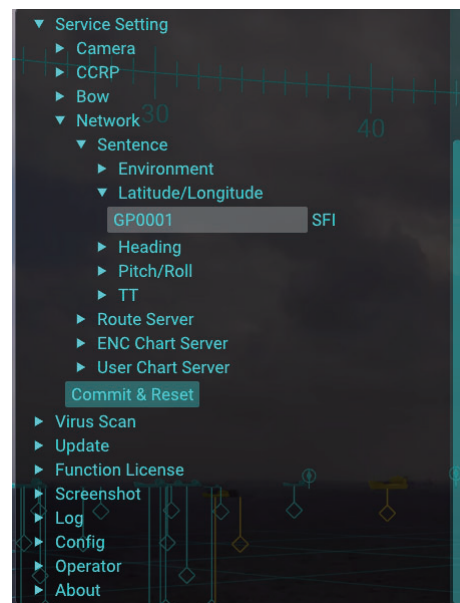

### 2.3.7 How to setup the data source for the heading data

Do as follows to setup the data source for the heading data.

1. Click the menu button to open the main menu.
2. Click [Service Setting].
3. Click [Network].
4. Click [Sentence].
5. Click [Heading].
6. Activate the [THS/HDT] or [ATT] radio button, depending on the sentence to use.  
**Note:** Select the sentence that data accuracy is high.
7. Click the [Commit & Reset] button to apply the settings.  
All menu settings on the [Network] menu are applied by clicking the [Commit & Reset] button. Also, the AR navigation system application is automatically reset.

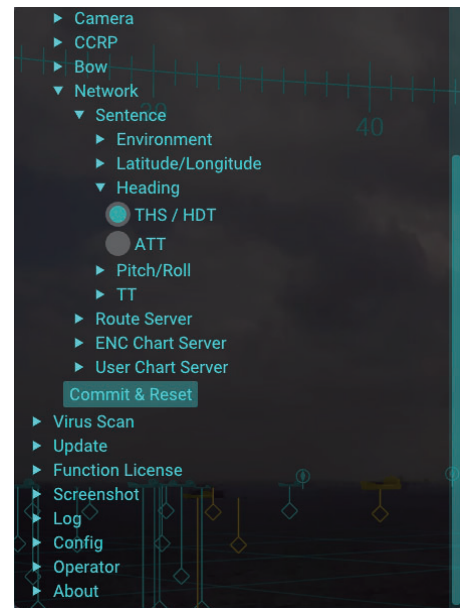

### 2.3.8 How to setup the data source for the pitch/roll data

Do as follows to setup the data source for the pitch/roll data.

1. Click the menu button to open the main menu.
2. Click [Service Setting].
3. Click [Network].
4. Click [Sentence].
5. Click [Pitch/Roll].
6. Enter the SFI (System Function ID) of the equipment that outputs the GPatt sentence in the [SFI] field.  
The AR navigation system is also compatible with the following SFI talkers:
 

• GP	• GL	• GA	• GN
• HE	• HN	• HC	• VD
7. Click the [Commit & Reset] button to apply the settings.  
All menu settings on the [Network] menu are applied by clicking the [Commit & Reset] button. Also, the AR navigation system application is automatically reset.

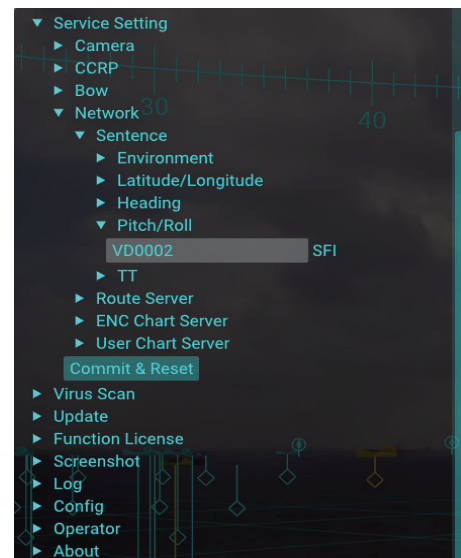

### 2.3.9 How to setup the data source for the TT data

Do as follows to setup the data source for the TT data.

1. Click the menu button to open the main menu.
2. Click [Service Setting].

## 2. INSTALLATION AND INITIAL SETTINGS

3. Click [Network].
4. Click [Sentence].
5. Click [TT].

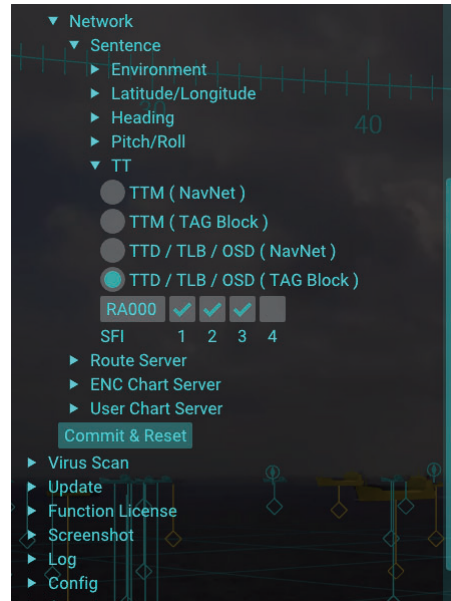
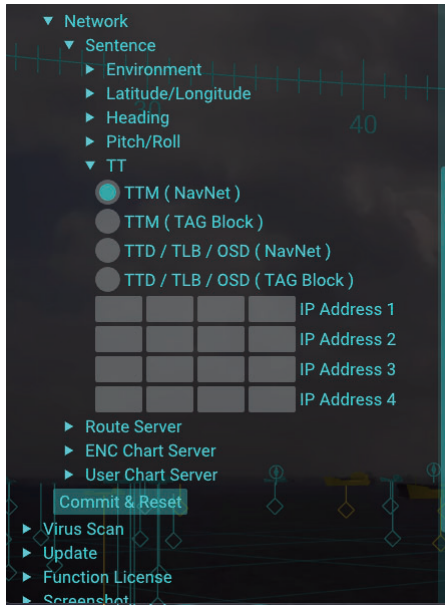

For [TTM (NavNet)] or [TTD/TLB/OSD (NavNet)] For [TTM (TAG Block)] or [TTD/TLB/OSD (TAG Block)]

6. Check the appropriate radio button depending on the sentence for the data source.

Model	ECDIS is included in the system configuration		ECDIS is not included in the system configuration	
	TTM	TTD	TTM	TTD
FAR-14×7	Unconnectable	Unconnectable	[TTM (TAG Block)]	Unavailable
FAR-15×8	[TTM (NavNet)]	[TTD/TLB/OSD (NavNet)]		[TTD/TLB/OSD (TAG Block)]
FAR-2××7				
FAR-2××8				
FAR-3000	[TTM (TAG Block)]	[TTD/TLB/OSD (TAG Block)]		

7. Do as follows according to the radio button that is checked at step 6.
  - For [TTM (NavNet)] or [TTD/TLB/OSD (NavNet)]:  
Enter the IP address(es) for the radar. Be sure to enter all IP addresses for the radar to be assigned as the data source.  
**Note:** All octets for each IP address must be entered. The IP address that has one or more empty strings is invalid.
  - For [TTM (TAG Block)] or [TTD/TLB/OSD (TAG Block)]:  
Check the checkbox(es) for radar SFI (System Function ID). Be sure to check all checkboxes for the radar to be assigned as the data source.
8. Click the [Commit & Reset] button to apply the settings.  
All menu settings on the [Network] menu are applied by clicking the [Commit & Reset] button. Also, the AR navigation system application is automatically reset.

### 2.3.10 How to enter the IP address of the route server

Do as follows to enter the IP address of the route server.

1. Click the menu button to open the main menu.
2. Click [Service Setting].
3. Click [Network].
4. Click [Route Server].
5. Enter the IP address of the ECDIS that outputs the route monitoring data.
6. Click the [Commit & Reset] button to apply the settings.

All menu settings on the [Network] menu are applied by clicking the [Commit & Reset] button. Also, the AR navigation system application is automatically reset.

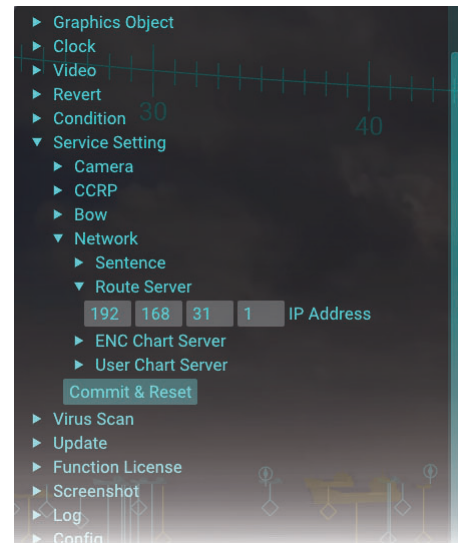

### 2.3.11 How to enter the IP address of the ENC chart server

Do as follows to enter the IP address of the ENC chart server.

1. Click the menu button to open the main menu.
2. Click [Service Setting].
3. Click [Network].
4. Click [ENC Chart Server].
5. Enter the IP address of the ECDIS that outputs the ENC chart data.
6. Click the [Commit & Reset] button to apply the settings.

All menu settings on the [Network] menu are applied by clicking the [Commit & Reset] button. Also, the AR navigation system application is automatically reset.

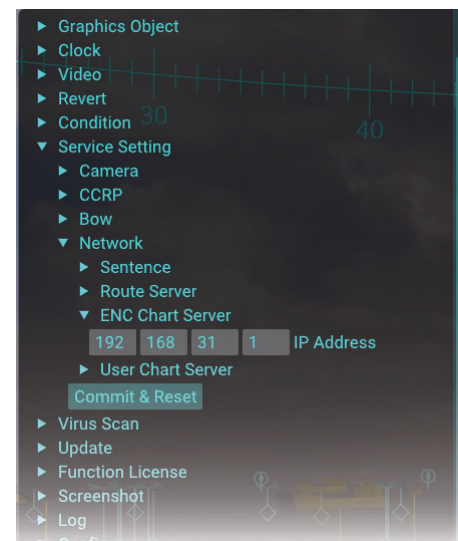

### 2.3.12 How to enter the IP address of the user chart server

Do as follows to enter the IP address of the user chart server.

1. Click the menu button to open the main menu.
2. Click [Service Setting].
3. Click [Network].
4. Click [User Chart Server].
5. Enter the IP address of the ECDIS that outputs the user chart data.
6. Click the [Commit & Reset] button to apply the settings.

All menu settings on the [Network] menu are applied by clicking the [Commit & Reset] button. Also, the AR navigation system application is automatically reset.

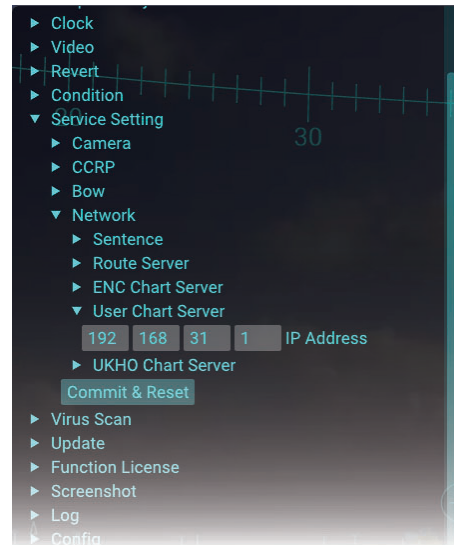

### 2.3.13 How to enter the IP address and port number of the UKHO chart server

Do as follows to enter the IP address of the UKHO chart server.

1. Click the menu button to open the main menu.
2. Click [Service Setting].
3. Click [Network].
4. Click [UKHO Chart Server].  
**Note:** [UKHO Chart Server] appears on the main menu only when UKHO charts display function is activated.
5. Enter the IP address of the ADP PC that outputs the UKHO chart data.
6. Enter the port number to use to communicate with the ADP PC.
7. Click the [Commit & Reset] button to apply the settings.

All menu settings on the [Network] menu are applied by clicking the [Commit & Reset] button. Also, the AR navigation system application is automatically reset.

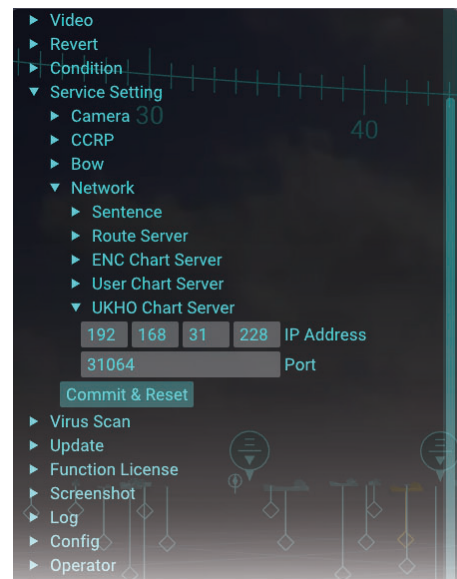



### 2.3.14 Settings for connected equipment

For the satellite speed log, SATELLITE COMPASS™ and ECDIS, set them as shown below to connect with the AR navigation system.

#### Satellite speed log/SATELLITE COMPASS™

Set the transmission rate of the GPatt sentence as short as possible.

**Note:** If the communication load is high, reduce the transmission rate for other sentences or turn some sentences off to reduce the communication load.

#### ECDIS

- Set [Output Route Data Setting] to [File and RMB] and [Output User Chart Data Setting] to [File] on the [TCS] tab of the [Common Installation Setting] menu.

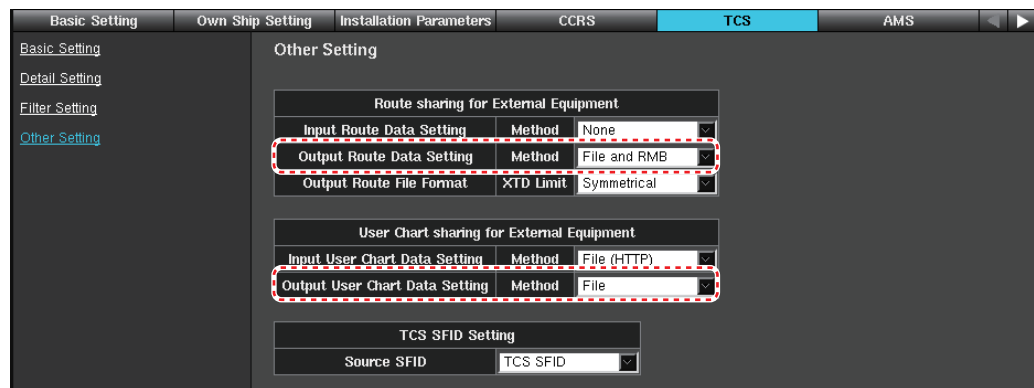

- Check the checkbox for [Output Chart Objects] on the [Basic Setting] tab of the [Common Installation Setting] menu.

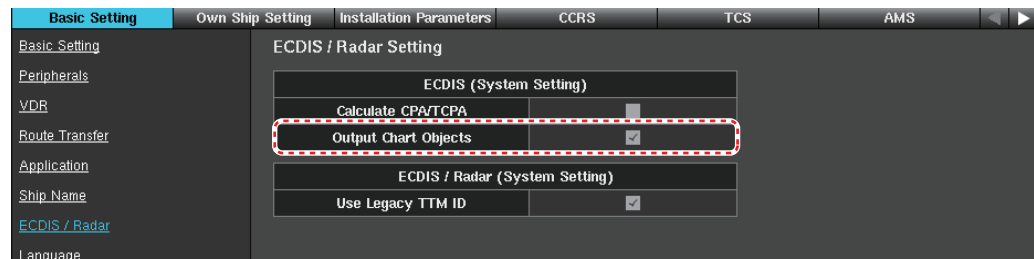

**Note:** The AR navigation system cannot overlay ENC chart objects despite the setting for the [Output Chart Objects] checkbox, if the ECDIS has C-MAP charts installed. Uninstall C-MAP charts to use ENC chart objects.

- Select the equipment ID of the ECDIS that outputs the route data, on the ECDIS menu.

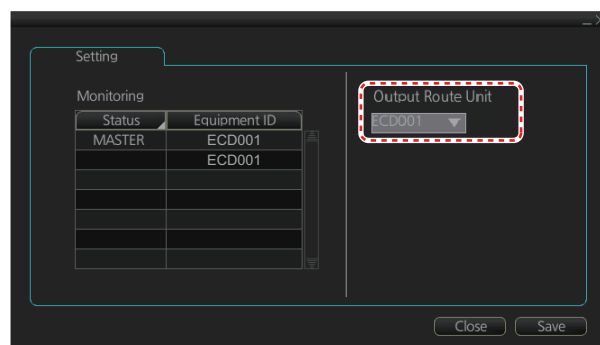

### 2.3.15 MC-3000S settings

When the MC-3000S is included in the system configuration, connect a laptop PC to the MC-3000S via LAN cable to setup the MC-3000S.

#### Preparation

- Laptop PC
  - The web browser must be installed. When the Firefox is used, the version must be “ver. 12.0” or later.
  - The IP address and subnet mask of the port connected with the MC-3000S must be set as follows:  
 IP address: 172.31.16.200  
 Subnet mask: 255.255.0.0
- LAN cable

#### How to access the [Common Installation Setting] menu

1. Connect a laptop PC to the MC-3000S using the LAN cable.
2. Supply the power to the MC-3000S.
3. Activate the web browser on the PC, then enter “172.31.17.108” on the address bar.

The following screen appears.

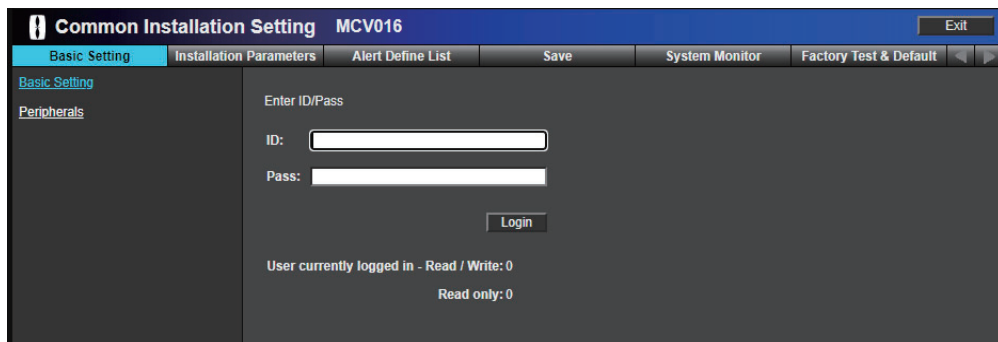

**Note:** “172.31.17.108” is the URL for the factory default. If the Equipment ID for the MC-3000S has changed, enter the URL depending on the Equipment ID, referring to the following table.

Equipment ID	URL	Equipment ID	URL
MCV001	172.31.16.101	MCV009	172.31.16.105
MCV002	172.31.17.101	MCV010	172.31.17.105
MCV003	172.31.16.102	MCV011	172.31.16.106
MCV004	172.31.17.102	MCV012	172.31.17.106
MCV005	172.31.16.103	MCV013	172.31.16.107
MCV006	172.31.17.103	MCV014	172.31.17.107
MCV007	172.31.16.104	MCV015	172.31.16.108
MCV008	172.31.17.104	MCV016 (Factory default)	172.31.17.108

- Enter the ID and password correctly then click the [Login] button.  
The [Common Installation Setting] menu appears.

Sensor Adapter	
Equipment ID	MCV016
Equipment Name	No.16 Sensor Adapter
Equipment Type No.	MC-3000S
Subsystem	
IP Address	Sensor Network
	172 . 31 . 17 . 108

**Note:** After completing the setup on the [Common Installation Setting] menu, click the [Exit] button to logout from the menu, then close the web browser.

### How to save the configuration

If no operating time continues for a while, all settings that are not saved are discarded and the [Common Installation Setting] menu changes to login window. Be sure to save the configuration before aborting the setup.

- Click [Save] on the tab bar.  
When there are some changed menu items that are not saved, “Changed data is not saved yet.” appears on the bottom of the screen.

Save

Check Consistency Import Export

Check Result:

⚠ Changed data is not saved yet. Last Save:06:39 23 Jun 2020 Restore Save

2012 Copyright (c) FURUNO ELECTRIC CO., LTD. All Rights Reserved.

## 2. INSTALLATION AND INITIAL SETTINGS

2. Click the [Check Consistency] button.  
When there is no inconsistency, the [Save] button becomes enabled.

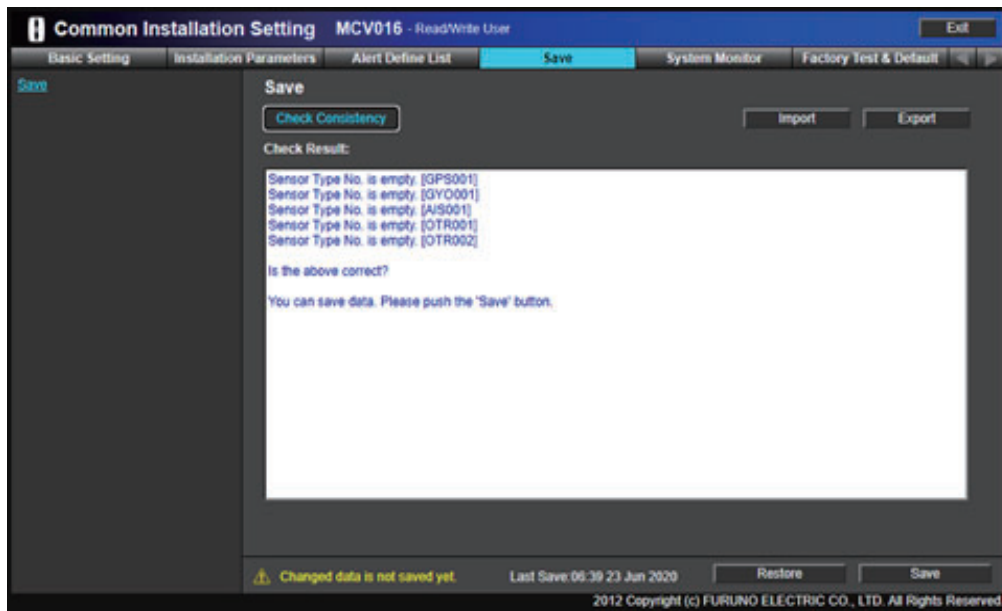

3. Click the [Save] button.  
The following message appears.

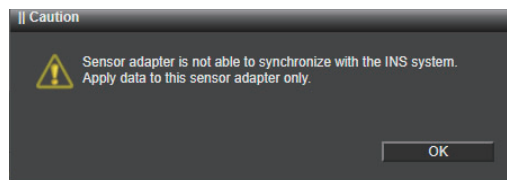

4. Click the [OK] button.

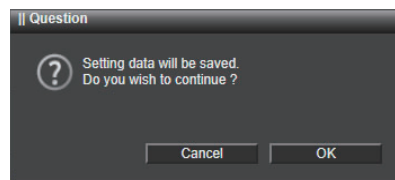

5. Click the [OK] button.  
After completing the saving process, the confirmation message appears.
6. Click the [OK] button to close the message.

### **Activating external navigation equipment**

Activate external navigation equipment connected through MC-3000S to input the sentences to the AR-100M.

1. Click [Installation Parameters] on the tab bar, then select [Sensor Setting] - [GPS Sensor ] from menu on the left of the screen.

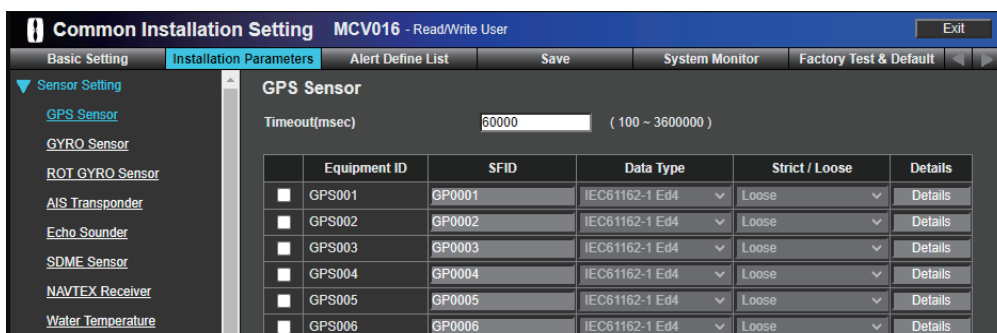

2. Check the checkbox for [GPS001].

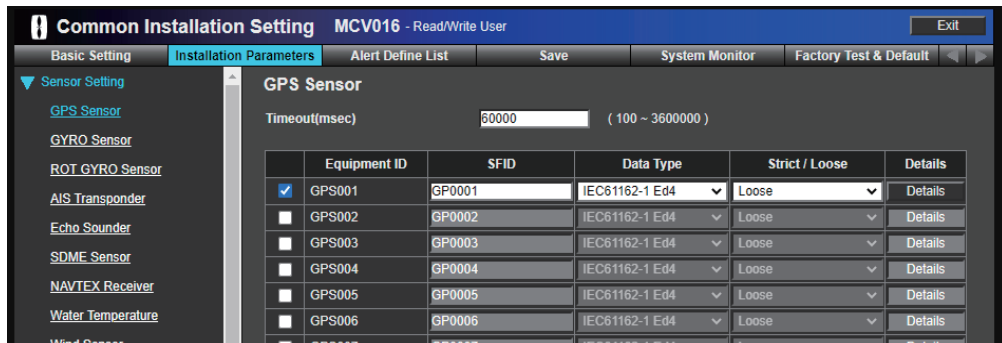

3. Check the checkboxes for the following sensors in a similar manner. For Other Sensor, change the SFID referring to the following table.

Sensor Name	Equipment ID	SFID	Remarks
GPS Sensor	GPS001	GP0001	
GYRO Sensor	GYO001	HE0001	Only when mechanical gyrocompass is connected.
AIS Transponder	AIS001	AI0001	
Other Sensor	OTR001	VD0002	Check applicable checkboxes according to the number of radar connected.
	OTR002	RA0001	
	OTR003	RA0002	
	OTR004	RA0003	
	OTR005	RA0004	

4. Save the configuration, referring to "How to save the configuration" on page 2-27.

**Selecting the port where the sensor is connected**

1. Click [Installation Parameters] on the tab bar, then select [Sensor Adapter] - [No.16 Sensor Adapter] - [Serial Input/Output] from menu on the left of the screen.

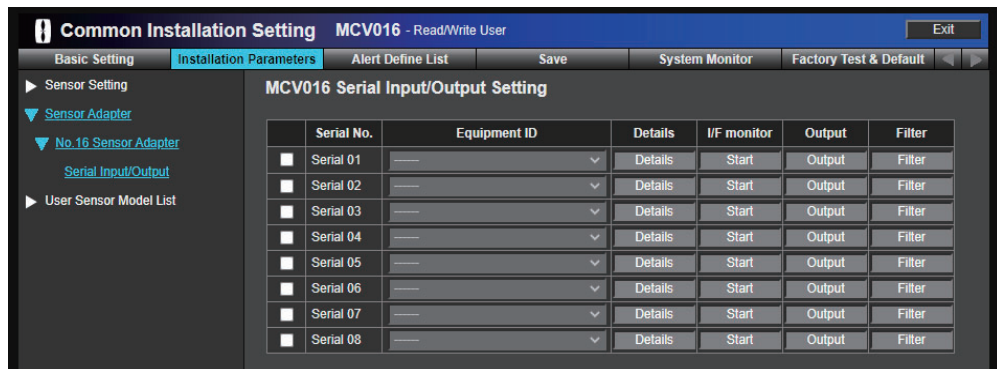

2. Check the checkboxes for the serial port where the sensor is connected ([Serial No.]), then select the Equipment ID of the sensor from the [Equipment ID] drop-down list.

**Note:** The following sensors must be connected to either one of [Serial 01] to [Serial 04], and the baud rate of the serial port must be set to “38400 bps”. Also, the baud rate of the sensor must be set to “38,400 bps”.

- Mechanical gyrocompass
- SATELLITE COMPASS™ /Satellite speed log
- AIS

## 2. INSTALLATION AND INITIAL SETTINGS

The following example indicates that the position sensor is connected to “Serial 01” of the MC-3000S.

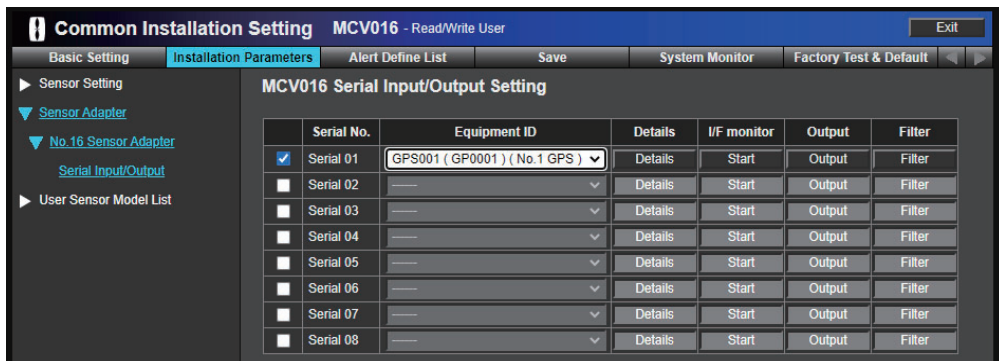

The connector number of the MC-3000S and the corresponding serial port number are shown in the following table.

Connector No.	Serial Port No.	Connector No.	Serial Port No.
J4	Serial 01	J8	Serial 05
J5	Serial 02		Serial 06
J6	Serial 03	J9	Serial 07
J7	Serial 04		Serial 08

- Click the [Details] button for the activated serial port.

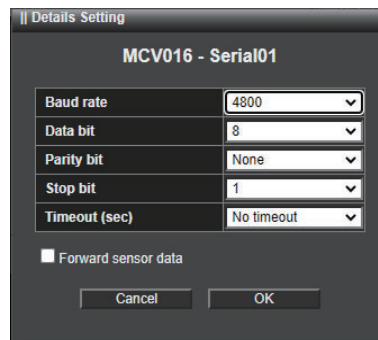

- Set the items referring to the following table, then click the [OK] button.

Menu item	Remarks
[Baud rate]	Sets the baud rate. <b>Note:</b> The maximum baud rate of the serial port is as follows: <ul style="list-style-type: none"> <li>[Serial 01] to [Serial 04]: 38,400 bps</li> <li>[Serial 05] to [Serial 08]: 4,800 bps</li> </ul> However you can select the baud rate more than “4,800 bps” on the menu for [Serial 05] to [Serial 08], the baud rate for [Serial 05] to [Serial 08] must be set to “4800 bps”.
[Data bit]	Sets the number of the data bit.
[Parity bit]	Select [Odd] or [Even] for the parity bit. The parity bit is used in parity error checking to find errors during data transmission. For no parity bit, select [None].
[Stop bit]	Sets the stop bit (last data bit location).
[Timeout (sec)]	When the data is not input during the time set here, time-out alert occurs.
[Forward sensor data]	Check the checkbox to forward data input from the serial port to the sensor adapter. Normally keep the default setting (unchecked).

5. Setup all serial ports, then save the configuration, referring to "How to save the configuration" on page 2-27.
6. After saving the configuration, open the [Serial Input/Output] menu again, then click the [I/F Monitor] button for each serial port to open the serial input/output monitor window.  
Confirm that the MC-3000S receives the sentence from the sensor correctly.

### **Factory default**

To restore the factory default setting, do as follows.

1. Click [Factory Test & Default] on the tab bar.

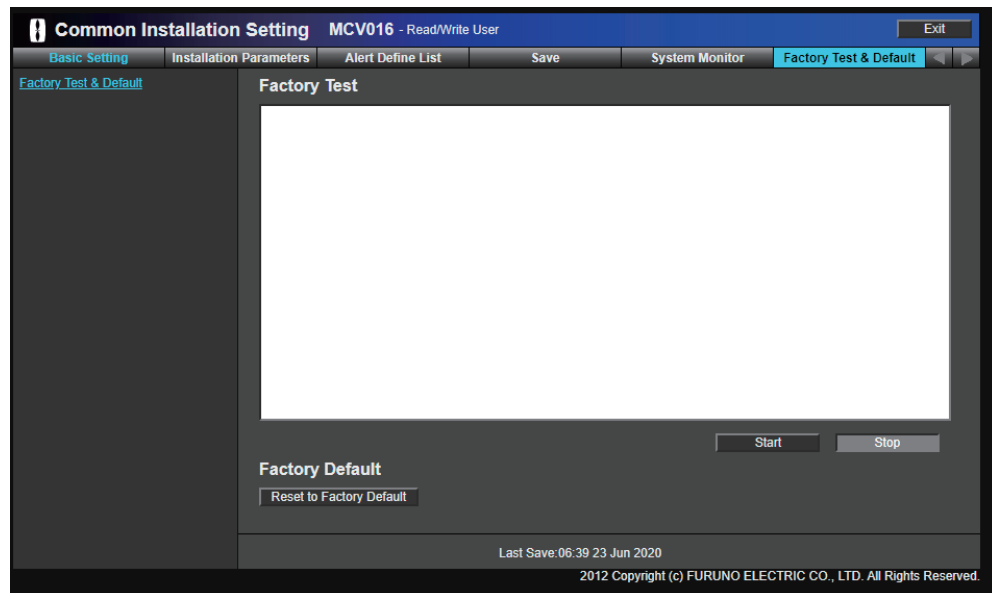

2. Click the [Reset to Factory Default] button on the bottom of the screen.  
The following message appears.

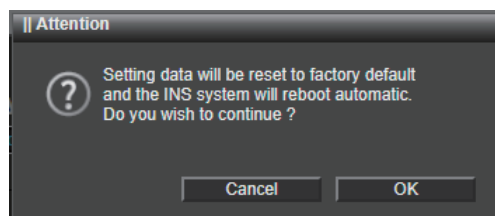

3. Click the [OK] button.  
The MC-3000S restores the factory default. After completing the load of the factory default, the URL for the default Equipment ID appears on the screen.

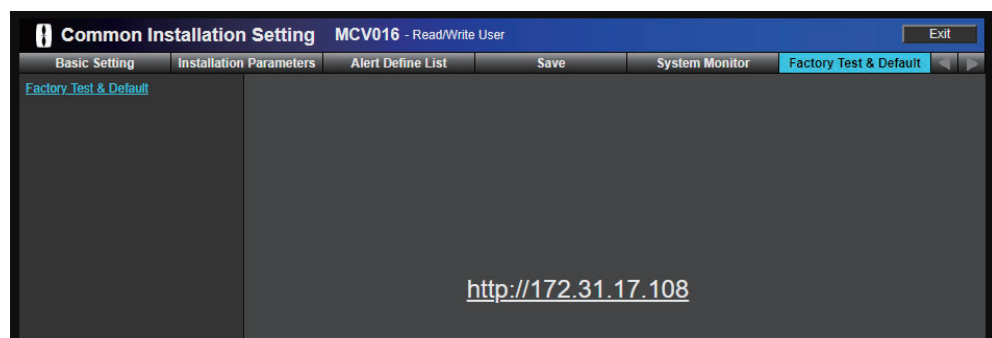

4. Enter "172.31.17.108" on the address bar of the web browser to go back to the login screen of the [Common Installation Setting] menu.

### 2.3.16 Service gateway settings

When connected with the ADP PC where the FURUNO CAST ADP (option software) is installed, use the service gateway (tBOX810-83A-FL) to ensure the network security.

Do as follows to setup the service gateway.

1. Save the configuration file for the service gateway to a PC, then connect the PC to the service gateway as shown in the figure below.

Configuration file name: SGWLite\_Setting\_AR-100M.tar.tar.gz

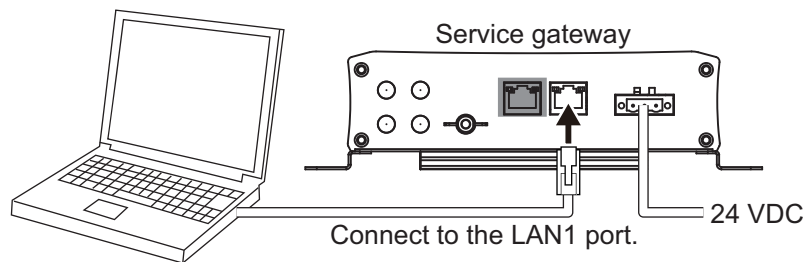

2. Turn on the service gateway, then confirm that the PWR lamp on the front panel lights steadily.

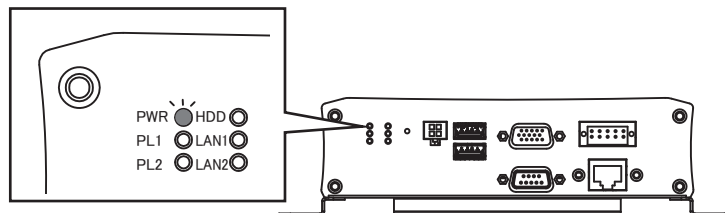

3. Do as follows to change the IP address of the PC to "192.168.31.1".

- 1) Select [Start] button → [Settings] → [Network & Internet] → [Change adapter options].
- 2) Right-click the [Ethernet] icon, then select [Properties].
- 3) Select [Internet Protocol Version 4 (TCP/IPv4)], then click the [Properties] button.
- 4) Enter "192.168.31.1" to [IP address], then click the [OK] button.

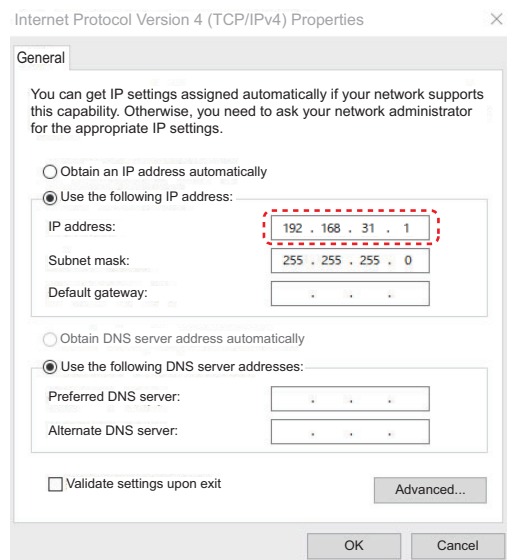

4. Run the web browser (Microsoft Edge) on the PC, then enter the following address on the address bar.
  - http://192.168.31.250



The following login screen appears.

5. Enter the username and password, then click the [Login] button.
6. Select [System] → [Backup/Flash Firmware].

7. Click the [Browse...] button to select the configuration file (SGWLite\_Setting\_AR-100M.tar.tar.gz), then click the [Upload archive...] button.  
The service gateway reboots automatically after the configuration file is applied.
8. Do steps 4 and 5 after the reboot is completed, to confirm that you can access the WebUI screen of the service gateway.
9. Logout from the WebUI screen and turn off the service gateway, then disconnect the PC.

## 2.4 Operation Check

After installing the system and entering initial settings, check the following points to confirm the system operation.

Check point	Details
Error indication	<ul style="list-style-type: none"> <li>• Confirm that there is no error message (in yellow characters) on the main screen.</li> <li>• Confirm that there is no error message (in yellow characters) on the following menus.               <ul style="list-style-type: none"> <li>• Main menu → [Graphics Object] → [Route]</li> <li>• Main menu → [Graphics Object] → [ENC Chart]</li> </ul> </li> </ul> <p>When an error message appears, rectify the error referring to section 3.5.</p>
Sentence	<p>Open the sentence monitor window referring to subsection 3.7.2, and check that the sentences are updated properly.</p> <p><b>Note 1:</b> Acquire a target on the radar to check the sentence for TT data.</p> <p><b>Note 2:</b> Start route monitoring on the ECDIS to check the sentence for waypoint data.</p>
Video image from the IP camera	<p>Check that the video image on the AR navigation system is updated correctly. If a video image error (ex. video freeze) occurs, restart the AR navigation system.</p>
Power operation	<p>Press the power button on the main PC to turn the power off, then press the power button again to turn the power on. After system reboot, the system automatically logs you out from the service technician mode.</p>

# 3. MAINTENANCE

---

## 3.1 Service and Repair

When you need the service and repair for the AR navigation system, read the following information.

- 1) If an abnormality, system error or malfunction occurs in the AR navigation system, be sure to specify the equipment related to the problem before requesting service. The following units are covered by the product warranty.

- Main PC
- IP Camera
- PoE Adapter

The failure of any other unit or accessories (ex. cables, trackball) are not covered by the warranty.

- 2) When the unit that is covered by the warranty has problems, report the detailed information about the problem along with update date and version of the virus definition to the ship's management company. FURUNO receives this information from the ship's management company.
- 3) After receiving problem information, FURUNO sends the replacement unit to the ship's management company. The ship's technicians replace the unit. The replacement by a FURUNO engineer is not covered by the warranty. FURUNO can replace the unit for a fee. However, this service is limited to Japan and Singapore.

## 3.2 Warranty Period

The AR navigation application software, main PC, IP camera and PoE adapter are covered by a one-year warranty from the date that the product is delivered to the place specified by the ship's management company.

The only part of the AR navigation system that is developed by FURUNO is the software application. We install the software application to the commercial product selected by FURUNO and check the software performance before shipment. All units used in the AR navigation system are commercial products. Therefore, the warranty policy for those products is different from other FURUNO products.

When a failure caused by a unit under warranty occurs, we send a replacement unit. Replacement of a unit by a FURUNO engineer is not covered by the warranty. FURUNO can replace the unit for a fee. However, this service is limited to Japan and Singapore.

## 3.3 Recommended Replacement Period

All units used in the AR navigation system are commercial products whose manufacturer's warranty period is one year. We recommend replacement of all units at least every three years to maintain proper performance. Earlier replacement may be necessary depending on use and environment.

## 3.4 Troubleshooting

This section provides simple troubleshooting procedures which the user can follow to restore normal operation. If you cannot restore normal operation, do not attempt to check inside the unit. Any trouble should be referred to a qualified service technician.

Problem	Possible cause	Remedy
You cannot turn the power on.	The power cable is disconnected or damaged.	<ul style="list-style-type: none"> <li>• Check that the power cable is connected correctly.</li> <li>• Check for damaged power cable.</li> </ul>
	Low power voltage	Check battery for proper voltage output.
The [Recovery] screen appears.	The main PC is forcefully terminated while the system is working.	Click the [Restart my PC] button.
	The main PC is forcefully terminated during the shutdown process.	<ol style="list-style-type: none"> <li>1) Press the power button on the main PC to turn the system off.</li> <li>2) After the main PC is turned off, press the power button again to turn the system on.</li> </ol>
The [Automatic Repair] screen appears.	The main PC is forcefully terminated during the startup process.	Click the [Restart] button.
The power LED on the main PC lights but nothing appears on the monitor.	Display brilliance is too low.	Adjust the display brilliance, referring to the operator's manual of the monitor unit. Restart the main PC.
	The video source of the monitor is not correct.	The video source of the monitor should be the video input port that is connected with the main PC.
	SSD cannot be recognized.	<ol style="list-style-type: none"> <li>1) Press the reset button on the main PC to reset the system. The [EFI shell] screen appears after system reset.</li> <li>2) Press the power button on the main PC to turn the system off.</li> <li>3) After the main PC is turned off, press the power button again to turn the system on.</li> </ol>
The [EFI shell] screen appears.	SSD is not recognized.	<ol style="list-style-type: none"> <li>1) Press the power button on the main PC to turn the system off.</li> <li>2) After the main PC is turned off, press the power button again to turn the system on.</li> </ol>
AR navigation objects appear but video image is not shown.	Video image brilliance is too low.	Adjust the video image brilliance, referring to section 1.12.

Problem	Possible cause	Remedy
The video image from the IP camera is abnormal.	The IP camera is not started correctly.	1) Press the power button on the main PC to turn the system off. 2) After the main PC is turned off, press the power button again to turn the system on.
		1) Press the power button on the main PC to turn the system off. 2) Disconnect the LAN cable from the IP camera to stop the power supply. 3) Reconnect the LAN cable to the IP camera. 4) Press the power button again to turn the system on.
The USB device cannot be recognized.	Failure of the main PC may occur.	Restart the main PC.

### 3.5 Error Code/Error Message

When a system error occurs, the corresponding error code and message appear on the center of the display.

The following table shows the error code, message, meaning and remedy for each error.

Error code	Error message	Meaning/Remedy
E0000	Application License Error.	Failed to authenticate the license. Restart the system. If the error is not rectified, contact your dealer.
E0100	Login failed.	Login failed because the operator name/password combination is incorrect. Re-enter the operator name and password. If not rectified, confirm that your keyboard is US English keyboard layout, and turn "Caps Lock" off.
E0200	Update File not found. Please insert USB Memory storing Update File.	The system cannot find the update file. Confirm that the update file is saved to the root directory of the USB flash memory, and the file name or extension is correct: <ul style="list-style-type: none"> <li>• Virus definition update file name must be "mpam-fe.exe".</li> <li>• OS update file extension must be "msu".</li> </ul>
E0202	File copy failed.	File copy failed. Confirm that the USB flash memory is connected correctly.
E0203	Update failed.	Update failed. Confirm that the update file is valid. Check whether the update file is already applied.

### 3. MAINTENANCE

Error code	Error message	Meaning/Remedy
E041x	Sensor Network Error	Network binding error occurs. “x” in the error code indicates the socket number. Confirm the connection between the LAN1 port of the main PC and network hub that relays sensor data. Also, check that the device whose IP address is the same as this system is not connected. If connected, disconnect that device or change the IP address, then restart the system. For how to check the IP address of this system, see section 3.7.
E0421	No Sensor Data. (TO WPT)	No waypoint ID data received. Confirm the connection between the LAN1 port of the main PC and network hub that relays sensor data, and the equipment that outputs waypoint ID data is turned on and works correctly. When the error is not rectified even if the network status is normal, restart the system.
E0422	No Sensor Data. (AIS)	No AIS data received. Confirm the connection between the LAN1 port of the main PC and network hub that relays sensor data, and the equipment that outputs AIS data is turned on and works correctly. When the error is not rectified even if the network status is normal, restart the system.
E0423	No Sensor Data. (L/L)	No position data received. Confirm the connection between the LAN1 port of the main PC and network hub that relays sensor data, and the equipment that outputs position data is turned on and works correctly. When the error is not rectified even if the network status is normal, restart the system.
E0424	No Sensor Data. (HDG)	No heading data received. Confirm the connection between the LAN1 port of the main PC and network hub that relays sensor data, and the equipment that outputs heading data is turned on and works correctly. When the error is not rectified even if the network status is normal, restart the system.
E0425	No Sensor Data. (PITCH/ROLL)	No pitch/roll data received. <ul style="list-style-type: none"> <li>• Confirm the connection between the LAN1 port of the main PC and network hub that relays sensor data, and the equipment that outputs pitch/roll data is turned on and works correctly. When the error is not rectified even if the network status is normal, restart the system.</li> <li>• Check that the SFI of the data source for the pitch/roll data, referring to subsection 2.3.8.</li> </ul>

<b>Error code</b>	<b>Error message</b>	<b>Meaning/Remedy</b>
E0426	No Sensor Data. (COG/SOG)	No COG/SOG data received. Confirm the connection between the LAN1 port of the main PC and network hub that relays sensor data, and the equipment that outputs COG/SOG data is turned on and works correctly. When the error is not rectified even if the network status is normal, re-start the system.
E0427*	No Sensor Data. (CTW/STW1)	No CTW/STW data received. The number in the brackets indicates radar number. Confirm the connection between the LAN1 port of the main PC and network hub that relays sensor data, and the equipment that outputs CTW/STW data is turned on and works correctly. When the error is not rectified even if the network status is normal, restart the system.
E0428*	No Sensor Data. (CTW/STW2)	
E0429*	No Sensor Data. (CTW/STW3)	
E042A*	No Sensor Data. (CTW/STW4)	
E042F	No Sensor Data. (UTC)	No date data received. Confirm the connection between the LAN1 port of the main PC and network hub that relays sensor data, and the equipment that outputs time data is turned on and works correctly. When the error is not rectified even if the network status is normal, restart the system.
E0431	No Sensor Data. (TO WPT)	Waypoint ID data without the specified format data received. Confirm that the equipment that outputs waypoint ID data is turned on and works correctly.
E0432	No Sensor Data. (AIS)	AIS data without the specified format data received. Confirm that the equipment that outputs AIS data is turned on and works correctly.
E0433	No Sensor Data. (L/L)	Position data without the specified format data received. Confirm that the equipments that outputs position data is turned on and works correctly.
E0434	No Sensor Data. (HDG)	Heading data without the specified format data received. Confirm that the equipment that outputs heading data is turned on and works correctly.
E0435	No Sensor Data. (PITCH/ROLL)	Pitch/roll data without the specified format data received. Confirm that the equipment that outputs pitch/roll data is turned on and works correctly.
E0436	No Sensor Data. (COG/SOG)	COG/SOG data without the specified format data received. Confirm that the equipment that outputs COG/SOG data is turned on and works correctly.

### 3. MAINTENANCE

<b>Error code</b>	<b>Error message</b>	<b>Meaning/Remedy</b>
E0437*	No Sensor Data. (CTW/STW1)	CTW/STW data without the specified format data received. The number in the brackets indicates radar number. Confirm that the equipment that outputs CTW/STW data is turned on and works correctly.
E0438*	No Sensor Data. (CTW/STW2)	
E0439*	No Sensor Data. (CTW/STW3)	
E043A*	No Sensor Data. (CTW/STW4)	
E043F	No Sensor Data. (UTC)	Date data without the specified format data received. Confirm that the equipment that outputs date data is turned on and works correctly.
E0441	No Sensor Data. (TO WPT)	Invalid waypoint ID data received. Confirm that the equipment that outputs waypoint ID data works correctly.
E0443	No Sensor Data. (L/L)	Invalid position data received. Confirm that the equipment that outputs position data works correctly.
E0444	No Sensor Data. (HDG)	Invalid heading data received. Confirm that the equipment that outputs heading data works correctly.
E0445	No Sensor Data. (PITCH/ROLL)	Invalid pitch/roll data received. Confirm that the equipment that outputs pitch/roll data works correctly.
E0446	No Sensor Data. (COG/SOG)	Invalid COG/SOG data received. Confirm that the equipment that outputs COG/SOG data works correctly.
E0447*	No Sensor Data. (CTW/STW1)	Invalid CTW/STW data received. The number in the brackets indicates radar number. Confirm that the equipment that outputs CTW/STW data works correctly.
E0448*	No Sensor Data. (CTW/STW2)	
E0449*	No Sensor Data. (CTW/STW3)	
E044A*	No Sensor Data. (CTW/STW4)	
E044F	No Sensor Data. (UTC)	Invalid date data received. Confirm that the equipment that outputs date data works correctly.
E0520	No Camera Data	No camera data received. Check the connection between the LAN 2 port on the main PC and PoE adapter and IP camera. Confirm that power is supplied to the PoE adapter. Also, check that the device whose IP address is the same as this system is not connected. If connected, disconnect that device or change the IP address, then restart the system. For how to check the IP address of this system, see section 3.7.
E0530	No Camera Data	Communication timeout with the IP camera. Check the connection between the LAN 2 port on the main PC and PoE adapter and IP camera. Confirm that power is supplied to the PoE adapter.
E0601	Route Network Error.	The system cannot connect with the route data server. Check the connection between the LAN1 port on the main PC and ECDIS.



Error code	Error message	Meaning/Remedy
E0602	Excessive Route Data.	More than 200 waypoints are included in a route. Use the route data where the number of waypoints is 200 or less.
E0701	ENC Chart Network Error.	The system cannot connect with the ENC chart server. Check the connection between the LAN1 port on the main PC and ECDIS.
E0702	ENC Chart Network Error.	The ENC chart file does not exist on the server. Check that the position data is input to the ECDIS.
E0703	ENC Chart User Permit not found.	The system cannot find the ENC user permit. Check that the ENC dongle is inserted to the main PC. When the error keeps occurring for one minute or more after checking the ENC dongle connection, restart the system.
E0704	ENC Chart Decode Error.	Decode error occurs. Confirm that the user permit is the same as the one on the ECDIS connected to this system and the one stored to the ENC dongle. You can confirm the user permit that is used in this system from the main menu → [Graphics Object] → [ENC Chart].
E0705	Excessive ENC Chart Data.	There are too many data in the ENC chart. This system cannot show the ENC chart objects while this error occurs.
E0802	User Chart File not found. Please insert USB Memory storing User Chart File.	The system cannot find the user chart file. Confirm that the file is saved to the root directory of the USB flash memory.
E0804	File lost.	User chart file is lost. Confirm that the USB flash memory is inserted to the main PC.
E0806	Invalid User Chart Data.	Invalid user chart file is used. Use the user chart file exported from the ECDIS.
E0807	Excessive User Chart Data.	<p>There are too many data in the user chart file. Use a user chart file with up to 100,000 vertexes and 10,000 objects.</p> <p><u>Example: User chart data with 10 triangle objects</u></p> <ul style="list-style-type: none"> <li>• Total number of vertexes: 3 vertexes (triangle) × 10 objects = 30 vertexes</li> <li>• Total number of objects: Number of triangle object = 10 objects</li> </ul>
E0808	Excessive User Chart File Size	The capacity of the user char file exceeds 20 MB. Use the user chart file whose capacity is less than 20 MB.
E0809	User Chart Network Error	The system cannot connect with the user chart server. Check the connection between the LAN1 port on the main PC and the ECDIS.

### 3. MAINTENANCE

<b>Error code</b>	<b>Error message</b>	<b>Meaning/Remedy</b>
E0900	Update File not found. Please insert USB Memory storing Update File.	The system cannot find the application update file. Confirm that the update file is saved to the root directory of the USB flash memory.
E0901	Not newer version.	The software version of the application update file is same as current version, or older than the current version. Use the latest update file.
E0902	File copy failed.	File copy failed. Confirm that the USB flash memory is connected correctly and update file name is not changed from the original file name.
E0B00	Low Memory. Please restart the system.	The remaining capacity of the memory is insufficient. Restart the system.
E0C01	Storage shortage.	The disk capacity is insufficient to take a screenshot. Delete unnecessary screenshots referring to subsection 1.14.3. You can confirm the disk capacity status from the main menu → [Screenshot].
E0C02	USB Memory not found.	The USB flash memory to save screenshot files cannot be detected. Insert the USB flash memory to the main PC.
E0C03	USB Memory shortage.	The disk capacity of the USB flash memory is insufficient to copy screenshots. Make sure that there is enough space in the USB flash memory.
E0C04	File copy failed.	File copy of screenshots failed. Insert the USB flash memory to the main PC.
E0D01	USB Memory not found.	The USB flash memory to save log files cannot be detected. Insert the USB flash memory to the main PC.
E0D02	USB Memory shortage.	The disk capacity of the USB flash memory is insufficient to copy log files. Make sure that there is enough space in the USB flash memory.
E0D03	File copy failed.	File copy of log files failed. Insert the USB flash memory to the main PC.
E0F00	USB Memory not found.	The USB flash memory to save the configuration file cannot be detected. Insert the USB flash memory to the main PC.
E0F01	File copy failed.	Export of the configuration file failed. Insert the USB flash memory to the main PC.
E1000	Config File not found. Please insert USB Memory storing Config File.	The system cannot find the configuration file. Confirm that the configuration file is saved to the USB flash memory.
E1001	File copy failed.	Import of the configuration file failed. Insert the USB flash memory to the main PC.
E1002	Invalid File.	The system detects an invalid configuration file. Use the configuration file that exported from this system.

Error code	Error message	Meaning/Remedy
E1003	Not same or older version.	The system cannot import the configuration file because the file is exported from newer software version than the current version.
E1102	Invalid Code.	An Invalid activation code is entered. Check if the code is valid, then enter the code correctly.
E1103	Used Code.	Used activation code is entered. Enter a new, unused code.
E1105	To deactivate, it is necessary to UTC Data.	To deactivate the UKHO charts display function, it is necessary to receive UTC data. Input the UTC data, then retry deactivating.
E1201	UKHO Chart Network Error.	The system cannot connect with the UKHO chart server. Check the connection between the LAN1 port on the main PC and the ECDIS.
E1202	UKHO Chart Network Error.	The UKHO chart server does not work properly. Check the operation of the ADP PC.
E1203	Invalid UKHO Chart Request.	The system detects an invalid data request.
E1204	Invalid UKHO Chart Data.	Invalid UKHO chart data is received. If this error is not rectified for a long time, restart the ADP and ADP PC.

\*: Not occurred when the [TTM (NavNet)] or [TTM (TAG Block)] radio button is checked at subsection 2.3.9.

## 3.6 How to Restore Default Settings

Do as follows to restore all default user settings.

1. Click the menu button to open the main menu.
2. Click [Revert].
3. Click the [Revert User Setting to Default & Reset] button.  
The following confirmation message appears.

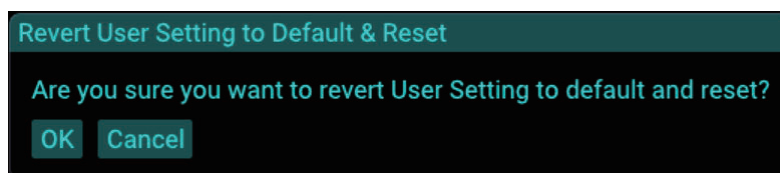
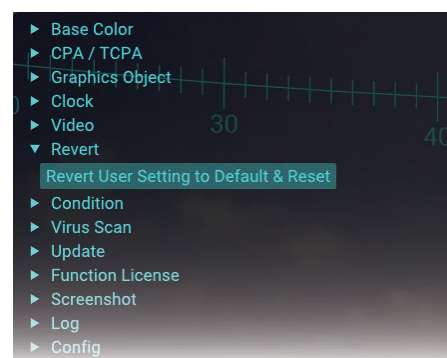

4. Click the [OK] button to restore all default user settings.

## 3.7 System Information

### 3.7.1 How to show the system information

Do as follows to show the system information.

1. Click the menu button to open the main menu.
2. Click [Condition].  
The system information is shown on the main menu.

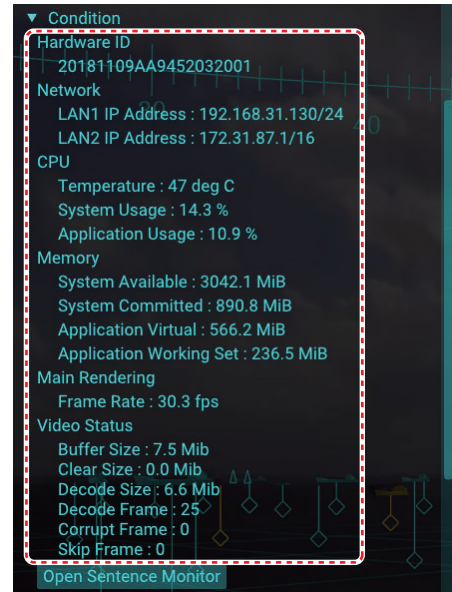

Item	Remarks
Hardware ID	
Hardware ID	Hardware ID
Network	
LAN1 IP Address	IP address for the LAN 1 port
LAN2 IP Address	IP address for the LAN 2 port
CPU	
Temperature	CPU temperature
System Usage	CPU usage for the system
Application Usage	CPU usage for the AR navigation system application
Memory	
System Available	Memory capacity available with the system
System Committed	Memory usage for the system
Application Virtual	Virtual memory usage for the AR navigation system application
Application Working Set	Physical memory usage for the AR navigation system application
Main Rendering	
Frame Rate	Frame rate for AR display
Video Status	
Buffer Size	Buffer data amount for the video image received from the IP camera
Clear Size	Buffer data amount that is cleared in one second.
Decode Size	Data amount that is decoded in one second
Decode Frame	The number of decoded frames per one second
Corrupt Frame	The number of corrupted frames during one second decoding
Skip Frame	The number of skipped frames during one second decoding

3. Close the main menu.

### 3.7.2 Sentence monitor window

You can check if the AR navigation system is properly receiving sentence information. Do as follows to open the sentence monitor window.

1. Click the menu button to open the main menu.
2. Click [Condition].
3. Click the [Open Sentence Monitor] button.  
The sentence monitor window appears. The sentences on the window are updated in real time. To pause the window and confirm the contents, click the [Pause] button. The [Pause] button is changed to [Play] button while pausing the window. To restart the sentence monitor, click the [Play] button.

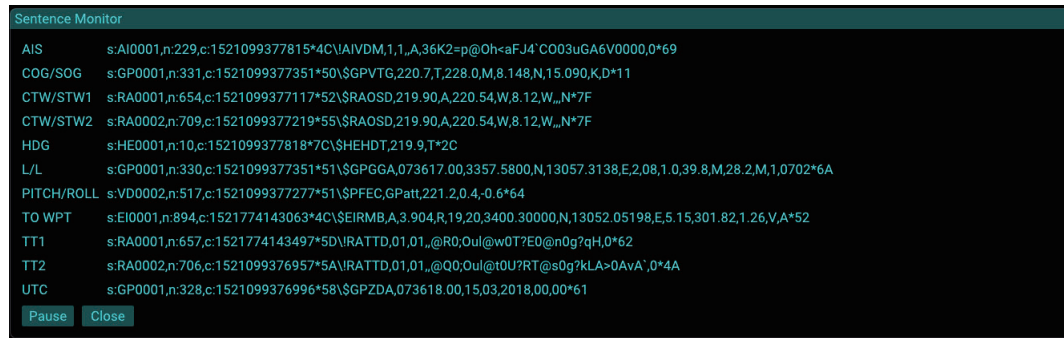

4. Click the [Close] button to close the sentence monitor window.
5. Close the main menu.

## 3.8 How to Perform the Virus Scan

You can perform the virus scan using the equipped anti-virus software. The virus definitions and related files must be kept up-to-date. For how to update the virus definitions, see section 3.10.

**Note:** The virus scan may take more than 30 minutes, and the scan cannot be aborted. Also, the system reboot is needed after completing the scan.

1. Click the menu button to open the main menu.
2. Click [Virus Scan].

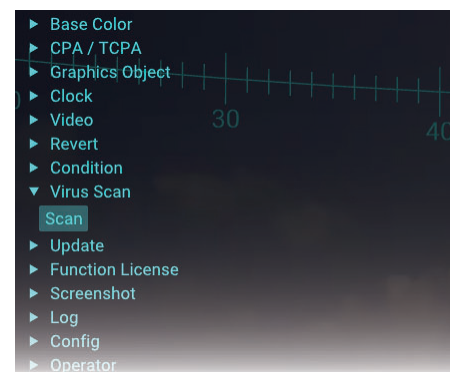

3. Click the [Scan] button.  
The message shown in the figure to the right appears.

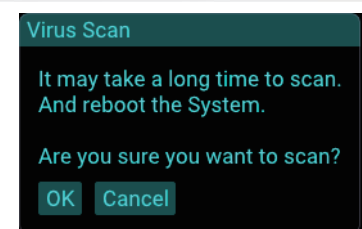

### 3. MAINTENANCE

- Click the [OK] button to start the virus scan.  
The message shown below-left appears during the virus scan. After completing the scan, the result window shown below-right appears.

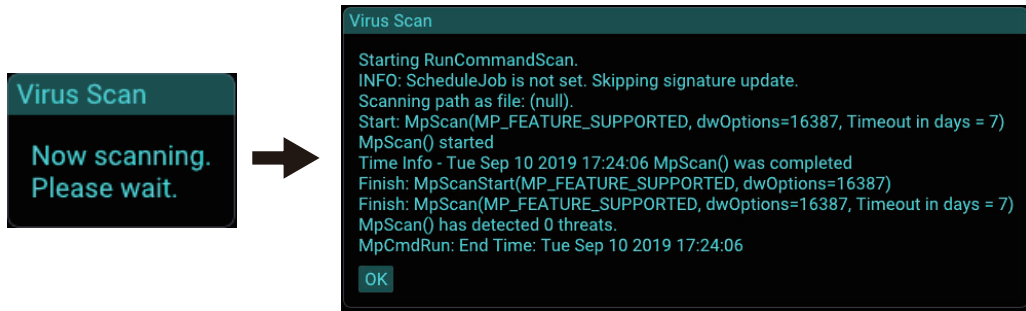

- Click the [OK] button to close the result window.  
The message shown in the figure to the right appears.
- Click the [OK] button to restart the system.  
The system is restarted and the normal startup screen appears.

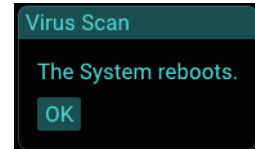

**Note:** If the anti-virus software cannot remove a detected threat(s) (virus(es)), do as follows:

- Press the power button to turn the power off.
- Disconnect the power and LAN cables from the main PC.
- Contact your dealer to request service.

## 3.9 How to Update the AR Navigation System Application

Do as follows to update the AR navigation system application.

**Note:** The system keeps previous settings after updating the application. However, menu items whose setting range or unit is changed due to the application update are reverted to their default settings.

- Copy the application update file (file name: 8759004-xx.xx-Revxxxx.zip) to a USB flash memory then insert the flash memory to the USB port on the main PC.

**Note:** The application update file must be saved to the root directory of the USB flash memory. **Do NOT unzip the update file.**

- Click the menu button to open the main menu.
- Click [Update].



- Click the [Application Update] button.  
The following message appears.

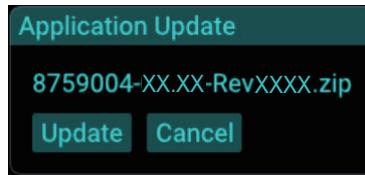

**Note 1:** If the application update file is not saved in the USB flash memory, the message shown in the figure to the right appears. Confirm that the application update file is saved correctly in the flash memory.



**Note 2:** If the software version of the application update file is same as current version, or older than the current version, the message shown in the figure to the right appears. Use the latest update file.

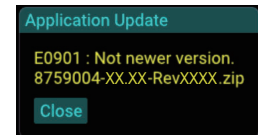

- Click the [Update] button.  
The confirmation message as shown in the figure to the right appears.

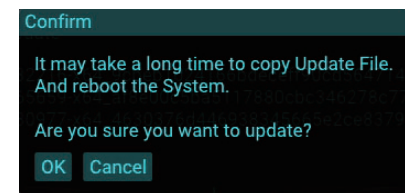

- Click the [OK] button.  
The message shown below-left appears during the update. After completing the update, the confirmation message shown below-right appears.

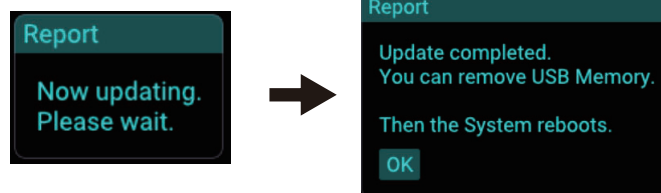

**Note:** Do not remove the USB flash memory during the update. If the flash memory is removed, the message shown in the figure to the right appears. Close the message and retry updating after inserting the USB flash memory.

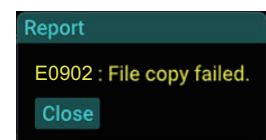

- Disconnect the USB flash memory, then click the [OK] button to reboot the system.  
The system is restarted automatically to launch the updated application.

## 3.10 How to Update Virus Definition

Do as follows to update the virus definition.

- Download the latest virus definition file for Microsoft Defender Antivirus for Windows 10 and Windows 8.1 (64 bit) from the following web site.
  - <https://www.microsoft.com/en-us/wdsi/definitions>
- Copy the virus definition (file name: mpam-fe.exe) to a USB flash memory then insert the flash memory to the USB port on the main PC.

**Note:** The virus definition must be saved to the root directory of the USB flash memory.

### 3. MAINTENANCE

3. Click the menu button to open the main menu.
4. Click [Update].

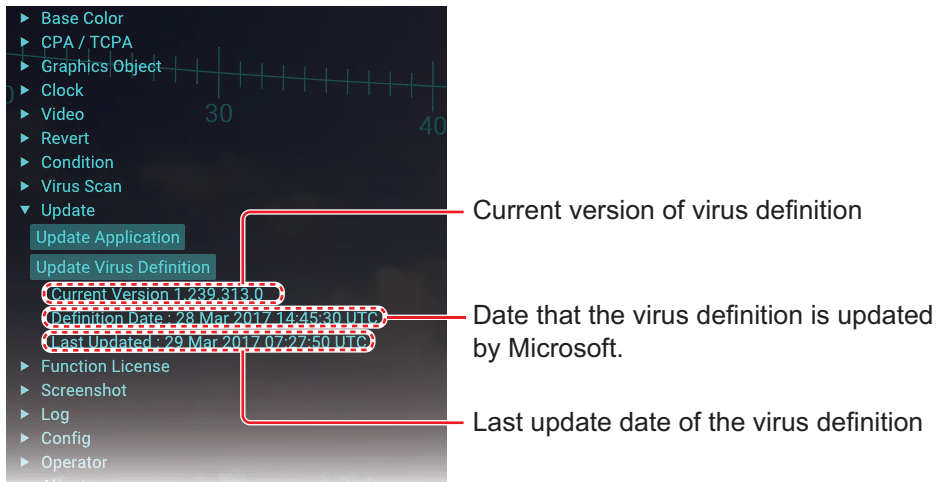

5. Click the [Update Virus Definition] button.  
The window as shown in the figure to the right appears.

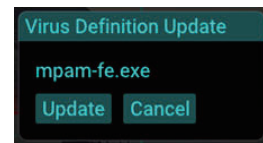

**Note:** If the virus definition file is not saved in the USB flash memory, the message shown in the figure to the right appears. Confirm that the virus definition file is saved correctly in the flash memory.

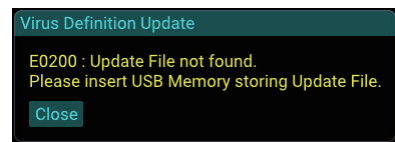

6. Click the [Update] button.  
The confirmation message as shown in the figure to the right appears.

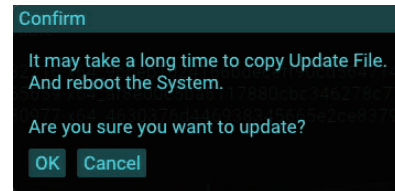

7. Click the [OK] button.  
The progress bar is shown while copying the definition file. After completing the file copy, the confirmation message shown below-right appears.

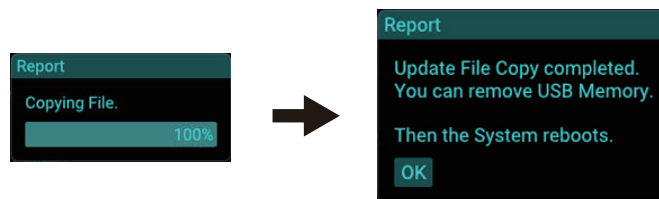

**Note:** Do not remove the USB flash memory during the copying. If the flash memory is removed, the message shown in the figure to the right appears. Close the message and retry updating the virus definition after inserting the USB flash memory.

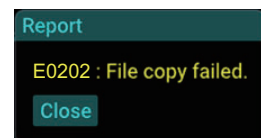

8. Disconnect the USB flash memory, then click the [OK] button to reboot the system.  
The system is restarted automatically to update the virus definition. The message shown in the figure to the right appears while updating the defini-

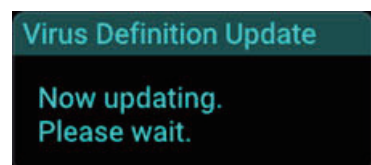



tion. After the updating is completed, the system is restarted automatically, then the normal startup screen appears.

**Note:** If the updating fails, the message shown in the figure to the right appears. Close the message and retry updating the virus definition.

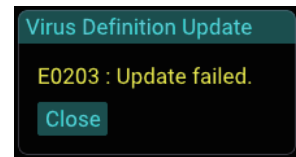

## 3.11 How to Update the Operating System

Do as follows to update the operating system.

1. Copy the operating system update file (file extension: msu) to a USB flash memory then insert the flash memory to the USB port on the main PC.

**Note 1:** The operating system update file must be saved to the root directory of the USB flash memory.

**Note 2:** The following characters and symbols are available for the file name. Do not use other characters and symbols.

- Allowed characters: Alphanumeric characters
- Allowed symbols: ! #\* \$ % & ' ( ) + , - . ; = @ [ ] ^ \_ ` { } ~ °  
\*: Multiple same characters (example: ##) cannot be used.

2. Login as a service technician, referring to subsection 2.3.1.

3. Click [Update].

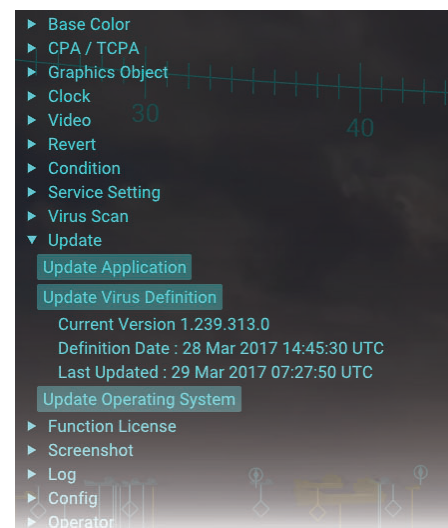

4. Click the [Update Operating System] button. The following message appears.

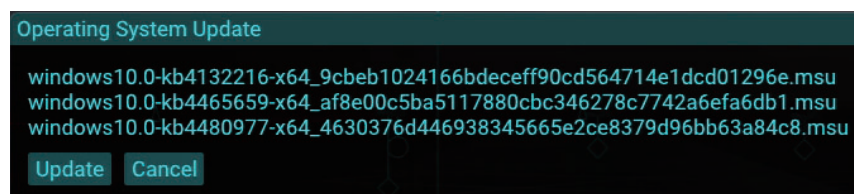

**Note:** If the operating system update file is not saved in the USB flash memory, the message shown in the figure to the right appears. Confirm that the operating system update file is saved correctly in the flash memory.

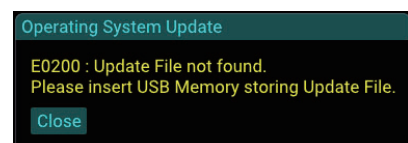

### 3. MAINTENANCE

- Click the [Update] button.  
The confirmation message as shown in the figure to the right appears.

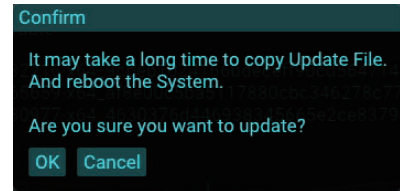

- Click the [OK] button.  
The progress bar is shown while copying the update file. After completing the file copy, the system is restarted automatically to update the operating system. The message shown below-right appears while updating the operating system. After the updating is completed, the system is restarted automatically, then the normal startup screen appears.



**Note 1:** Do not remove the USB flash memory during the file copying. If the flash memory is removed, the message shown in the figure to the right appears. Close the message and retry updating the operating system.

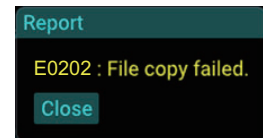

**Note 2:** If the update fails, the message shown in the figure to the right appears. Close the message and retry updating the operating system.

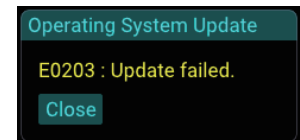

- Disconnect the USB flash memory.

## 3.12 How to Copy Log Files

You can copy log files that are saved in the main PC to a USB flash memory.

- Insert a USB flash memory to the USB port on the main PC.
- Click the menu button to open the main menu.
- Click [Log].

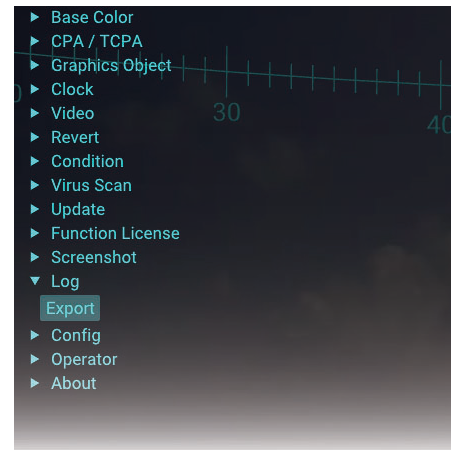

- Click the [Export] button.  
The [Log Export] window appears.
- Select the number of the application log file at the [Application Log] field.  
Typical Period changes according to the setting of [Application Log] and indicates the number of days for log files.

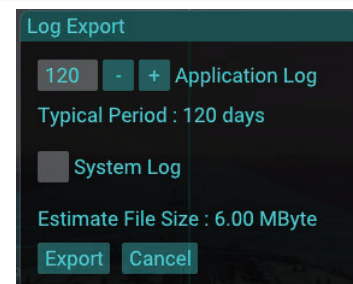

6. Check the checkbox of [System Log] to copy the system log file.  
[Estimate File Size] indicates the estimated file size of the compressed log file.
7. Click the [Export] button.

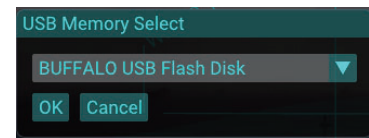

**Note:** If the USB flash memory cannot be detected, the error message shown in the figure to the right appears. Insert the USB flash memory to the main PC.

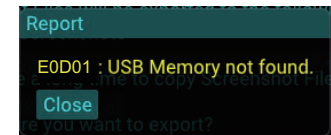

8. Select the USB flash memory as saving destination from the drop-down list.
9. Click the [OK] button to start the copy of the log files.  
The message shown below-left appears while copying log files. After completing the file copy, the confirmation message shown below-right appears.

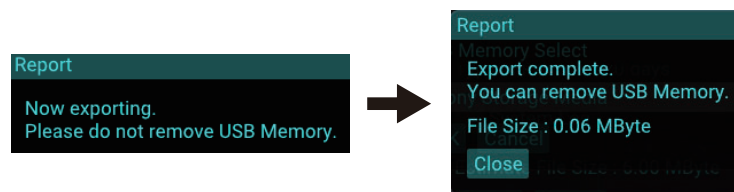

**Note 1:** If the disk capacity of the USB flash memory is insufficient to copy log files, the error message shown in the figure to the right appears. Make sure that there is enough space in the USB flash memory.

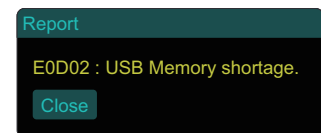

**Note 2:** Do not remove the USB flash memory during the copying. If the flash memory is removed, the message shown in the figure to the right appears. Close the message and retry copying log files after inserting the USB flash memory.

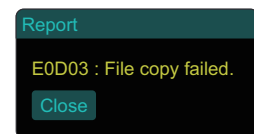

10. Click the [Close] button.

## 3.13 Configuration File

### 3.13.1 How to export the current configuration file to a USB flash memory

Do as follows to export the current configuration data to a USB flash memory.

1. Insert a USB flash memory to the USB port on the main PC.
2. Click the menu button to open the main menu.
3. Click [Config].

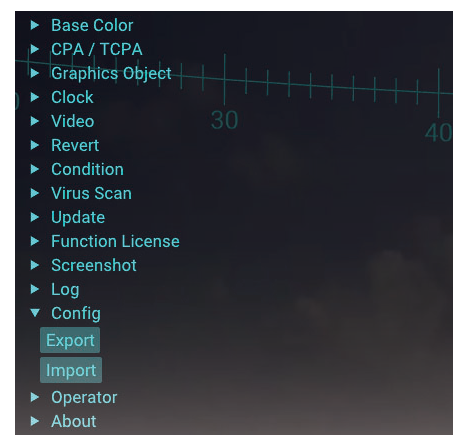

### 3. MAINTENANCE

- Click the [Export] button.

**Note:** If the USB flash memory cannot be detected, the error message shown in the figure to the right appears. Insert the USB flash memory to the main PC.

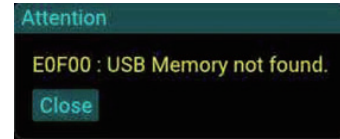
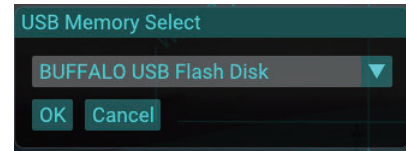

- Select the USB flash memory as saving destination from the drop-down list.
- Click the [OK] button to start exporting the configuration file. The message shown below-left appears while exporting. After completing the file export, the confirmation message shown below-right appears.

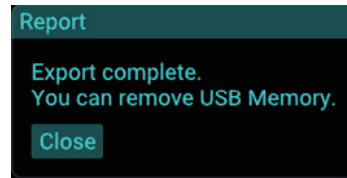
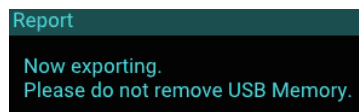

**Note:** Do not remove the USB flash memory during the export. If the flash memory is removed, the message shown in the figure to the right appears. Close the message and retry exporting the configuration file after inserting the USB flash memory.

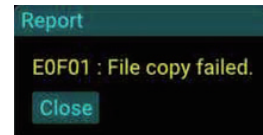

- Close the main menu.

### 3.13.2 How to import a configuration file

Do as follows to import the configuration file exported at section 3.13.1.

- Insert the USB flash memory that contains the configuration file (file extension: zip) to the USB port on the main PC.

**Note: Do NOT unzip the configuration file.**

- Click the menu button to open the main menu.
- Click [Config].
- Click the [Import] button.

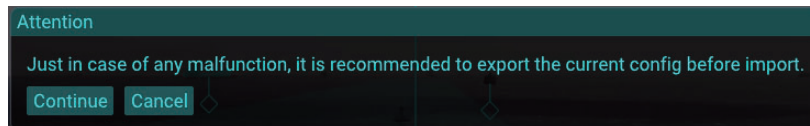

**Note:** You cannot restore the current configuration file after importing the file. It is recommended to export the current configuration file before importing the file.

- Click the [Continue] button.

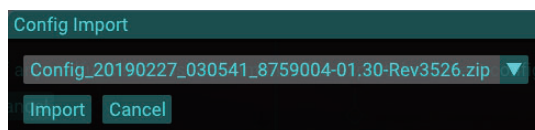

**Note:** If the configuration file is not saved in the USB flash memory, the message shown in the figure to the right appears. Confirm that the configuration file is saved correctly in the flash memory.

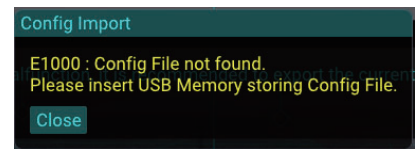

6. Select the configuration file to be imported from the drop-down list.
7. Click the [Import] button.

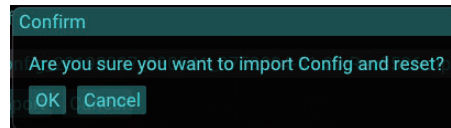

**Note 1:** If the configuration file selected at step 6 cannot be found, the message shown in the figure to the right appears. Confirm that the configuration file is saved correctly in the flash memory.

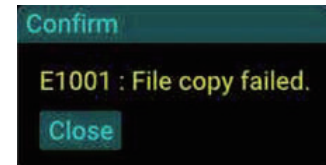

**Note 2:** If the configuration file is invalid, the message shown in the figure to the right appears. Use the configuration file exported from this system.

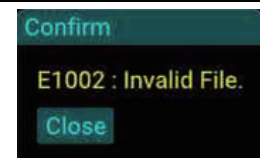

**Note 3:** If the configuration file is exported from newer software version than the current version, the following message appears. Use the configuration file exported from the same or older than the current version.

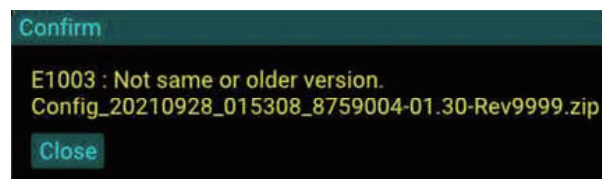

8. Click the [OK] button. The message shown below-left appears while importing. After completing the file import, the confirmation message shown below-right appears.

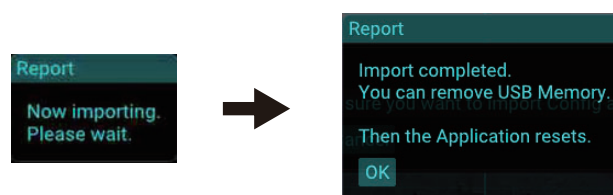

**Note:** If the file import of the configuration file fails, the message shown in the figure to the right appears. Check that the correct configuration file is saved, then retry importing.

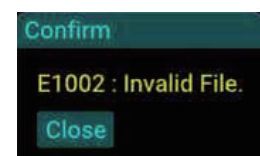

9. Click the [OK] button.

## 3.14 How to Show Software Information

You can show the following software information:

- Application program ID
- Operating system program ID
- Copyright notation
- Open source software information

1. Click the menu button to open the main menu.
2. Click [About].  
Software information is shown on the menu area.

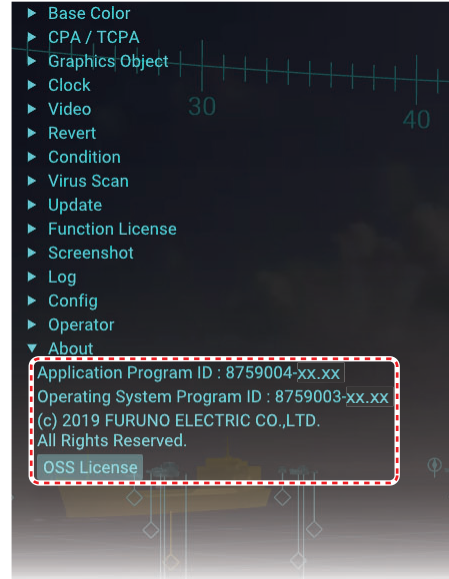

3. Click the [OSS License] button to show the open source software license information.

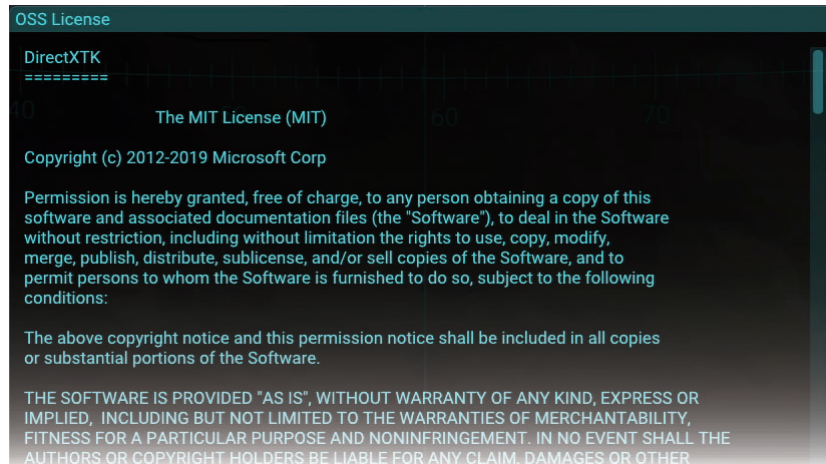

4. Click the [Close] button to close the [OSS License] window.
5. Close the main menu.

# APPX. 1 MENU TREE

Menu button

**Bold italic:** Default setting

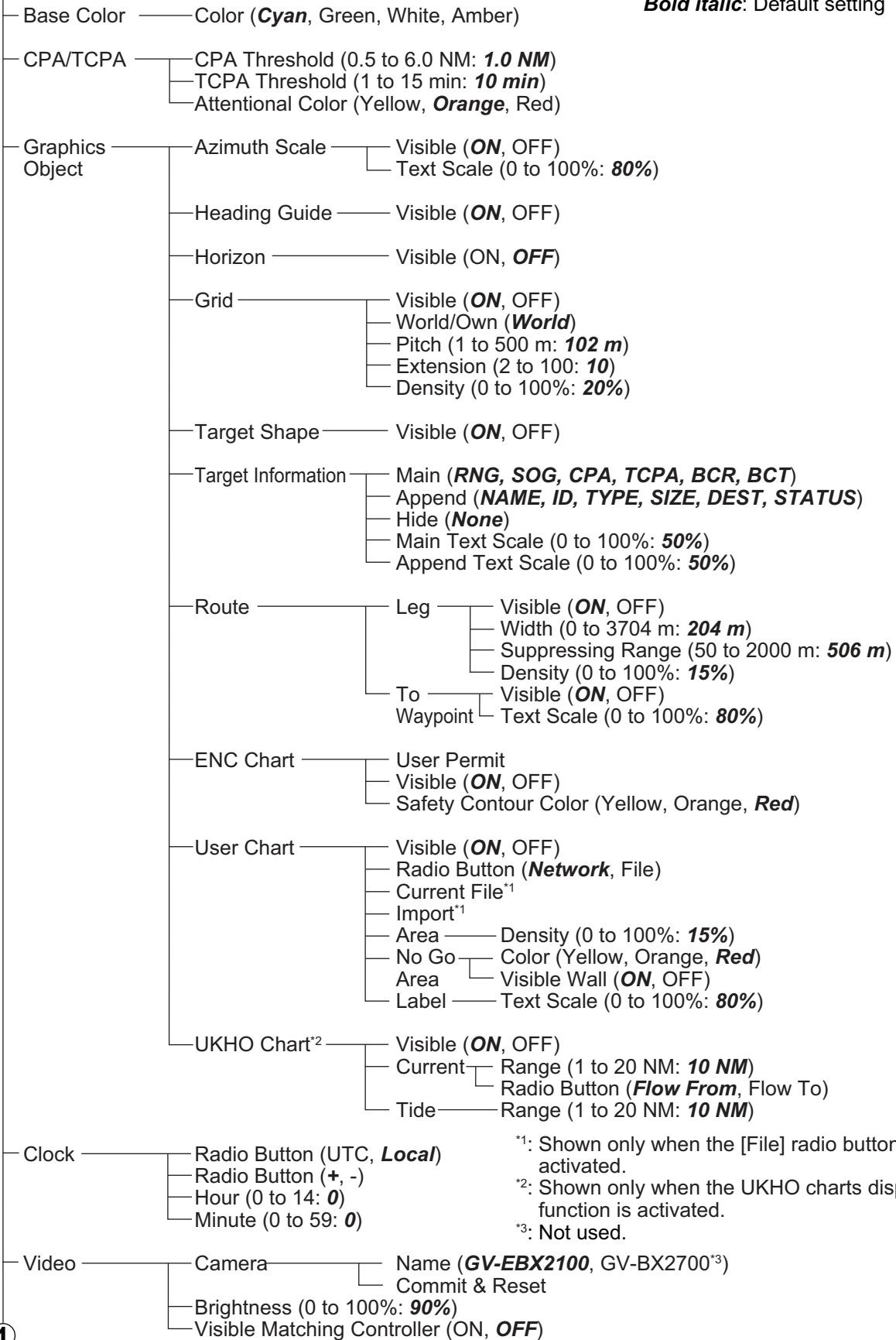

\*1: Shown only when the [File] radio button is activated.

\*2: Shown only when the UKHO charts display function is activated.

\*3: Not used.

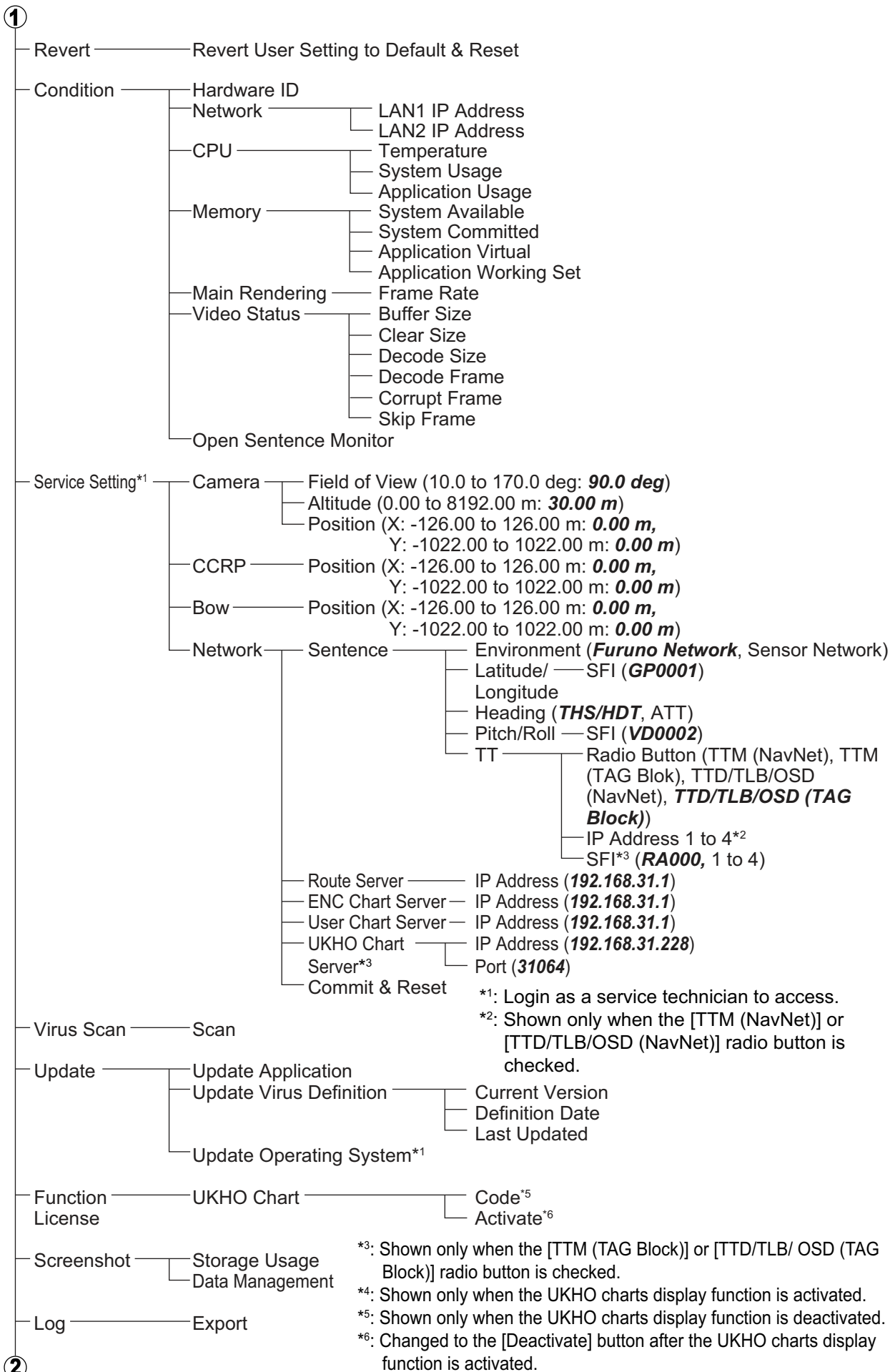



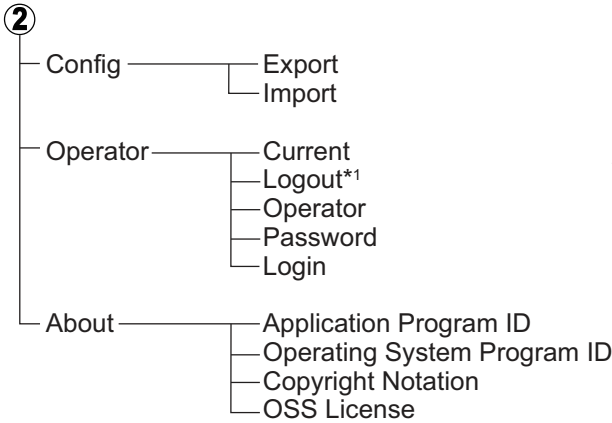

\*1: Login as a service technician to access.

# APPX. 2 ROD TERMINALS

Connector #	Pin #	Signal name	Rod terminal to use	Connected cable
J1	1	24V_VOUT	AI 0.34-6 TQ (blue)	MC1.5-W-Lxxx
	2	24V_GND		
	3	MODBUS-A	AI 0.14-8 GY (gray)	
	4	MODBUS-B		
	5	GND		

Connector #	Pin #	Signal name	Rod terminal to use	Connected cable
J2	1	24V_IN	AI 1.5-6 BK (black)	DPYC-1.5
	2	24V_GND		
	3	PWR_FAIL-A	AI 0.75-6 GY (Gray)	TTYCS-4 TTYCSLA-4
	4	PWR_FAIL-COM		
	5	PWR_FAIL-B		
	6	NC	-	-

Connector #	Pin #	Signal name	Rod terminal to use	Connected cable
J4	1	TD1-A	AI 0.75-6 GY (Gray)	TTYCS-4 TTYCSLA-4
	2	TD1-B		
	3	RD1-A		
	4	RD1-B		
	5	ISOGND1		
	6	RD1-H		
	7	RD1-C		

Connector #	Pin #	Signal name	Rod terminal to use	Connected cable
J5	1	TD2-A	AI 0.75-6 GY (gray)	TTYCS-4 TTYCSLA-4
	2	TD2-B		
	3	RD2-A		
	4	RD2-B		
	5	ISOGND2		
	6	RD2-H		
	7	RD2-C		

Connector #	Pin #	Signal name	Rod terminal to use	Connected cable
J6	1	TD3-A	AI 0.75-6 GY (gray)	TTYCS-4 TTYCSLA-4
	2	TD3-B		
	3	RD3-A		
	4	RD3-B		
	5	ISOGND3		
	6	RD3-H		
	7	RD3-C		

Connector #	Pin #	Signal name	Rod terminal to use	Connected cable
J7	1	TD4-A	AI 0.75-6 GY (gray)	TTYCS-4 TTYCSLA-4
	2	TD4-B		
	3	RD4-A		
	4	RD4-B		
	5	ISOGND4		
	6	RD4-H		
	7	RD4-C		

Connector #	Pin #	Signal name	Rod terminal to use	Connected cable
J8	1	TD5-A	AI 0.75-6 GY (gray)	TTYCS-1Q TTYCSLA-1Q
	2	TD5-B		
	3	RD5-H		
	4	RD5-C		
	5	TD6-A		TTYCS-1Q TTYCSLA-1Q
	6	TD6-B		
	7	RD6-H		
	8	RD6-C		

Connector #	Pin #	Signal name	Rod terminal to use	Connected cable
J9	1	TD7-A	AI 0.75-6 GY (gray)	TTYCS-1Q TTYCSLA-1Q
	2	TD7-B		
	3	RD7-H		
	4	RD7-C		
	5	TD8-A		TTYCS-1Q TTYCSLA-1Q
	6	TD8-B		
	7	RD8-H		
	8	RD8-C		

## **SPECIFICATIONS OF AR NAVIGATION SYSTEM AR-100M**

### **1 MAIN PC**

1.1	CPU	Intel® Celeron® N3350 2.4 GHz
1.2	System memory	4 GB
1.3	Display information	Azimuth, AIS, TT for radar, Route, User chart, ENC chart symbol
1.4	Language	UK/USA

### **2 IP CAMERA**

2.1	Resolution	1920 x 1080 (Full-HD)
2.2	Frame rate	25 fps
2.3	Video compression	H.264
2.4	Source	PoE

### **3 INTERFACE**

3.1	Number of port	
	Video	1 ch, HDMI
	LAN	2 ch, Ethernet, GbE
	USB	USB 2.0: 4 ch, USB3.0: 2 ch
3.2	Data sentences (IEC61162-1/2)	
	Input	GGA, GNS, HDT, OSD, RMB, THS, TLB, TTD, TTM, VDM, VDO, VTG, ZDA
3.3	Sensor adapter (MC-3000S, option)	
	LAN	1 port, Ethernet, 100Base-TX
	Serial	8 ports, I/O, IEC61162-1/2: 4, IEC61162-1: 4
	CANbus (NMEA2000)	1 port

### **4 POWER SUPPLY**

4.1	Main PC	100-240 VAC: 0.9-0.4 A, 1 phase, 50-60 Hz
4.2	PoE adapter	100-240 VAC: 0.2-0.08 A, 1 phase, 50/60 Hz
4.3	Sensor adapter (option)	24 VDC: 1.4 A max.
4.4	AC/DC power supply unit (option)	
	PR-240	100-115/200-230 VAC, 1 phase, 50/60 Hz
	PR-241	100-230 VAC, 1 phase, 50/60 Hz

### **5 ENVIRONMENTAL CONDITIONS**

5.1	Ambient temperature	
	Main PC	-5°C to +60°C
	IP camera	0°C to +50°C
	PoE adapter	-10°C to +50°C
	Sensor adapter	-15°C to +55°C
5.2	Relative humidity	90% or less at +40°C
5.3	Degree of protection	IPX0
5.4	Vibration	Equivalent to standards outlined in IEC 60945 Ed.4 Clause 8.7

## 6 UNIT COLOR

6.1	Main PC	Silver
6.2	IP camera	White
6.3	PoE adapter	Black
6.4	Sensor adapter	N3.0

# PACKING LIST

A-1

AR-100M-N/B

NAME	OUTLINE	DESCRIPTION/CODE No.	QTY
<b>ユニット</b>			
制御箱 (PC)		eBDX100-312-FL-N3350 000-197-271-10	1
FAIRLESS BOX PC			
IPカメラ		GV-EBX2100 000-196-795-10	1
IP CAMERA			
POEアダプタ		GV-PA191 000-197-272-10	1
POE ADAPTER			
トラックボール		K72337JP 000-197-232-10	1
TRACK BALL			
電子キー用トング		ENC-KEY-B 000-037-604-00	1
ENC DONGLE			(*1)
<b>工事材料</b>			
<b>INSTALLATION MATERIALS</b>			
(箱) 工事材料		CP03-40001 001-572-900-00	1
INSTALLATION MATERIALS			
USBケーブル		KU-EN5K 000-197-073-10	2
USB CABLE			
伸縮ブラケット		TB-109 000-197-072-10	1
BRACKET			
<b>図書</b>			
<b>DOCUMENT</b>			
取扱説明書 (英)		OME-45080-* 000-197-341-1*	1
OPERATOR'S MANUAL (EN)			

(\*1)はAR-100M-B用です。(\*1)FOR AR-100M-B.

(略図の寸法は、参考値です。 DIMENSIONS IN DRAWING FOR REFERENCE ONLY.)

A-2

AR-100M-N





NAME	OUTLINE	DESCRIPTION/CODE No.	QTY
<b>ユニット</b>			
電子キー用トング		ENC-KEY-A 000-036-775-00	1
ENC DONGLE			

(略図の寸法は、参考値です。 DIMENSIONS IN DRAWING FOR REFERENCE ONLY.)

CODE NO.	001-572-900-00	0310-X-9401-3
TYPE	CP03-40001	1/1

## 工事材料表

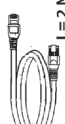
### INSTALLATION MATERIALS

番号 NO.	名称 NAME	略図 OUTLINE	型名/規格 DESCRIPTIONS	数量 Q'TY	用途/備考 REMARKS
1	HDMIケーブル HDMI CABLE	 L=5M	DH-HD14E50/RS CODE NO. 000-197-075-10	1	
2	ケーブル(細品)LAN LAN CABLE ASSEMBLY	 L=10M	F5E-4PTX-BL L=10M CODE NO. 001-592-640-10	2	
3	ケーブル(細品)LAN LAN CABLE ASSEMBLY	 L=2M	F5E-4PTX-BL L=2M CODE NO. 000-164-634-10	1	
4	粘着マット ADHESIVE MAT		TR-GM20-TM CODE NO. 000-199-553-10	1	

(縮図の寸法は、参考値です。 DIMENSIONS IN DRAWING FOR REFERENCE ONLY.)

FURUNO ELECTRIC CO., LTD.

表1 TABLE 1

寸法区分 (mm) DIMENSION	公差 (mm) TOLERANCE
L ≤ 50	±1.5
50 < L ≤ 100	±2.5
100 < L ≤ 500	±3

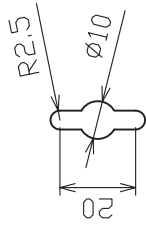

取付穴詳細 (尺度: 1/2)  
DETAIL FOR FIXING (SCALE: 1/2)

電源  
SOURCE

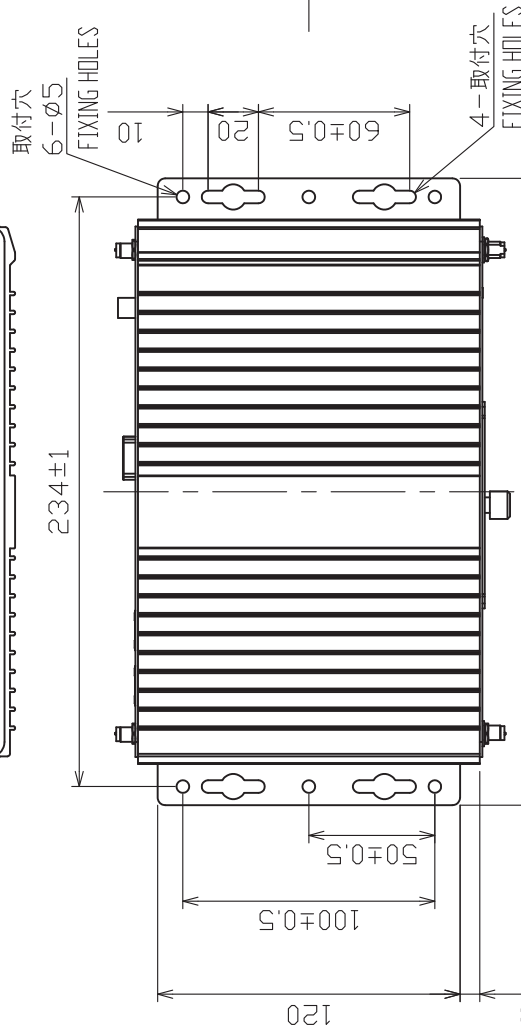
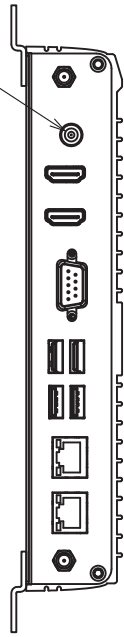

背面  
REAR VIEW

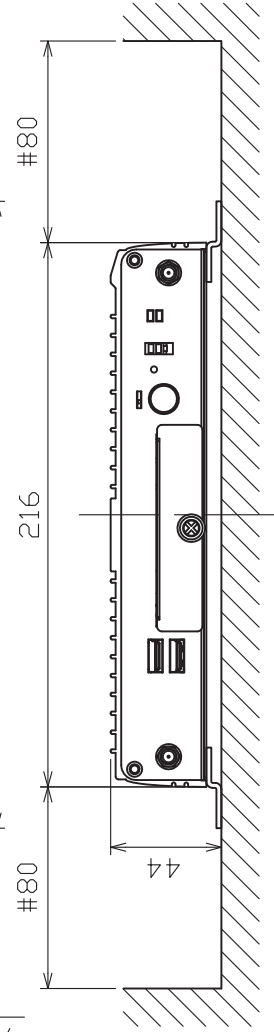
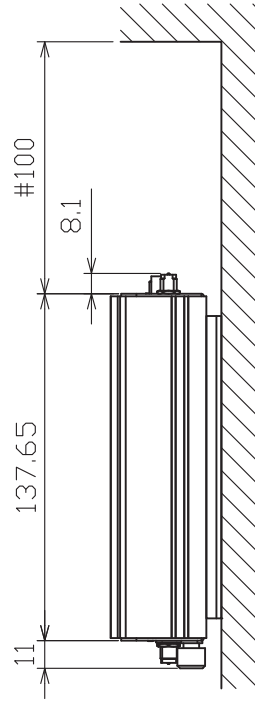
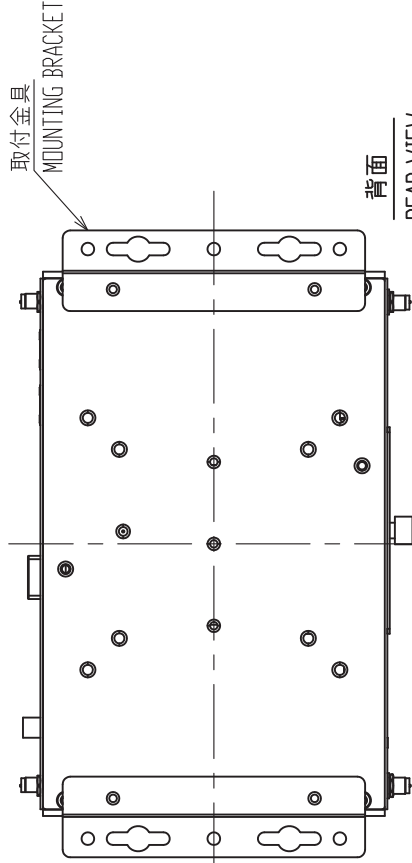

注記

- 1) 指定なき寸法公差は表1による。
- 2) #印寸法は最小サービス空間寸法とする。
- 3) 取付はタップピンネジ呼び径4を使用のこと。

NOTE

1. TABLE 1 INDICATES TOLERANCE OF DIMENSIONS WHICH IS NOT SPECIFIED.
2. # MINIMUM SERVICE CLEARANCE.
3. USE TAPPING SCREWS Ø4 FOR FIXING THE UNIT.

DRAWN	6/Nov/2020	J.YAMASAKI	TITLE	eBOX100-312-FL-N3350
CHECKED	6/Nov/2020	H.MAKI	名称	制御部<卓上・壁掛装備>
APPROVED	13/Nov/2020	H.MAKI	外寸図	
SCALE	1/3	MASS 1.15 kg	質量は取付金具を含む MASS DOES NOT INCLUDE BRACKET.	
DWG.No.	C4508-G02-A	REF.No.		
				MAIN PC (TABLETOP/BULKHEAD MOUNT)
				OUTLINE DRAWING
				eBOX100-312



2

3

4

A

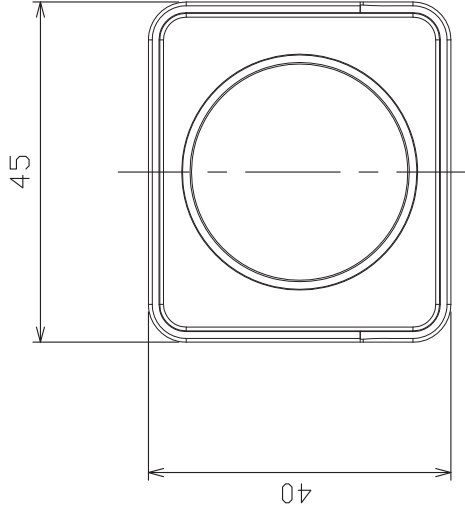

B

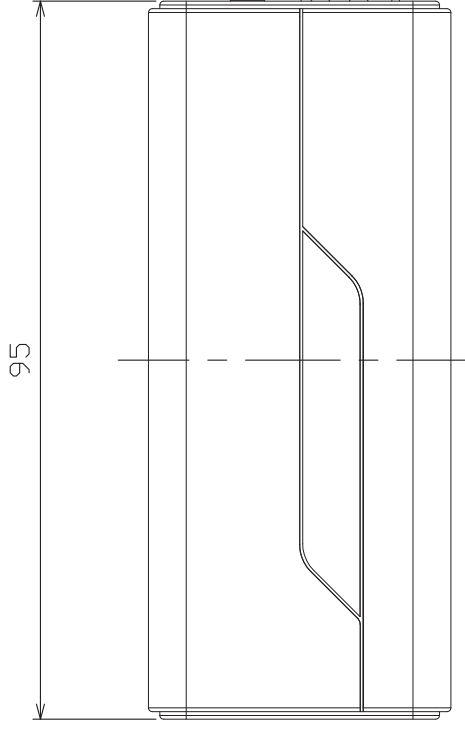

C

DRAWN	12/Nov/2020	T.YAMASAKI
CHECKED	12/Nov/2020	H.MAKI
APPROVED	13/Nov/2020	H.MAKI
SCALE	1/1	MASS ±10% 0.12 kg
DWG.No.	C4508-G03-A	

TITLE	GV-EBX2100
名称	IPカメラ
外寸図	
NAME	IP CAMERA
REF.No.	AR-100M
	OUTLINE DRAWING

4

3

2

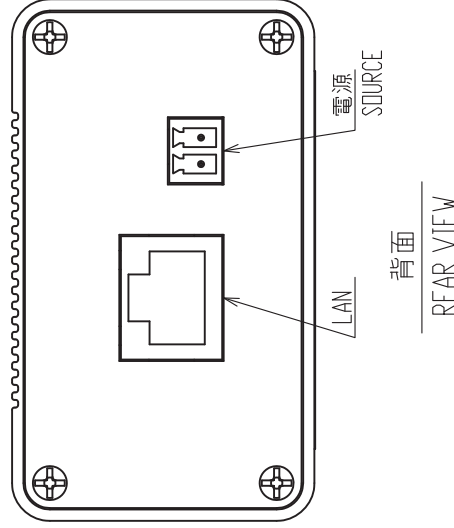
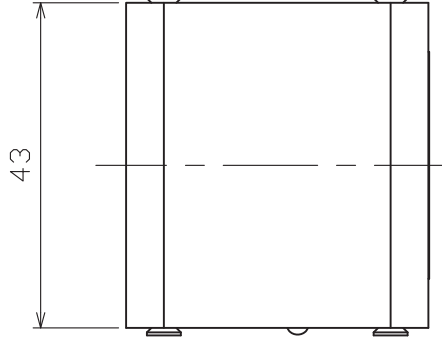
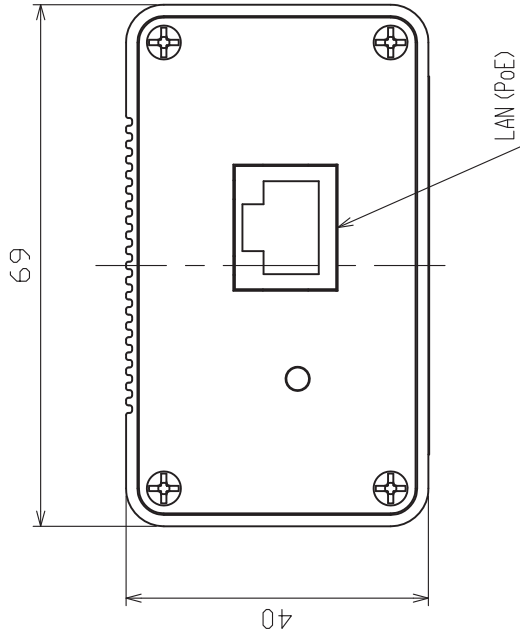

DRAWN	12/Nov/2020	I.YAMASAKI	TITLE	GV-PA191
CHECKED	12/Nov/2020	H.MAKI	名称	POEアダプタ
APPROVED	13/Nov/2020	H.MAKI	外寸図	
SCALE	1/1	MASS ±10% 0.13 kg	NAME	POE ADAPTER
DWG.No.	C4508-G04-A	REF.No.		OUTLINE DRAWING

A

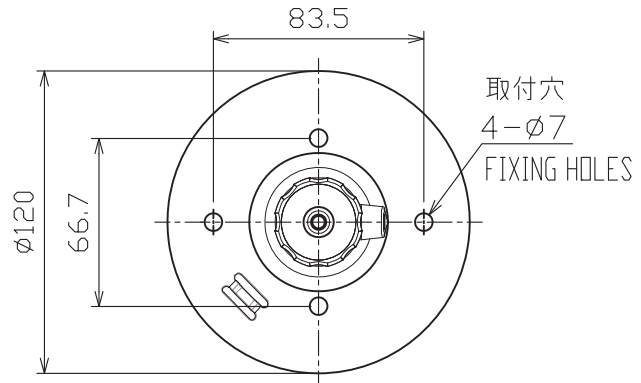

B

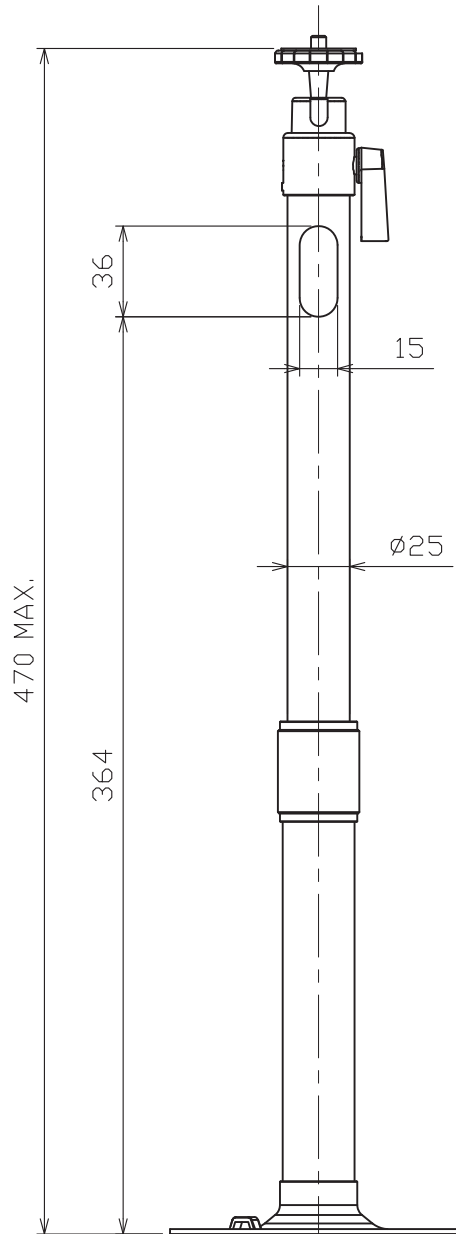

C

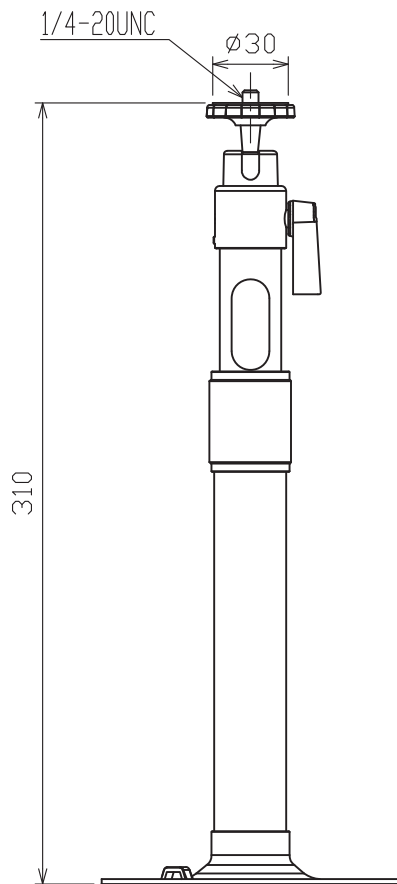

D

DRAWN	12/Nov/2020	T.YAMASAKI		TITLE	TB-109
CHECKED	12/Nov/2020	H.MAKI		名称	伸縮ブラケット
APPROVED	13/Nov/2020	H.MAKI	AR-100M		外寸図
SCALE	1/3	MASS	0.4 ±10% kg	NAME	CAMERA BRACKET
DWG. No.	C4508-G05-A		REF. No.	OUTLINE DRAWING	

A

B

C

D

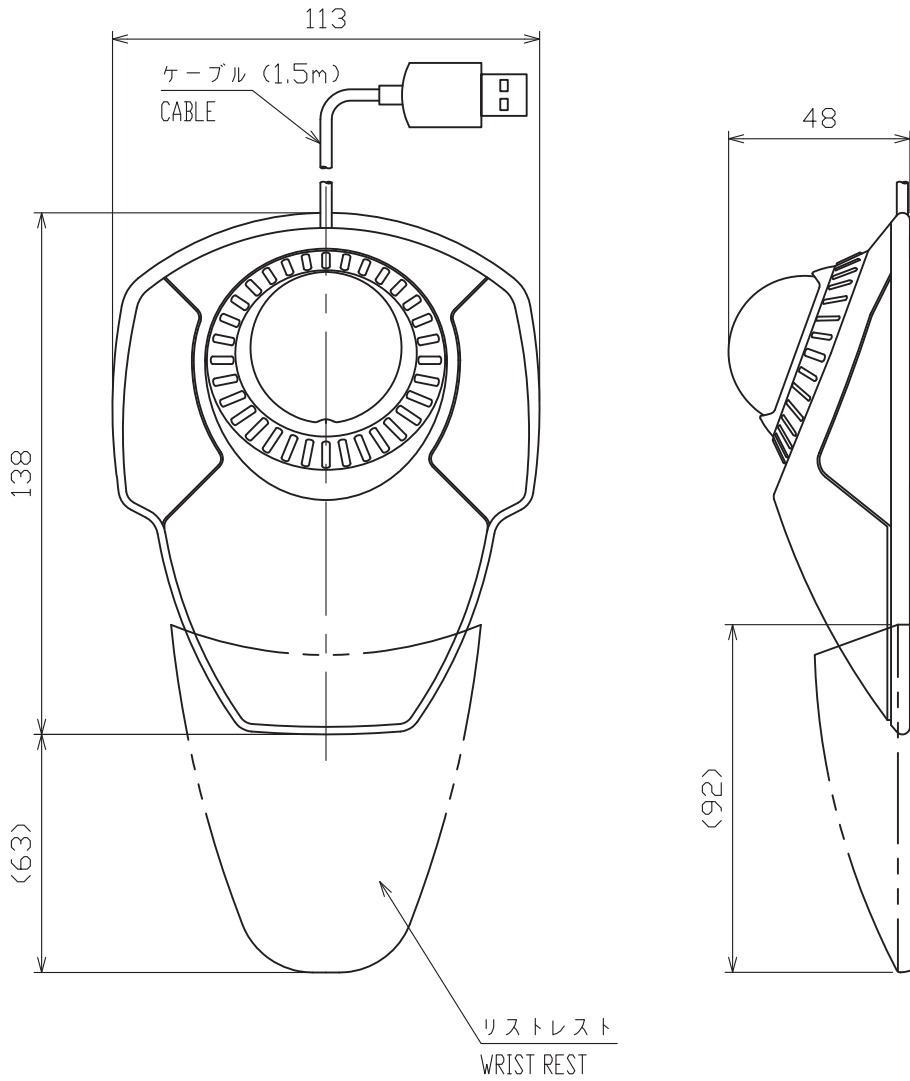

DRAWN	27/Oct/2020 T.YAMASAKI		TITLE	K72337JP
CHECKED	27/Oct/2020 H.MAKI		名称	トラックボール
APPROVED	27/Oct/2020 H.MAKI	AR-100M		外寸図
SCALE	1/2	MASS 0.16 ±10% kg	質量はリストレストを含まず。 MASS DOES NOT INCLUDE WRIST REST.	NAME TRACKBALL
DWG.No.	C4508-G01-A	REF.No.		OUTLINE DRAWING



表1 TABLE 1

寸法区分 (mm) DIMENSION	公差 (mm) TOLERANCE
$L \leq 50$	$\pm 1.5$
$50 < L \leq 100$	$\pm 2.5$
$100 < L \leq 500$	$\pm 3$

- 注記 1) 指定外の寸法公差は表1による。  
 2) #印寸法は最小サービス空間寸法とする。  
 3) 取付用ネジはトラスタップネジ呼び径4×20を使用のこと。

- NOTE 1. TABLE 1 INDICATES TOLERANCE OF DIMENSIONS WHICH IS NOT SPECIFIED.  
 2. #: MINIMUM SERVICE CLEARANCE.  
 3. USE TAPPING SCREWS  $\phi 4 \times 20$  FOR FIXING THE UNIT.

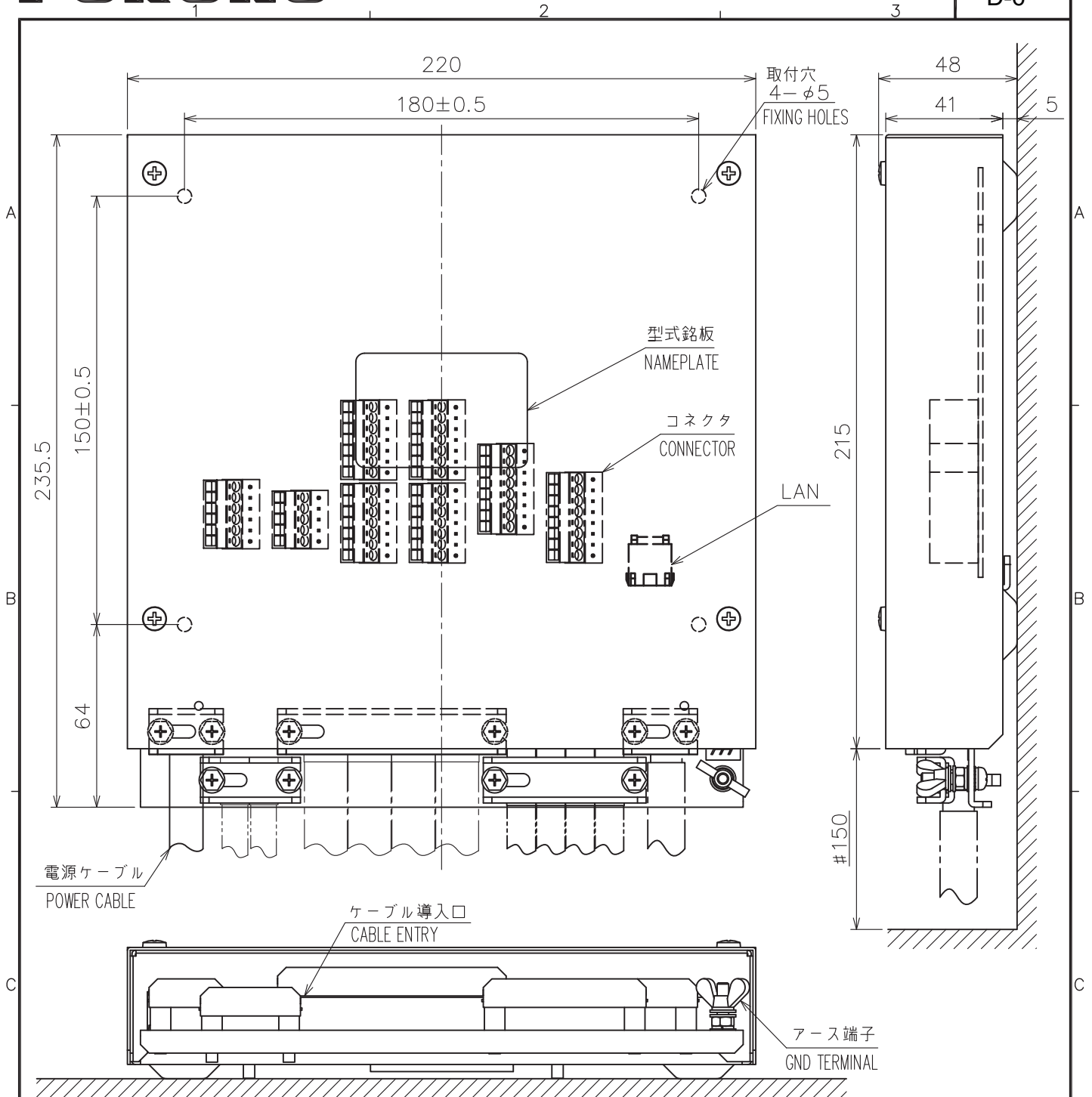
DRAWN	11/Jan/2012 T.YAMASAKI	TITLE	MC-3000S
CHECKED	11/Jan/2012 H.MAKI	名称	センサーアダプター (シリアル)
APPROVED	13/Jan/2012 Y.NISHIYAMA	FMD-3200	外寸図
SCALE	1/2	MASS 1.5 ±10% kg	質量はケーブルを含まず。 MASS DOES NOT INCLUDE CABLE.
DWG. No.	C4473-G08-A	REF. No.	24-014-200G-1
		NAME	SENSOR ADAPTER (SERIAL)
			OUTLINE DRAWING

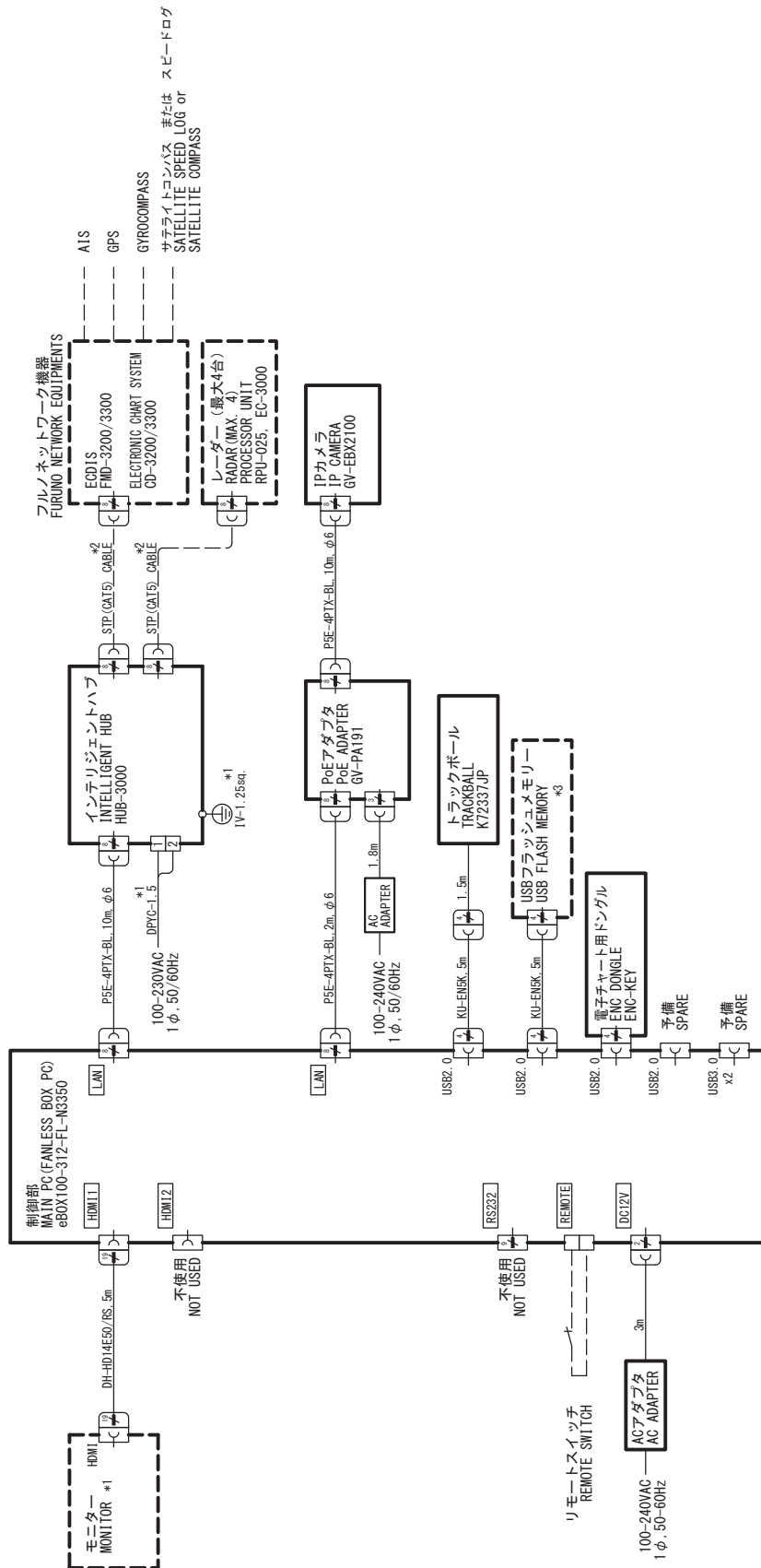

注記  
 \*1) 造船所手配。  
 \*2) オプション。  
 \*3) ユーザー手配。

NOTE  
 \*1: SHIPYARD SUPPLY.  
 \*2: OPTION.  
 \*3: USER SUPPLY.

DRAWN	2/0ct/2020	T. YAMASAKI	TITLE	AR-100M
CHECKED	2/0ct/2020	H. MAKI	名称	AR航海情報表示システム
APPROVED	5/0ct/2020	H. MAKI	相互結線図	
SCALE	1/1000		NAME	AR NAVIGATION SYSTEM
DWG No.	C4508-C01-D		REF. No.	INTERCONNECTION DIAGRAM

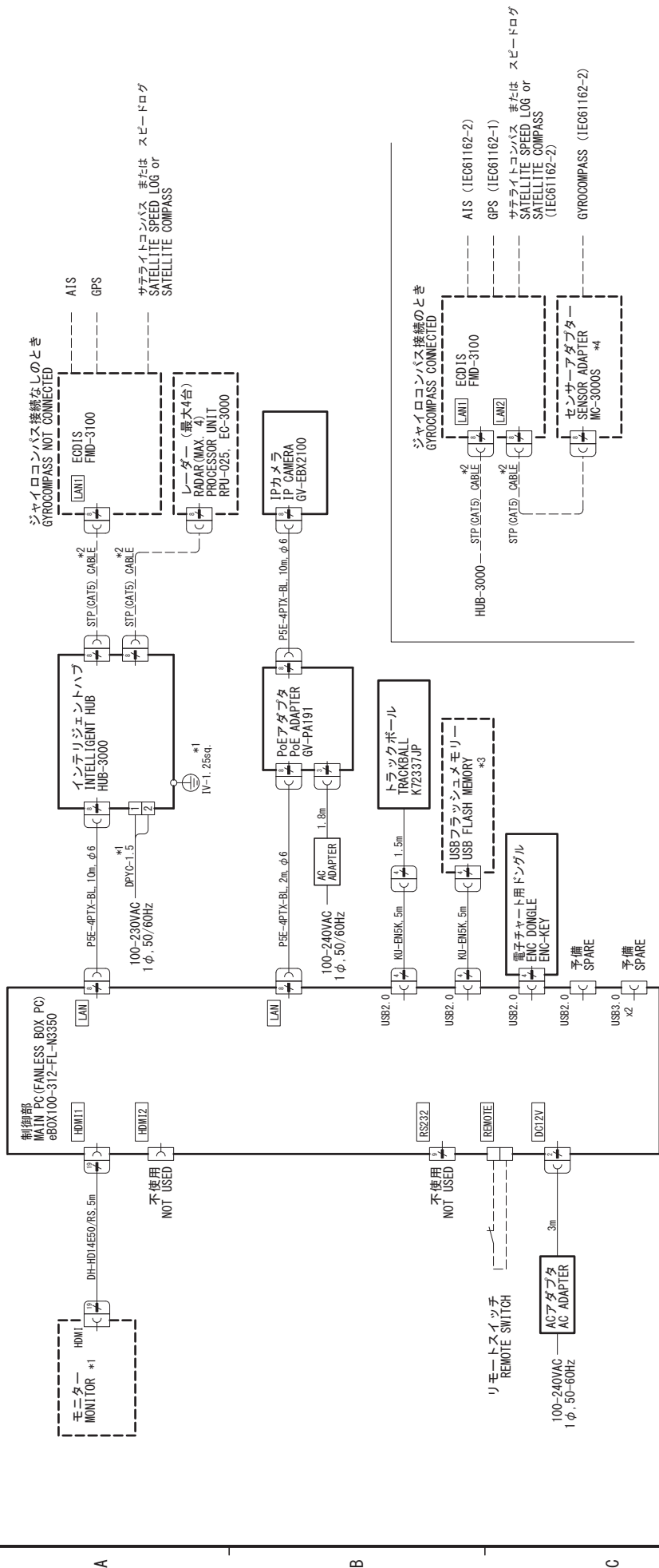

注記

- \*1) 造船所手配。
- \*2) オプション。
- \*3) ユーザー手配。
- \*4) FMD-3100にはIEC61162-2ポートが2つしかないので、AIS/SC/GYROの接続にはMC-3000Sが必要。

NOTE

- \*1: SHIPYARD SUPPLY.
- \*2: OPTION.
- \*3: USER SUPPLY.
- \*4: MC-3000S REQUIRED TO CONNECT AIS/SC/GYRO. SINCE THE FMD-3100 HAS ONLY TWO IEC61162-2 PORTS.

DRAWN	23/Mar/2022	T. YAMASAKI	TITLE	AR-100M
CHECKED	23/Mar/2022	H. IMAKI	名称	AR航海情報表示システム
APPROVED	31/Mar/2022	H. IMAKI	相互接続図	
SCALE	1/MASS		NAME	AR NAVIGATION SYSTEM
DWG No.	C4508-C03-A		REF. No.	INTERCONNECTION DIAGRAM

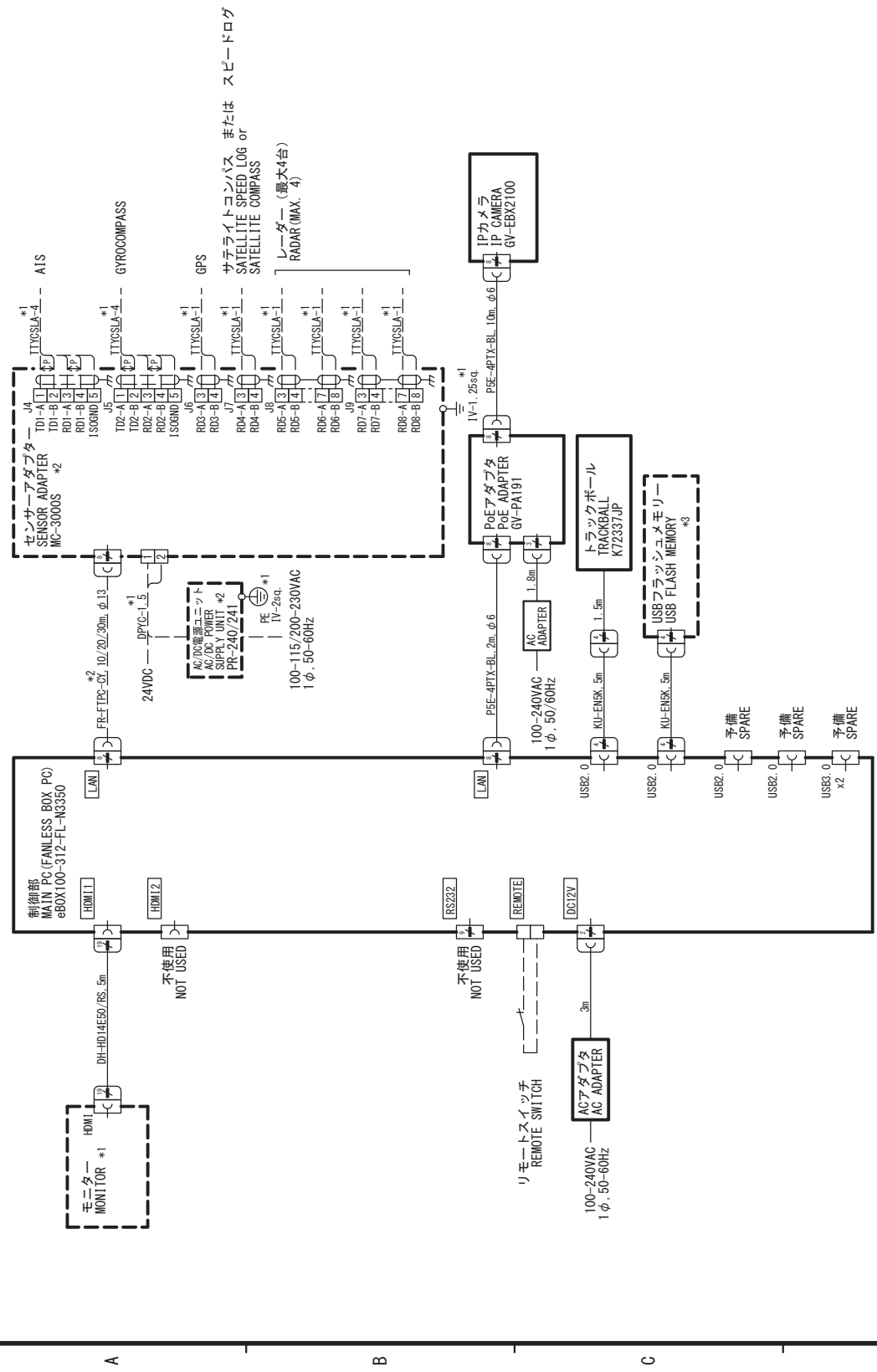

注記  
 \*1) 造船所手配。  
 \*2) オプション。  
 \*3) ユーザー手配。

NOTE  
 \*1: SHIPYARD SUPPLY.  
 \*2: OPTION.  
 \*3: USER SUPPLY.

DRAWN	5/0ct/2020	T. YAMASAKI	TITLE	AR-100M (MC-3000S)
CHECKED	5/0ct/2020	H. IMAKI	名称	AR航海情報表示システム
APPROVED	5/0ct/2020	H. IMAKI	相互結線図	
SCALE		IMASS	NAME	AR NAVIGATION SYSTEM
DWG No.	04508-C02-B	kg	REF. No.	INTERCONNECTION DIAGRAM



# INDEX

---

## A

- AIS symbol ..... 1-4
- Appended target information frame .... 1-5, 1-10
- Application program ID ..... 3-20
- Attentional color ..... 1-7
- Azimuth scale ..... 1-4, 1-7

## B

- Base color ..... 1-6

## C

- Configuration file
  - import ..... 3-18
- Configutaion file
  - export ..... 3-17
- Copyright notation ..... 3-20
- CPA threshold ..... 1-7
- CPA/TCPA ..... 1-7

## D

- Date ..... 1-4
- Display overview ..... 1-3

## E

- ENC chart objects ..... 1-13
  - Buoy ..... 1-13
  - Coast line ..... 1-13
  - Pilot station ..... 1-13
  - Safety contour ..... 1-13
- ENC dongle ..... 1-1, 2-6
- Error button ..... 1-4
- Error code ..... 3-3
- Error frame ..... 1-4
- Error message ..... 3-3

## G

- Grid ..... 1-5, 1-9
  - Density ..... 1-9
  - Extension ..... 1-9
  - Own ..... 1-9
  - Pitch ..... 1-9
  - World ..... 1-9

## H

- Heading guide ..... 1-4, 1-8
- Horizon line ..... 1-4, 1-8
- H-UP (Head up) ..... 1-4, 1-6

## I

- Initial settings
  - Bow position ..... 2-19
  - CCRP ..... 2-18
  - Data source for pitch/roll data ..... 2-21
  - Data source for position data ..... 2-20
  - Data source for TT data ..... 2-21
  - IP address of ENC chart server ..... 2-23
  - IP address of route server ..... 2-23
  - IP address of UKHO chart server ..... 2-24

- IP address of user chart server ..... 2-24
- IP camera settings ..... 2-18
- MC-3000S settings ..... 2-26
- Nework selection ..... 2-20
- Service mode login ..... 2-17
- Settings for connected equipment ..... 2-25

## Interface

- IP camera ..... 2-8
- Main PC ..... 2-5
- PoE adapter ..... 2-7

## L

- Log
  - Copying ..... 3-16

## M

- Main menu ..... 1-4
- Main target information frame ..... 1-5, 1-10
- Menu button ..... 1-3
- Menu tree ..... AP-1
- Mounting
  - Camera bracket ..... 2-2
  - Main PC ..... 2-1
  - PoE adapter ..... 2-2
  - Trackball ..... 2-3

## N

- No-go area ..... 1-4, 1-17
- N-UP (North up) ..... 1-4, 1-6

## O

- Open source software information ..... 3-20
- Operating system program ID ..... 3-20
- Operation check ..... 2-34
- Overview ..... 1-1

## P

- Power button ..... 1-2
- Presentation mode ..... 1-4, 1-6

## R

- Range ..... 1-4
- Range control ..... 1-6
- Range control button ..... 1-4
- Recommended replacement period ..... 3-1
- Remote PWR switch ..... 2-6
- Restore default settings ..... 3-9
- Route ..... 1-5, 1-12
  - Density ..... 1-12
  - Suppressing range ..... 1-12
  - Width ..... 1-12

## S

- Screenshot
  - Copying ..... 1-27
  - Deleting ..... 1-29
  - Taking ..... 1-27
- Screenshot button ..... 1-3

## INDEX

Selective marker .....	1-4
Sentence monitor .....	3-11
Software information .....	3-20
Startup process .....	1-3
Symbols in the TVI .....	1-6
System information .....	3-10

### **T**

Target information	
Appended target information frame .....	1-10
Available data .....	1-11
Customize .....	1-10
Main target information frame .....	1-10
Target shape .....	1-5, 1-10
TCPA threshold .....	1-7
Trackball .....	1-2
Troubleshooting .....	3-2
TT symbol .....	1-4
TVI .....	1-4, 1-5
TVI presentation mode button .....	1-4

### **U**

UKHO charts	
activating function .....	1-20
activation code .....	1-20
current information .....	1-19
current information setup .....	1-21
deactivating function .....	1-22
tide information .....	1-19
tide information setup .....	1-21
Updating operating system .....	3-15
Updating virus definition .....	3-13
User chart label .....	1-4
User charts .....	1-14
Density for area object .....	1-17
Import .....	1-15
sharing via LAN .....	1-14
Text size for label object .....	1-18

### **V**

Video image brilliance .....	1-24
Video image position .....	1-24
Virus scan .....	3-11
Visible wall .....	1-4, 1-17

### **W**

Waypoint information .....	1-4, 1-13
Working indicator .....	1-4



## Declaration of Conformity



We **FURUNO ELECTRIC CO., LTD.**

(Manufacturer)

9-52 Ashihara-Cho, Nishinomiya City, 662-8580, Hyogo, Japan

(Address)

declare under our sole responsibility that the product

**AR NAVIGATION SYSTEM AR-100M**

(Model name, type number)

to which this declaration relates conforms to the following standard(s) or other normative document(s)

### EU

EMC Directive 2014/30/EU

IEC 60945 Ed.4.0: 2002  
EN 61000-3-2: 2014  
EN 61000-3-3: 2013  
EN 55024: 2010/ A1: 2015  
EN 55032: 2015/ AC: 2016/A11: 2020, Class A  
CISPR 32 Ed.2.0: 2015/ C1: 2016  
EN 55035: 2017/A11: 2020

For assessment, see

• Test report  
Labotech International Co., Ltd.  
LIC 12-19-174, 24 Sep 2019  
LIC 12-21-162, 17 Dec 2021

Wendell EMC & RF Laboratory  
WD-EE-R-210290-A0, 8 Oct 2021

Compliance Certification Services Inc.  
T170704D07-E, 7 Jul 2017

SPORTON International Inc.  
EC420670, 10 Mar 2014

### UK

SI 2016 No.1091 EMC Regulations 2016 as amended

EN 60945: 2002  
EN 61000-3-2: 2014  
EN 61000-3-3: 2013  
EN 55024: 2010/ A1: 2015  
EN 55032: 2015/ AC: 2016/A11: 2020, Class A  
CISPR 32 Ed.2.0: 2015/ C1: 2016  
EN 55035: 2017/A11: 2020

For assessment, see

• Test report  
Labotech International Co., Ltd.  
LIC 12-19-174, 24 Sep 2019  
LIC 12-21-162, 17 Dec 2021

Wendell EMC & RF Laboratory  
WD-EE-R-210290-A0, 8 Oct 2021

Compliance Certification Services Inc.  
T170704D07-E, 7 Jul 2017

SPORTON International Inc.  
EC420670, 10 Mar 2014

Publication No. DOCQA1540

On behalf of Furuno Electric Co., Ltd.

Nishinomiya City, Japan  
22 December 2021

-----  
(Place and date of issue)

Akihiko Kanechika  
Department General Manager  
Quality Assurance Department

*A. Kanechika*  
-----  
(name and signature or equivalent marking of authorized person)