

# **FURUNO**

## **OPERATOR'S MANUAL**

*ALARM UNIT*

Model **IC-350**

---



# IMPORTANT NOTICES

---

## General

- This manual has been authored with simplified grammar, to meet the needs of international users.
- The operator of this equipment must read and follow the descriptions in this manual. Wrong operation or maintenance can cancel the warranty or cause injury.
- Do not copy any part of this manual without written permission from FURUNO.
- If this manual is lost or worn, contact your dealer about replacement.
- The contents of this manual and equipment specifications can change without notice.
- The example screens (or illustrations) shown in this manual can be different from the screens you see on your display. The screens you see depend on your system configuration and equipment settings.
- Save this manual for future reference.
- Any modification of the equipment (including software) by persons not authorized by FURUNO will cancel the warranty.
- The following concern acts as our importer in Europe, as defined in DECISION No 768/2008/EC.
  - Name: FURUNO EUROPE B.V.
  - Address: Siriusstraat 86, 5015 BT, Tilburg, The Netherlands
- The following concern acts as our importer in UK, as defined in SI 2016/1025 as amended SI 2019/470.
  - Name: FURUNO (UK) LTD.
  - Address: West Building Penner Road Havant Hampshire PO9 1QY, U.K.
- All brand and product names are trademarks, registered trademarks or service marks of their respective holders.

## How to discard this product

Discard this product according to local regulations for the disposal of industrial waste. For disposal in the USA, see the homepage of the Electronics Industries Alliance (<http://www.eiae.org/>) for the correct method of disposal.

## How to discard a used battery

Some FURUNO products have a battery(ies). To see if your product has a battery, see the chapter on Maintenance. Follow the instructions below if a battery is used. Tape the + and - terminals of battery before disposal to prevent fire, heat generation caused by short circuit.

### In the European Union

The crossed-out trash can symbol indicates that all types of batteries must not be discarded in standard trash, or at a trash site. Take the used batteries to a battery collection site according to your national legislation and the Batteries Directive 2006/66/EU.

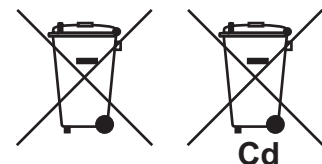

### In the USA

The Mobius loop symbol (three chasing arrows) indicates that Ni-Cd and lead-acid rechargeable batteries must be recycled. Take the used batteries to a battery collection site according to local laws.

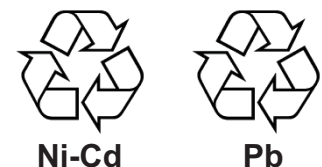



### In the other countries

There are no international standards for the battery recycle symbol. The number of symbols can increase when the other countries make their own recycle symbols in the future.











# SAFETY INSTRUCTIONS

The installer and operator of this equipment must read these safety instructions before attempting to install or operate the equipment.

 <b>WARNING</b>	Indicates a potentially hazardous situation which, if not avoided, could result in death or serious injury.
 <b>CAUTION</b>	Indicates a potentially hazardous situation which, if not avoided, may result in minor or moderate injury.





 Warning, Caution	 Prohibitive Action	 Mandatory Action
--	--	--



 <b>WARNING</b>	
	<b>If something is dropped into the equipment or water leaks into the equipment, turn off the power at the switchboard immediately.</b>  Continued use of the equipment can cause fire or electrical shock.
	<b>If the equipment is emitting smoke or fire, shut off the power at the switchboard immediately.</b>  Continued use of the equipment can cause fire or electrical shock. Consult a FURUNO agent or dealer for advice.
	<b>If the equipment is acting abnormally, shut off the power at the switchboard immediately.</b>  Continued use of the equipment can cause fire or electrical shock. Consult a FURUNO agent or dealer for advice.

 <b>WARNING</b>	
	<b>Do not operate a DISTRESS button unless YOUR vessel is in distress.</b>  The distress signal is sent when a DISTRESS button is operated. If the distress signal is accidentally sent, contact a coast station immediately to report accidental distress transmission.
	<b>Do not place liquid-filled containers on the top of the equipment.</b>  Fire or electrical shock can result.
	<b>Do not operate the equipment with wet hands.</b>  Electrical shock can result.
	<b>Do not disassemble or modify the equipment.</b>  Electrical shock, fire or bodily injury can result.

 <b>CAUTION</b>
<b>If distress is accidentally sent, immediately contact a coast station and provide the following information:</b> <ul style="list-style-type: none"> <li>- Ship's name</li> <li>- Ship's call sign and DSC number</li> <li>- Position at time of distress transmission</li> <li>- Time of distress transmission</li> </ul>

Precautions for the installer

 <b>WARNING</b>	
	<p><b>Shut off the power at the switchboard before beginning the installation.</b></p> <p>Fire or electrical shock can result if the equipment is powered while it is being installed.</p>
	<p><b>Use only the specified power cable.</b></p> <p>Fire or electrical shock can result if a different cable is used.</p>
	<p><b>Do not install the equipment where it can get wet from rain or water splash.</b></p> <p>Fire or electrical shock can result if water gets inside the equipment.</p>

 <b>CAUTION</b>	
	<p><b>Be sure the voltage at the ship's switchboard is compatible with the voltage rating of this equipment.</b></p> <p>The rated voltage of this equipment is 24 VDC. Damage to the equipment can result if the equipment is connected to an incompatible power supply.</p>
	<p><b>Observe the compass safe distances shown below to prevent interference to a magnetic compass.</b></p> <p>Standard compass: 1.20 m Steering compass: 0.75 m</p>

# TABLE OF CONTENTS

---

<b>FOREWORD .....</b>	<b>v</b>
<b>SYSTEM CONFIGURATION .....</b>	<b>vi</b>
<b>1. INSTALLATION .....</b>	<b>1</b>
1.1 Equipment Lists.....	1
1.2 How to Install the Alarm Unit.....	1
1.3 Connections .....	2
1.3.1 Where to connect the cables .....	2
1.3.2 Cable fabrications .....	3
1.4 Settings .....	6
<b>2. OPERATION .....</b>	<b>9</b>
2.1 Controls and Indicators .....	9
2.2 How to Set the Unit to Stand-by.....	9
2.3 When You Receive a Distress Signal .....	10
2.4 How to Send a Distress Signal.....	10
2.5 How to Operate the Dual Alarm Unit.....	11
<b>3. MAINTENANCE .....</b>	<b>12</b>
3.1 Maintenance.....	12
3.2 How to Clean the Equipment .....	12
3.3 Circuit Breaker .....	13
3.4 Troubleshooting .....	13
3.5 Equipment Test .....	13
<b>SPECIFICATIONS .....</b>	<b>SP-1</b>
<b>OUTLINE DRAWING .....</b>	<b>D-1</b>
<b>INTERCONNECTION DIAGRAM .....</b>	<b>S-1</b>

# FOREWORD

---

Congratulations on your choice of the FURUNO IC-350 Alarm Unit. We are confident you will see why the FURUNO name has become synonymous with quality and reliability.

Since 1948, FURUNO Electric Company has enjoyed an enviable reputation for quality marine electronics equipment. This dedication to excellence is furthered by our extensive global network of agents and dealers.

This equipment is designed and constructed to meet the rigorous demands of the marine environment. However, no machine can perform its intended function unless installed, operated and maintained properly. Please carefully read and follow the recommended procedures for installation, operation and maintenance.

## Features

The IC-350 globally controls the distress functions of all GMDSS equipment connected to it. The main features are

- Connects to six GMDSS units: one SSB radiotelephone, two VHF radiotelephones, two Inmarsat-C mobile earth stations (MES), and one NAVTEX receiver.
- Dedicated DISTRESS buttons for sending a distress alert.
- MUTE ALARM button stops audio alarm.
- Second alarm unit (option) allows control from a remote location.

## **CE/UKCA declaration**

With regards to CE/UKCA declarations, please refer to our website ([www.furuno.com](http://www.furuno.com)) for further information about RoHS conformity declarations.

## **Disclosure of Information about China RoHS**

With regards to China RoHS information for our products, please refer to our website ([www.furuno.com](http://www.furuno.com)).

# SYSTEM CONFIGURATION

Standard configuration shown with solid lines.

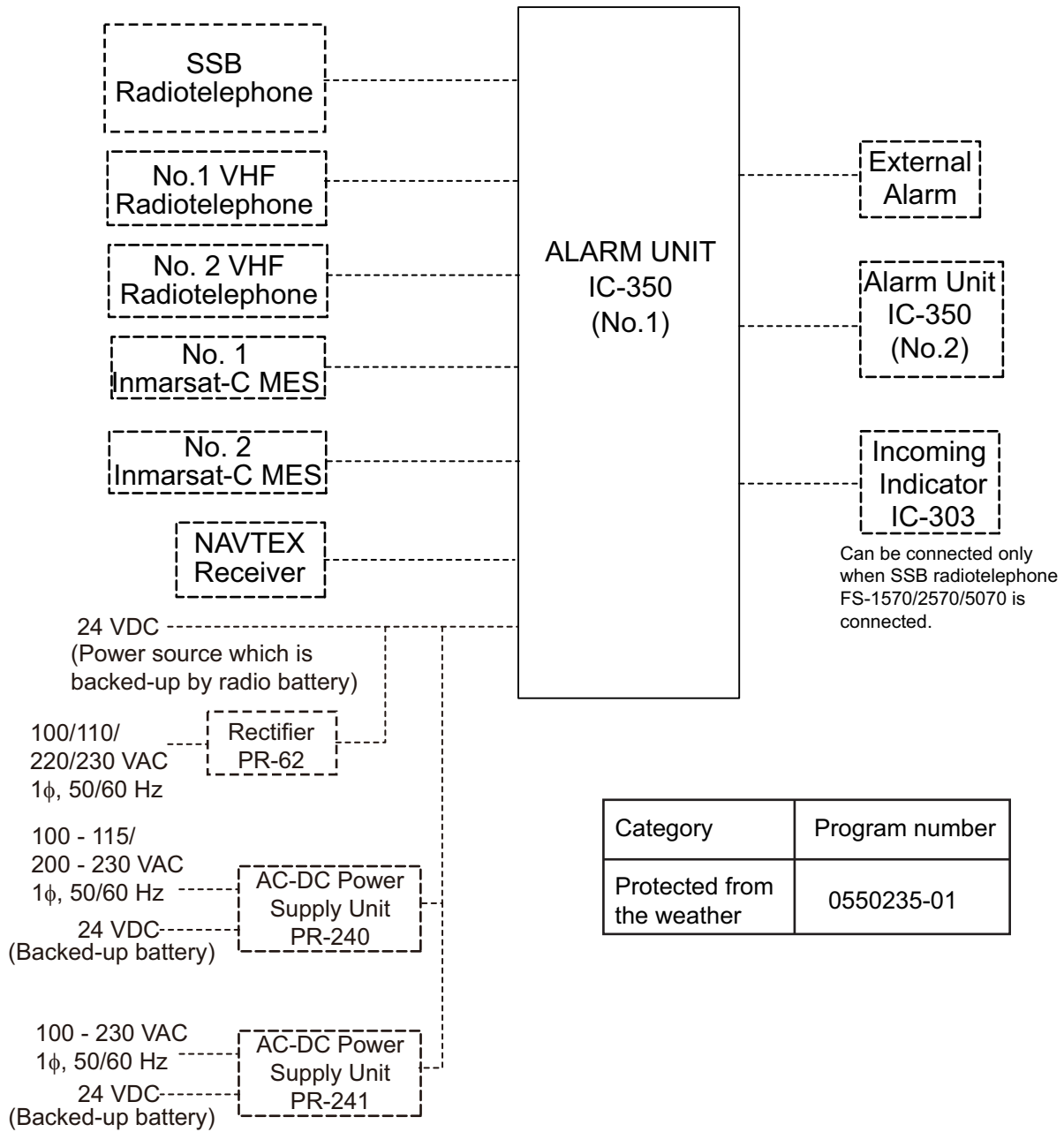

Category	Program number
Protected from the weather	0550235-01



# 1. INSTALLATION

## 1.1 Equipment Lists

### Standard supply

Name	Type	Code No.	Qty	Remarks
Alarm Unit	IC-350	—	1	
Installation Materials	CP05-11701	000-041-190	1 set	Self-tapping screws ( $\phi 4 \times 20$ , 4pcs) (000-158-850-10)
Accessory	FP05-06401	001-058-090	1	SPARE sticker

### Optional supply

Name	Type	Qty	Remarks
Rectifier	PR-62	1	AC input, 24 VDC output
AC-DC Power Supply	PR-240	1	AC, DC input, 24 VDC output
	PR-241	1	
Ferrite Core	OP86-11	1	For PR-241 (001-594-450)
Alarm Unit	IC-350	1	For dual connection

## 1.2 How to Install the Alarm Unit

See the outline drawing at the back of this manual for dimensions. Install the alarm unit in a console. Make a cutout in the location for the unit, the dimensions of which are 277(W) $\times$ 287(H). Set the unit to the cutout. Fasten the unit with four self-tapping screws (supplied).

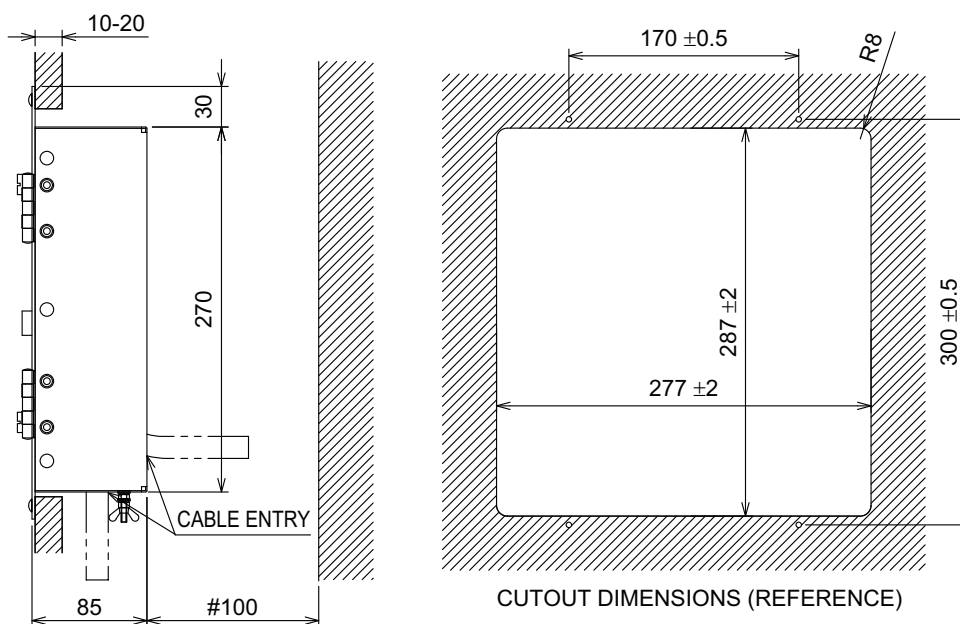

1. INSTALLATION

# 1.3 Connections

## 1.3.1 Where to connect the cables

The cable connections for external equipments are as shown in the following figure. Refer to the interconnection diagram at the back of this manual for details.

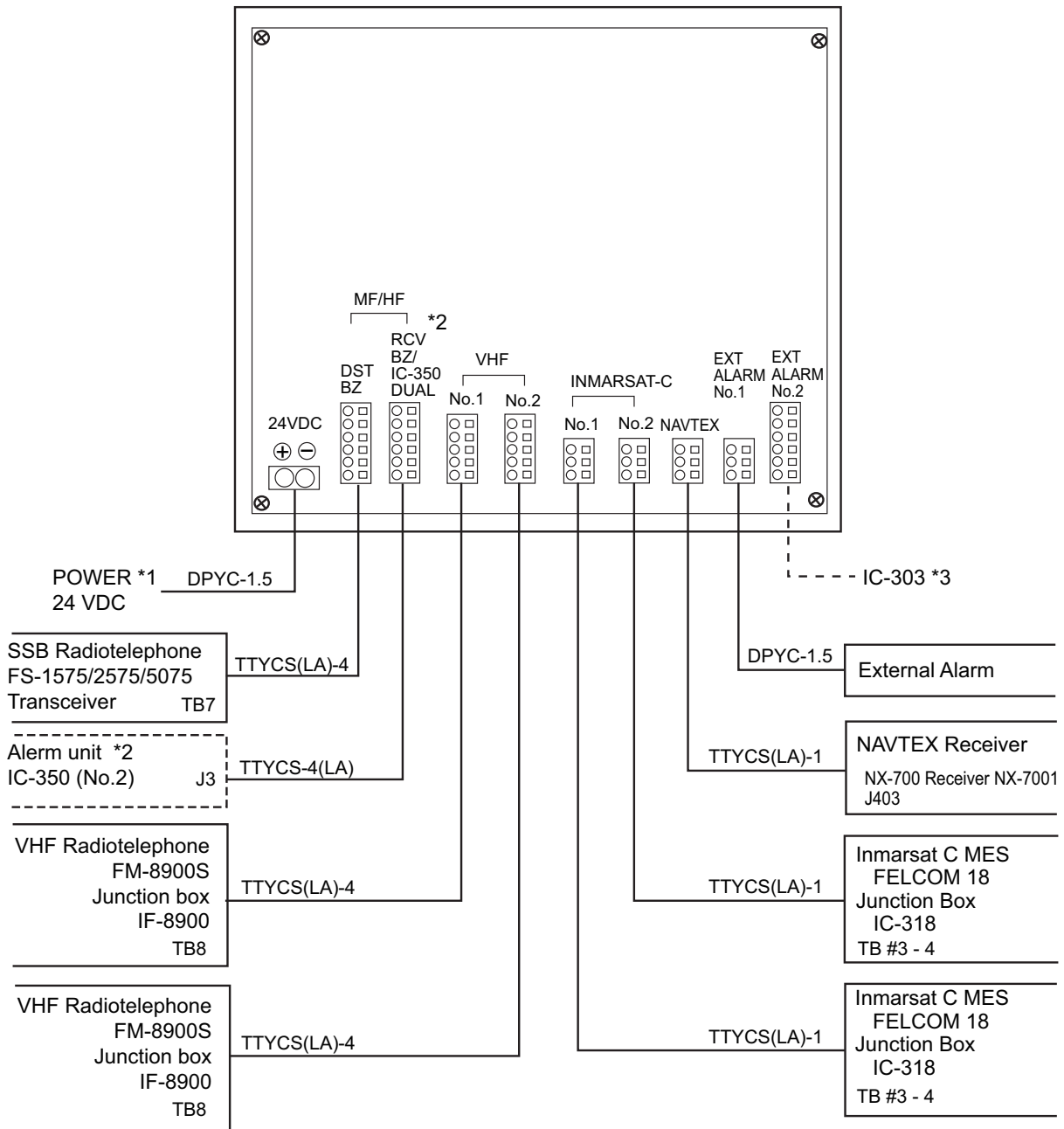

\*1: Power must be supplied from a power source which is backed-up by radio battery.

\*2: IC-350 dual installation requires setting modification.

\*3: The IC-303 can be connected only when the SSB radiotelephone FS-1570/2570/5070 is connected.

The dashed line indicates optional equipment.

### 1.3.2 Cable fabrications

This section shows the cable fabrications. The text between parentheses in the section titles are the names of Japan Industry Standard (JIS) cables. Use those cables or their equivalents.

#### Power cable (DPYC-1.5)

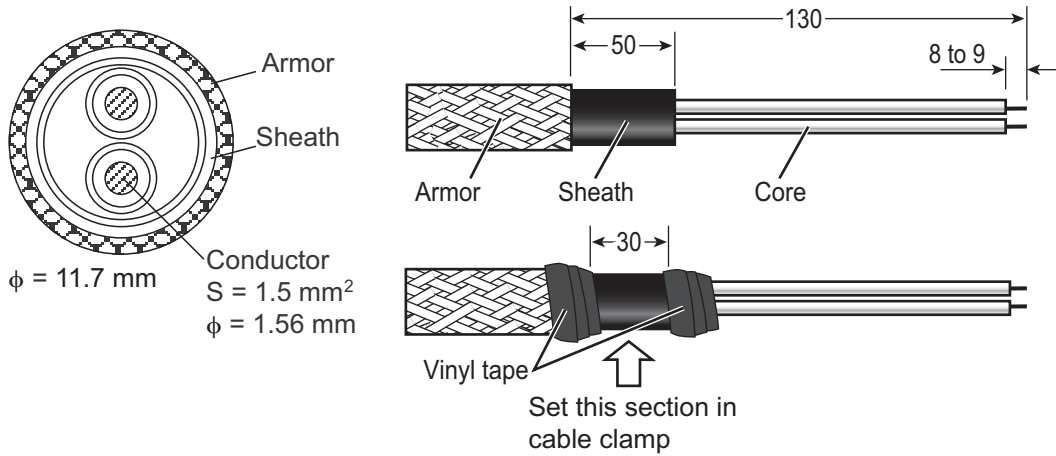

#### Signal cable (TTYCS(LA)-1/4)

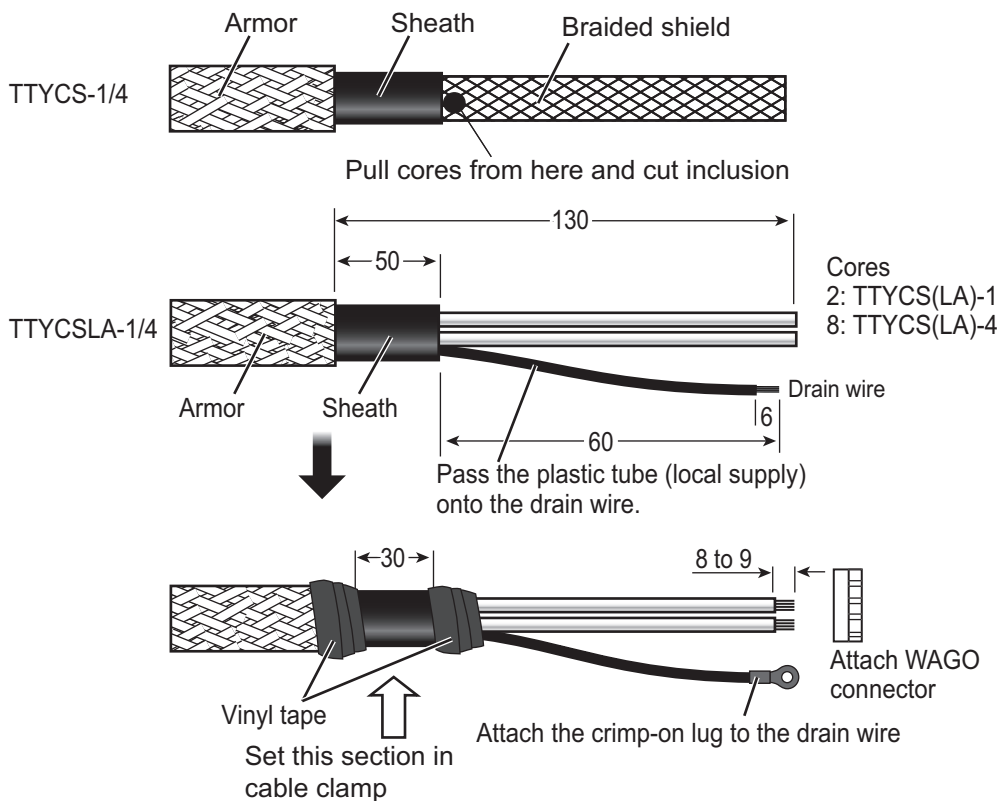

## 1. INSTALLATION

### Cable for external alarm (DPYC-1.5)

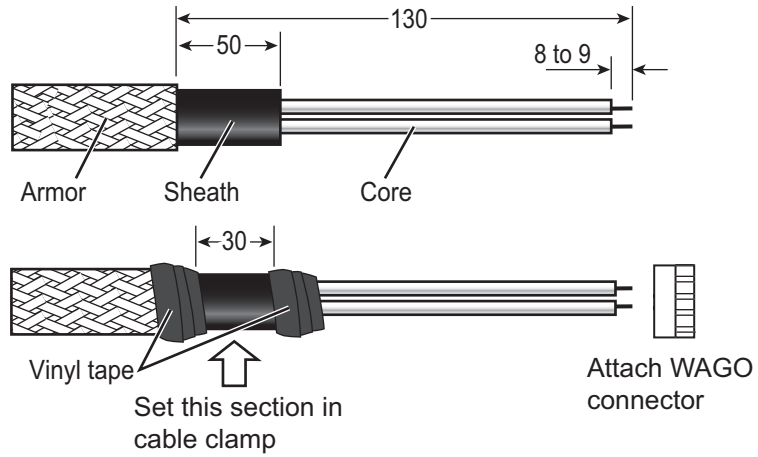

### How to fasten a WAGO connector

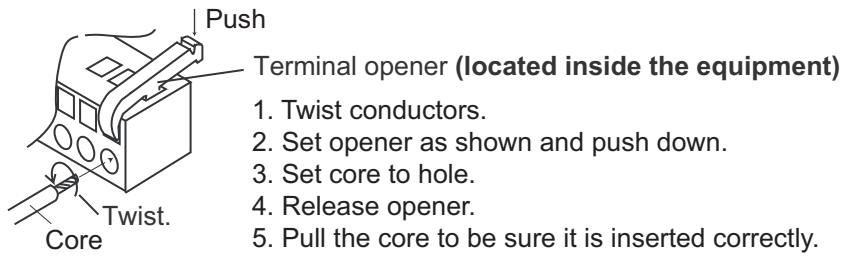

**How to connect the cables**

The lid at the bottom of the chassis seals the bottom cable entrance. To lead in cables through the bottom of the chassis (rather than the rear), unfasten two screws to remove the lid and use the lid to cover the rear panel cable entrance.

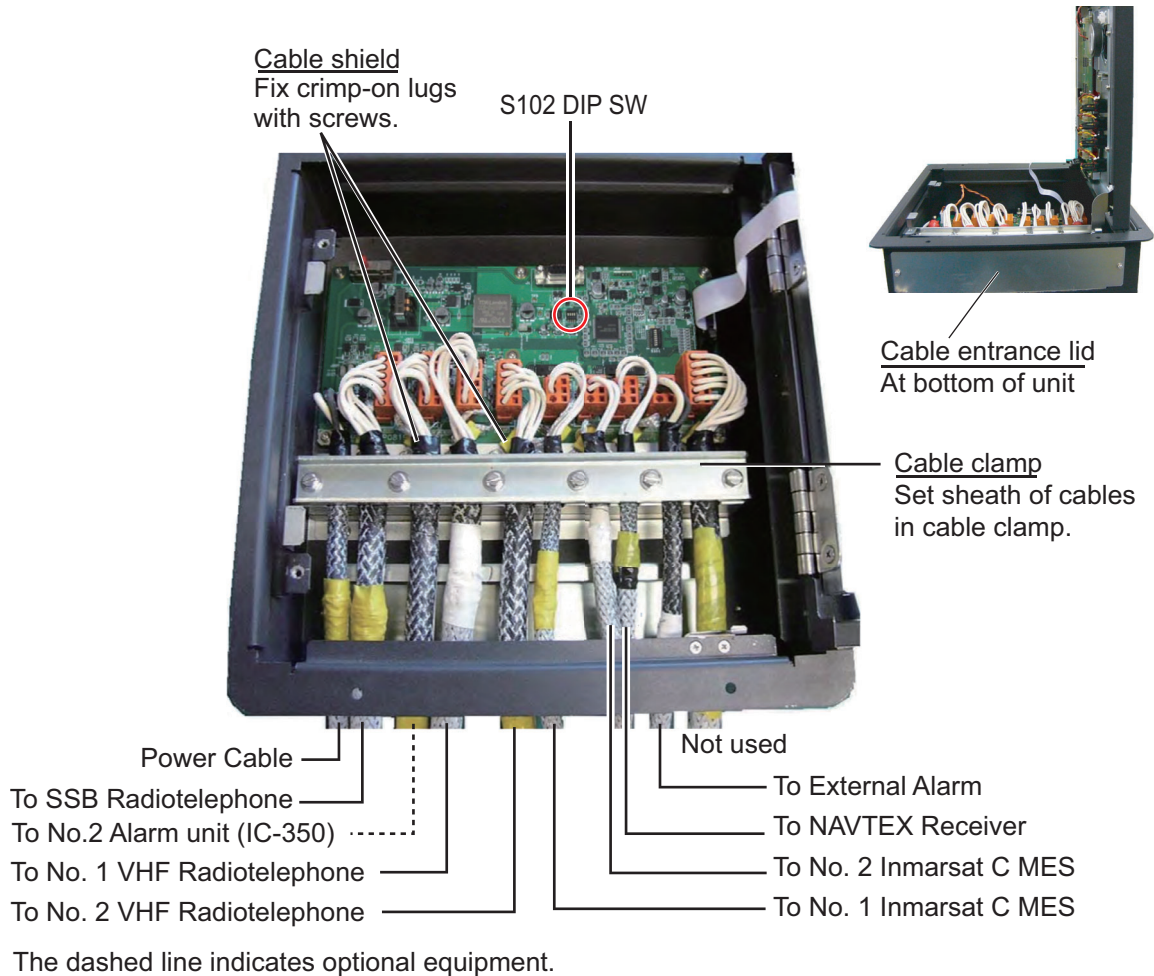

1. INSTALLATION

# 1.4 Settings

## How to set the external equipment

Set the DIP switch S101 on the PANEL Board (05P0820) according to equipment connected. All switches are in the OFF position in the factory setting. Set a switch in the ON position if the related equipment is not connected.

		OFF	ON
1	No.1 VHF	ENABLE	DISABLE
2	No.2 VHF	ENABLE	DISABLE
3	MF/HF	ENABLE	DISABLE
4	No.1 INMARSAT	ENABLE	DISABLE
5	No.2 INMARSAT	ENABLE	DISABLE
6	NAVTEX	ENABLE	DISABLE
7	NAVTEX SEL	NC	NO
8			

#1-#6  
ON: Equipment not connected.  
OFF: Equipment connected.

← #7  
NX-700: OFF  
NX-500: ON

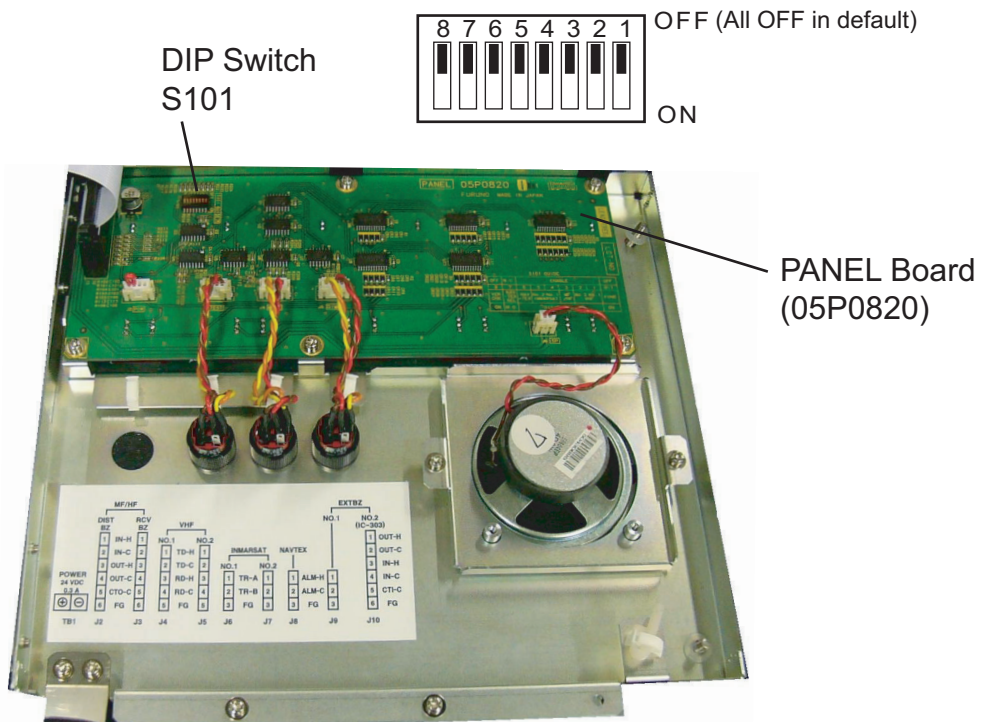

### “SPARE” sticker

If you connect one Inmarsat C only, put the “SPARE” stickers on No.2 INMARSAT indications for LED lamp and DISTRESS button. The “SPARE” stickers are attached on the reverse side of the operation panel.

**Short plug position and SSB radiotelephone**

FS-1570/2570/5070: Change the position of the short plug of pin headers J101, J203, J204, J205, J301, J302 as shown in the figure below. FS-1575/2575/5075: No adjustment is necessary; use the default positions. (All short plugs are between #2 & 3.)

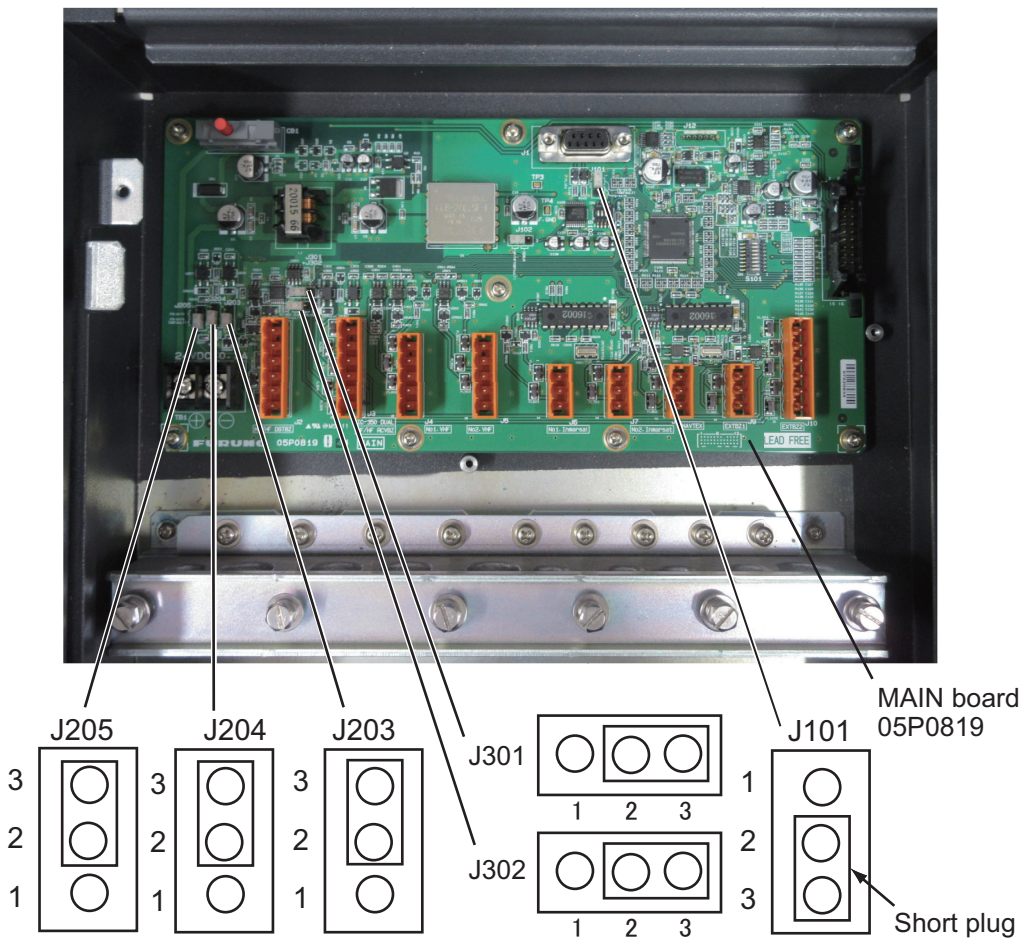

For FS-1570/2570/5070, set the short plugs of J205, J204, J203, J301, J302 and J101 between pins 2 & 3. J102 is for program update only to set between pins 2 & 3.

1. INSTALLATION

**The setting for dual IC-350 (option)**

Set the dip switch S102 on the MAIN pcb for IC-350 dual installation.

- Set the dip switch #1 on S102 to 'ON' for No.1 IC-350. (#2 to #4: OFF)
  - Set the dip switch #1 and #2 on S102 to 'ON' for No.2 IC-350. (#3 and #4: OFF)
- Refer to the figure on page 4 for the location of S102.

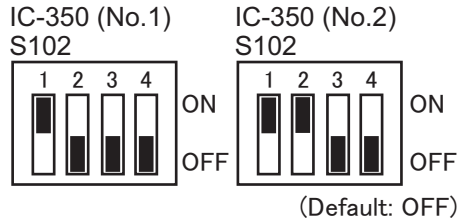

- Set the both dip switch S101 of No. 1 and No. 2 IC-350s to same condition. Refer to the figure on page 5 for the location of S101.
- Shorten the pin-header #1 and #2 of J301 and J302 on the main board 05P0819 as shown in the following figure. (Default setting)

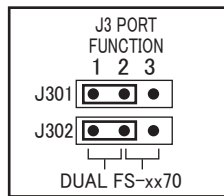

Detail for J301/302

Refer to the sticker on the behind of lid for jumper switch settings.

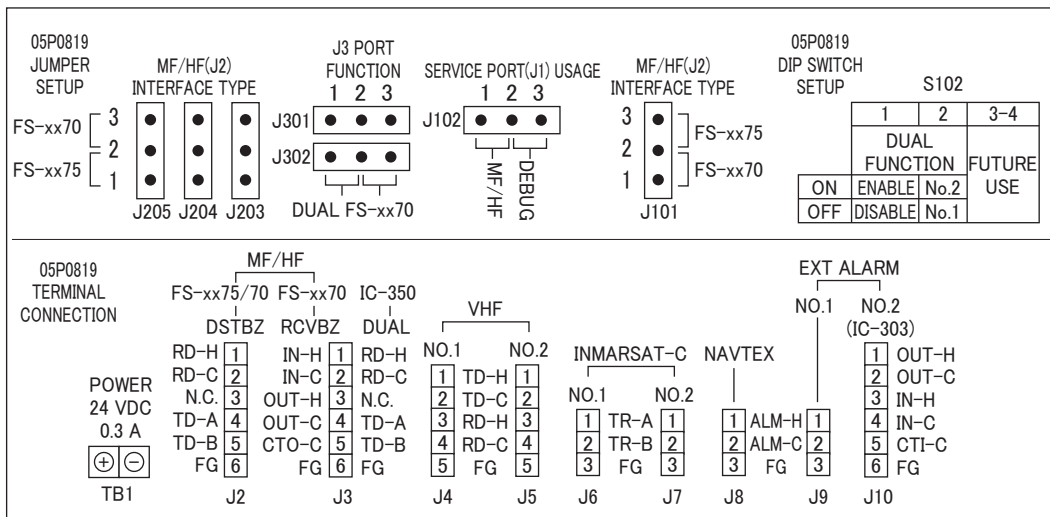



## 2. OPERATION

### 2.1 Controls and Indicators

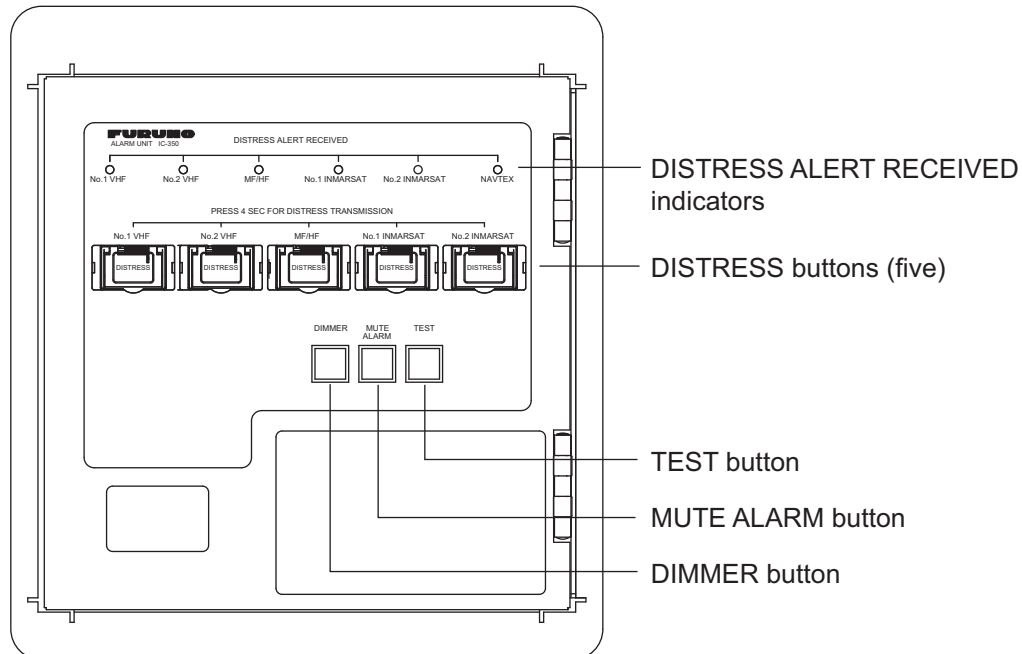

VHF: VHF radiotelephone  
MF/HF: SSB radiotelephone  
INMARSAT: Inmarsat-C Mobile Earth Station  
NAVTEX: Navtex Receiver

### 2.2 How to Set the Unit to Stand-by

1. Supply power from a power source which is backed-up by radio battery to turn on the IC-350. All buttons in the IC-350 illuminate. Run the IC-350 while underway. A DISTRESS button does not illuminate if the equipment name shown above the button is not connected. If a DISTRESS button does not illuminate when the equipment is connected, check the DIP switch setting or the lamp inside the button. See page 6.
2. Push the DIMMER button to adjust the illumination for the buttons. There are seven illumination settings. Pressing the button repeatedly increases the illumination to maximum, then reduces the illumination to minimum (off). When the equipment is re-started, the illumination starts with the previous setting.  
**Note:** At minimum setting, the illumination for the distress buttons is not turned off.

## 2. OPERATION

### 2.3 When You Receive a Distress Signal

When you receive a distress signal, the related DISTRESS indicator flashes and the two-tone alarm sounds. The volume of the alarm gets louder after five seconds.

To stop the audio alarm, push the MUTE ALARM button. The related DISTRESS indicator then illuminates. The indicator turns off when the distress signal is stopped.

### 2.4 How to Send a Distress Signal

If **YOUR ship is in distress**, send a distress signal and do distress communications with a coast station by radiocommunications. The IC-350 has five distress buttons. Use the No.1 VHF button (leftmost DISTRESS button) to send a distress signal in normal use.

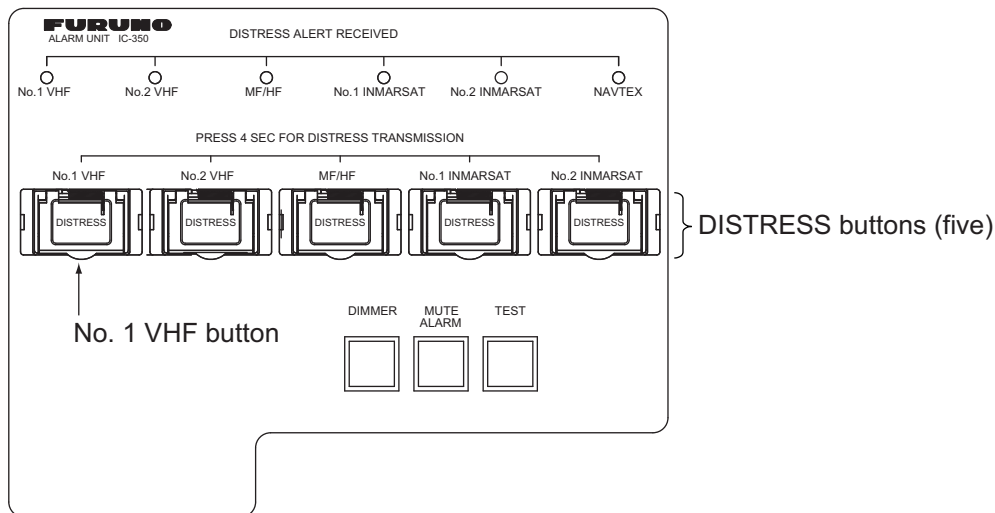

To send a distress signal, open the cover of the correct DISTRESS button and push the button more than four seconds. In the first three seconds, the button flashes and the speaker releases three beeps. The button then illuminates and the distress signal is sent. Do distress communications with a coast station by the same communications equipment used to send the distress signal.

If you release a DISTRESS button within three seconds after you pressed the button, the distress signal is not sent. If you accidentally sent a distress signal, contact a coast station to report accidental distress transmission. Contact the coast station by the same communications equipment used to send the distress signal.

If a DISTRESS button does not flash when the button is pushed more than four seconds, the related communications equipment is turned off. If a DISTRESS button does not illuminate, related communications equipment is not connected, and the distress signal is not sent.

If you accidentally sent the distress signal with the MF/HF DISTRESS button and powered off the SSB radiotelephone after realizing the mis-transmission, the lamp in the DISTRESS button continues to illuminate. If this happens, long-push the MUTE ALARM button to restore normal operation.

**Note:** If you accidentally sent the distress signal, refer to the operator's manual of the radiocommunications equipment for the procedure to cancel the distress signal.

## 2.5 How to Operate the Dual Alarm Unit

You can operate No.2 alarm unit from remote location by dual alarm unit installation. When the No.2 alarm unit is installed, do the operation as follows.

Purpose	Operation
Turn the power on	Both equipment can turn on first.
Resceive distress signal	Two units resceive the signal simulteneously and lights the lamps and buzzer alarm occurs on each equipment.
Send distress signal	Press the DISTRESS button on one of the two alarm units. The earlier pressing has effect to send a distress signal.
Dimmer control	Independently.
Diagnose the system	Independently.
External alarm output	Both equipment ports are enabled.
Communication error	If the communication is failed between No.2 and No.1 alarm unit, No.2 alarm unit alert is generated. The communication error between No.1 alarm unit and radio transceivers is same as only one alarm unit installation. The alarm buzzer can be stopped with short press of mute alarm buttom from No.2 alarm unit.

# 3. MAINTENANCE

---

## NOTICE

**Do not apply paint, anti-corrosive sealant or contact spray to coating or plastic parts of the equipment.**

Those items contain organic solvents that can damage coating and plastic parts, especially plastic connectors.

## 3.1 Maintenance

Check the points shown below once a month to help keep the equipment in good condition.

Item	Check point
Cables	Check cables for damage.
Screws on chassis	Check that screws are correctly fastened.
Ground	Check for corrosion.
Voltage	Check that the voltage is within the rating of the equipment. (The voltage at the power terminal is 20.4 - 31.6 VDC)

## 3.2 How to Clean the Equipment

Remove dust from the equipment with a soft and dry cloth. To remove dirt, use a moist cloth. Do not use chemical cleaners as those types of cleaners can remove paint and markings.

### 3.3 Circuit Breaker

The circuit breaker inside the IC-350 activates for equipment problems or high voltage. The button on the breaker comes out when the breaker activates. Push the button to reset the breaker. If you cannot turn ON the power (from the ship's switchboard), contact a FURUNO agent or dealer for instruction.

Circuit breaker



### 3.4 Troubleshooting

Problem	Possible cause	Remedy
You cannot turn ON the unit	<ul style="list-style-type: none"> <li>The circuit breaker inside the unit has activated.</li> <li>The input voltage is not within the voltage rating.</li> </ul>	<ul style="list-style-type: none"> <li>Press the button on the breaker to restore normal operation.</li> <li>Check the input voltage.</li> </ul> <p>If you cannot turn ON the equipment, contact a FURUNO agent or dealer for instruction.</p>

### 3.5 Equipment Test

Push the TEST button to test the two-tone signal and the illumination for the buttons. The test completes in approximately three seconds. All the buttons illuminate and the two-tone signal sounds.

#### CAUTION

You cannot send or receive a distress signal during the test.

**SPECIFICATIONS OF ALARM UNIT  
IC-350**

IC-350 is a GMDSS Distress Alarm Panel that is normally installed at conning position. Pressing the button on the panel transmits the distress alert. When the incoming distress or urgency call is received, the panel generates audible and visible alarms. The buttons on panel are clearly and visibly identified.

**1 GENERAL**

- 1.1 Indication of receive      LED illumination and audible alarm generated when distress callings are received (SAR message for Navtex receiver)
- 1.2 Nature of distress
  - Distress button      LED illumination independently for each equipments
  - Audible alarm      Synchronized with LED behavior (continuous/ intermittent/ halt)
- 1.3 External alarm
  - Alarm 1      Distress alert indication, Photo-MOS relay contact, normal close  
Max. 80 mA, 50 V
  - Alarm 2      Incoming indicator (IC-303-DSC) for SSB radiotelephone

**2 INTERFACE**

- 2.1 I/O port
  - SSB radiotelephone      FS-1575/2575/5075
  - Marine VHF radiotelephone      FM-8900S (2 sets)
  - Inmarsat-C MES      FELCOM18
  - Navtex receiver      NX-700A/B
  - External alarm      General: 1 port, DSC: 1 port
- 2.2 Control panel      TEST/ ALARM MUTE/ DIMMER/ DISTRESS
- 2.3 LED indication      DISTRESS call, 6 sets
- 2.4 Speaker      Receiving alarm/ Audible alarm

**3 POWER SUPPLY**

- 3.1 Alarm unit      24 VDC: 0.15A
- 3.2 AC/DC power supply unit (option)
  - PR-240      100-115/200-230 VAC, 1 phase, 50/60Hz, 24 VDC backup
  - PR-241      100-230 VAC, 1 phase, 50-60Hz, 24 VDC backup
- 3.3 Rectifier (PR-62, option)      100/110/220/230 VAC, 1 phase, 50/60Hz

**4 ENVIRONMENTAL CONDITION**

- 4.1 Ambient temperature      -15°C to +55°C
- 4.2 Relative humidity      95% at 40°C
- 4.3 Degree of protection      Front panel: IP22
- 4.4 Vibration      IEC 60945

**5 COATING COLOR**

N2.5

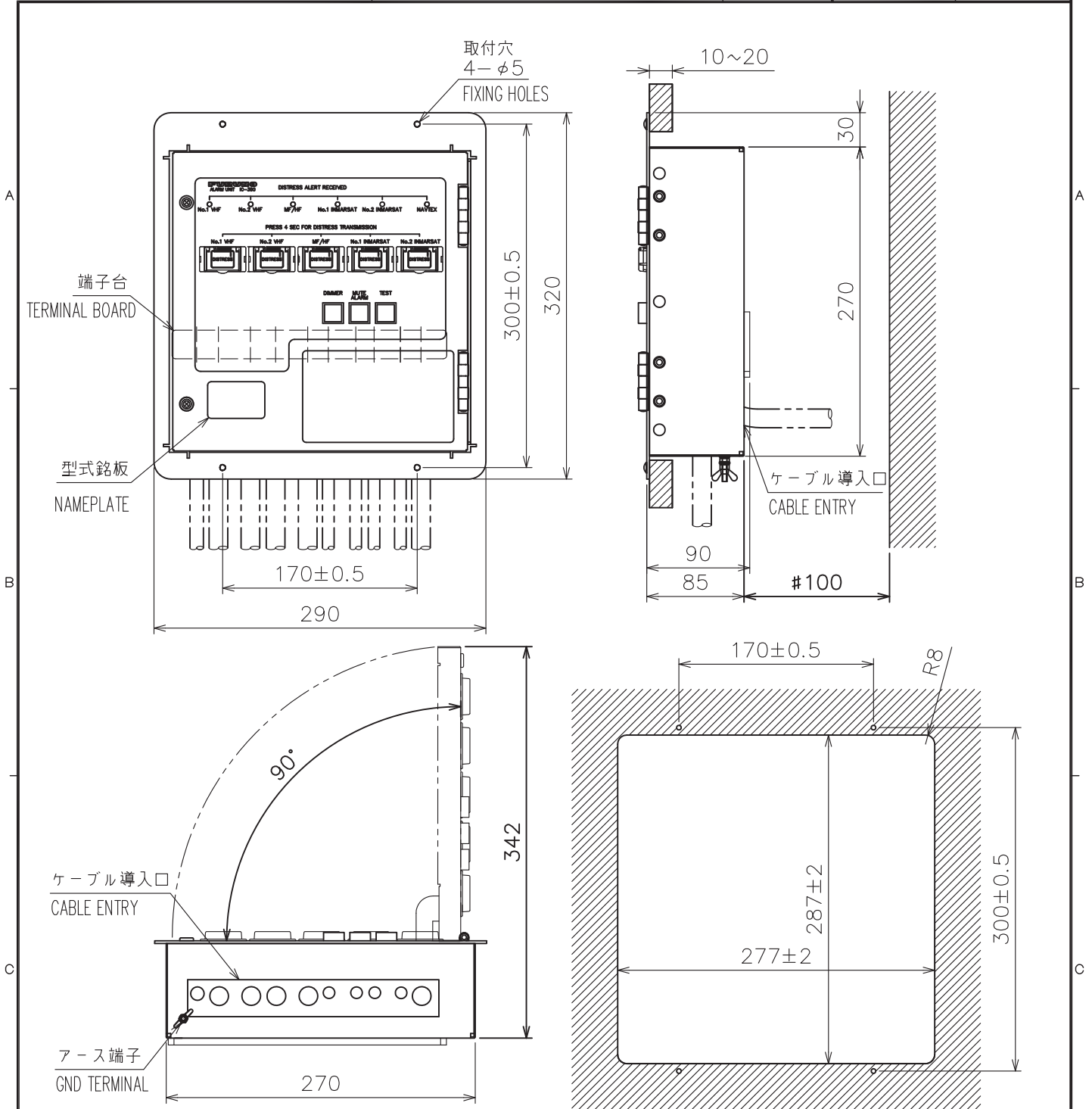

取付穴寸法図 (参考図)  
CUTOUT DIMENSIONS (REFERENCE)

注記

- 1) 指定外の寸法公差は表1による。
- 2) #印寸法は最小値とする。
- 3) 取付用ネジはトラスタップネジ呼び径4×20を使用のこと。

NOTE

1. TABLE 1 INDICATES TOLERANCE OF DIMENSIONS WHICH IS NOT SPECIFIED.
2. #: MINIMUM SERVICE CLEARANCE.
3. USE TAPPING SCREWS  $\phi 4 \times 20$  FOR FIXING THE UNIT.

表1 TABLE 1

寸法区分 (mm) DIMENSION	公差 (mm) TOLERANCE
$L \leq 50$	$\pm 1.5$
$50 < L \leq 100$	$\pm 2.5$
$100 < L \leq 500$	$\pm 3$

DRAWN	25/Sep/08 T.YAMASAKI	TITLE	IC-350
CHECKED	25/Sep/08 T.TAKENO	名称	アラームユニット (埋込装備)
APPROVED	30/Sep/08 R.Esumi		外寸図
SCALE	1/5 MASS 4.7 ±10% kg	NAME	ALARM UNIT (FLUSH MOUNT)
DWG.No.	C5665-G01-C	REF.No.	05-099-250G-2
		OUTLINE DRAWING	

4

3

2

1

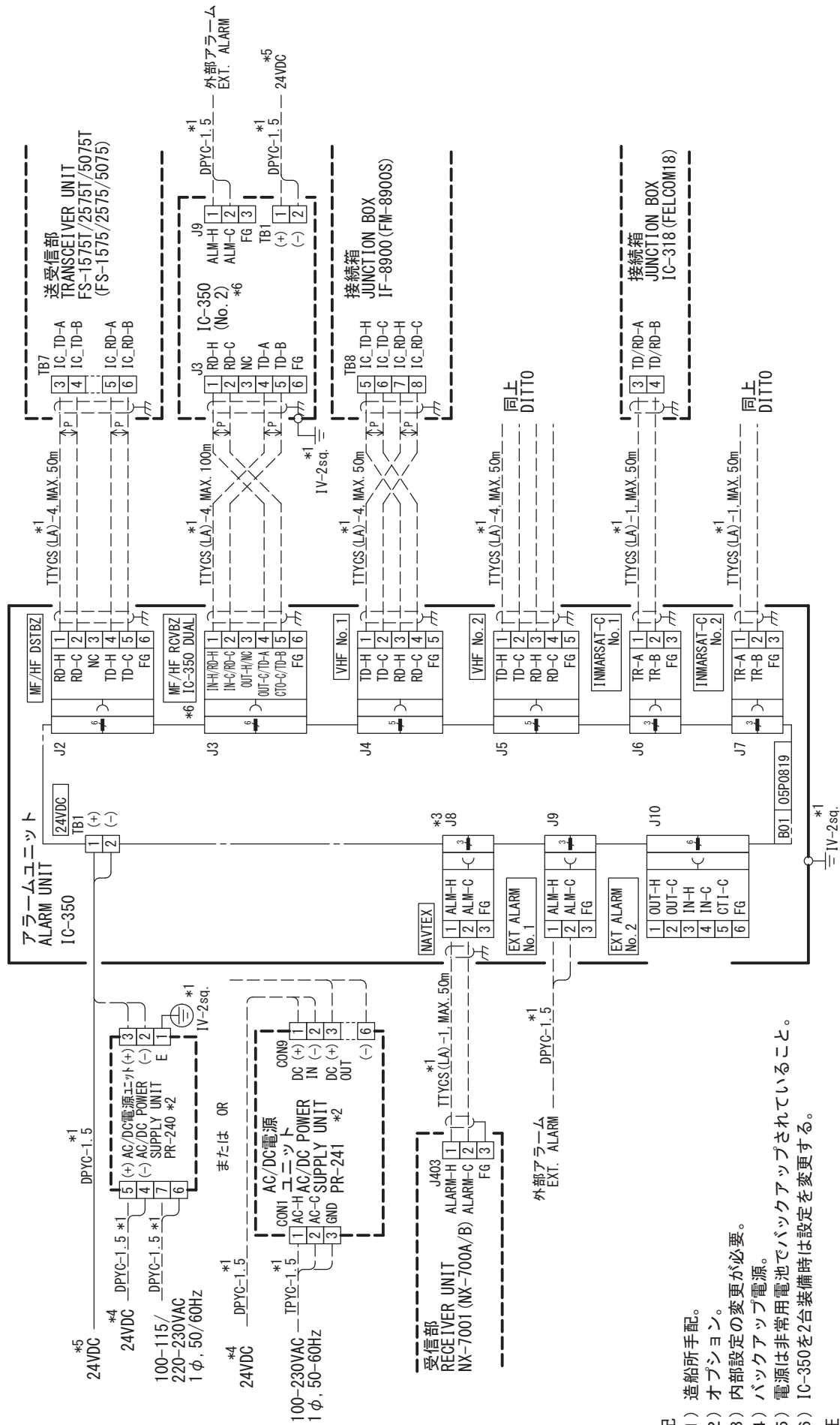

A

B

C

**注記**

- \*1) 造船所手配。
- \*2) オプション。
- \*3) 内部設定の変更が必要。
- \*4) バックアップ電源。
- \*5) 電源は非常用電池でバックアップされていること。
- \*6) IC-350を2台装備時は設定を変更する。

**NOTE**

- \*1: SHIPYARD SUPPLY.
- \*2: OPTION.
- \*3: INTERNAL SETTING REQUIRED.
- \*4: BACK-UP BATTERY.
- \*5: POWER SOURCE REQUIRES BACK-UP BATTERY.
- \*6: CHANGE THE SETTING FOR IC-350 DUAL INSTALLATION.

DRAWN	15/Sep/2021 U. PODDAR	TITLE	IC-350
CHECKED	15/Sep/2021 T. YAMASAKI	名称	アラームユニット
APPROVED	27/Sep/2021 H. MAKI		相互結線図
SCALE	1/25	NAME	ALARM UNIT
DWG No.	C5665-001-H	REF. No.	05-099-2002-3
			INTERCONNECTION DIAGRAM





## Declaration of Conformity



We **FURUNO ELECTRIC CO., LTD.**

(Manufacturer)

9-52 Ashihara-Cho, Nishinomiya City, 662-8580, Hyogo, Japan

(Address)

declare under our sole responsibility that the product

**ALARM UNIT IC-350**

(Model name, type number)

to which this declaration relates conforms to the following standard(s) or other normative document(s)

### EU

EMC Directive 2014/30/EU

IEC 60945 Ed.4.0: 2002

For assessment, see

- Test report  
Furuno Labotech International Co., Ltd.  
FLI 12-08-024 Rev. A, 11 Jun 2008

### UK

SI 2016 No.1091 EMC Regulations 2016 as amended

EN 60945: 2002

For assessment, see

- Test report  
Furuno Labotech International Co., Ltd.  
FLI 12-08-024 Rev. A, 11 Jun 2008

(title and/or number and date of issue of the standard(s) or other normative document(s))

On behalf of Furuno Electric Co., Ltd.

Nishinomiya City, Japan  
26 July 2021

(Place and date of issue)

Akihiko Kanechika  
Department General Manager  
Quality Assurance Department

(name and signature or equivalent marking of authorized person)





**ECF**

(Elemental Chlorine Free)

The paper used in this manual  
is elemental chlorine free.

**FURUNO ELECTRIC CO., LTD.**

9-52 Ashihara-cho,  
Nishinomiya, 662-8580, JAPAN

• FURUNO Authorized Distributor/Dealer

All rights reserved. Printed in Japan

Pub. No. OME-56650-F

(REFU ) IC-350

A : JUN. 2008

F : JUN. 28, 2022



0 0 0 1 6 9 2 0 4 1 5