

FURUNO

OPERATOR'S MANUAL

DOPPLER SONAR CURRENT INDICATOR

Model

CI-88

FURUNO ELECTRIC CO., LTD.

9-52 Ashihara-cho,
Nishinomiya, 662-8580, JAPAN

• FURUNO Authorized Distributor/Dealer

All rights reserved. Printed in Japan

Pub. No. OME-72530-D1

(ETMI) CI-88

A : OCT. 2003
D1 : NOV. 09, 2022



0 0 0 1 4 8 0 2 6 1 3

IMPORTANT NOTICES

General

- This manual has been authored with simplified grammar, to meet the needs of international users.
- The operator of this equipment must read and follow the instructions in this manual. Wrong operation or maintenance can void the warranty or cause injury.
- Do not copy any part of this manual without written permission from FURUNO.
- If this manual is lost or worn, contact your dealer about replacement.
- The contents of this manual and the equipment specifications can change without notice.
- The example screens (or illustrations) shown in this manual can be different from the screens you see on your display. The screens you see depend on your system configuration and equipment settings.
- Save this manual for future reference.
- Any modification of the equipment (including software) by persons not authorized by FURUNO will void the warranty.
- The following concern acts as our importer in Europe, as defined in DECISION No 768/2008/EC.
 - Name: FURUNO EUROPE B.V.
 - Address: Siriusstraat 86, 5015 BT, Tilburg, The Netherlands
- The following concern acts as our importer in UK, as defined in SI 2016/1025 as amended SI 2019/470.
 - Name: FURUNO (UK) LTD.
 - Address: West Building Penner Road Havant Hampshire PO9 1QY, U.K.
- All brand, product names, trademarks, registered trademarks, and service marks belong to their respective holders.

How to discard this product

Discard this product according to local regulations for the disposal of industrial waste. For disposal in the USA, see the homepage of the Electronics Industries Alliance (<http://www.eiae.org/>) for the correct method of disposal.

How to discard a used battery

Some FURUNO products have a battery(ies). To see if your product has a battery, see the chapter on Maintenance. If a battery is used, tape the + and - terminals of the battery before disposal to prevent fire, heat generation caused by short circuit.

In the European Union

The crossed-out trash can symbol indicates that all types of batteries must not be discarded in standard trash, or at a trash site. Take the used batteries to a battery collection site according to your national legislation and the Batteries Directive 2006/66/EU.

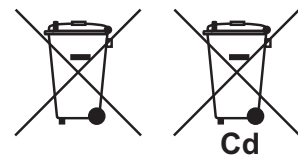

In the USA

The Mobius loop symbol (three chasing arrows) indicates that Ni-Cd and lead-acid rechargeable batteries must be recycled. Take the used batteries to a battery collection site according to local laws.

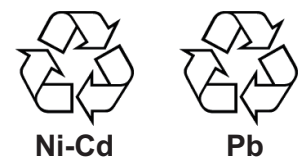



In the other countries

There are no international standards for the battery recycle symbol. The number of symbols can increase when the other countries make their own recycle symbols in the future.





SAFETY INSTRUCTIONS

The operator and installer must read the applicable safety instructions before attempting to install or operate the equipment.

 DANGER	Indicates a potentially hazardous situation which, if not avoided, will result in death or serious injury.
 WARNING	Indicates a potentially hazardous situation which, if not avoided, could result in death or serious injury.
 CAUTION	Indicates a potentially hazardous situation which, if not avoided, can result in minor or moderate injury.

 Warning, Caution	 Prohibitive Action	 Mandatory Action
--	--	--

 **WARNING**

 **ELECTRICAL SHOCK HAZARD**
Do not open the equipment.

Only qualified personnel should work inside the equipment.

Immediately turn off the power at the switchboard if water leaks into the equipment or something is dropped in the equipment.

Continued use of the equipment can cause fire or electrical shock. Contact a FURUNO agent for service.

Do not disassemble or modify the equipment.

Fire, electrical shock or serious injury can result.

Do not place liquid-filled containers on the top of the equipment.

Fire or electrical shock can result if a liquid spills into the equipment.

 **WARNING**

Keep heater away from equipment.

A heater can melt the equipment's power cord, which can cause fire or electrical shock.

Use the proper fuse.

Use of a wrong fuse can damage the equipment.

Do not operate the equipment with wet hands.

Electrical shock can result.

Immediately turn off the power at the switchboard if the equipment is emitting smoke or fire.

Continued use of the equipment can cause fatal damage to the equipment. Contact a FURUNO agent for service.

Make sure no rain or water splash leaks into the equipment.

Fire or electrical shock can result if water leaks in the equipment.



CAUTION

Check the zinc plate (anticorrosion measure) regularly for corrosion and replace it when the ship is drydocked.

Corrosion may occur. As a result the transducer may fall out, allowing water to leak inside the vessel.

Do not use the equipment for other than its intended purpose.

Damage to the equipment or bodily injury may result if the equipment is misused.

Do not transmit with the transducer out of water, when drydocked, etc.

The transducer may become damaged.

Turn off the power at the switchboard immediately whenever you feel the equipment is abnormal.

Turn off the equipment at the switchboard if it becomes warm or is making strange noises. Contact your dealer at your earliest convenience.

WARNING LABEL

A warning label is attached to the transceiver and monitor units. Do not remove the labels. If a label is missing or damaged, contact a FURUNO agent or dealer about replacement.

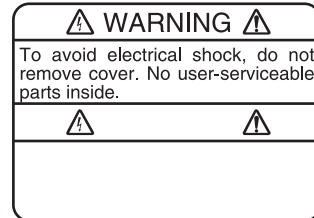

Transceiver Unit
Name: Warning Label (1)
Type: 86-003-1011-1
Code No.: 100-236-231

Monitor Unit
Name: Warning Label (2)
Type: 03-129-1001-1
Code No.: 100-236-741

TFT LCD

The high quality TFT LCD displays 99.99% of its pixels. The remaining 0.01% of pixels may light or dropout, however this is not an indication of malfunction; it is a characteristic of the LCD.

TABLE OF CONTENTS

FOREWORD	vi
SYSTEM CONFIGURATION	viii
DISPLAY EXAMPLE	ix
1. OPERATIONAL OVERVIEW	1-1
1.1 Controls.....	1-1
1.2 Turning the Power On/Off	1-2
1.3 Adjusting LCD Brilliance.....	1-2
1.4 Choosing a Display	1-3
1.4.1 Tide vector display	1-3
1.4.2 Ship's speed display	1-4
1.4.3 Graph display	1-4
1.4.4 Course plot display.....	1-5
1.4.5 Text display	1-5
1.4.6 Echo level display	1-6
1.5 Setting Measuring Depths.....	1-7
1.6 Choosing Speed Tracking Mode.....	1-8
1.7 Choosing the Range	1-9
2. INTERPRETING THE DISPLAYS	2-1
2.1 Tide Vector Display	2-1
2.2 Ship's Speed Display	2-5
2.3 Graph Display	2-7
2.4 Course Plot Display.....	2-9
2.5 Numeric Display	2-10
2.6 Echo Level Display.....	2-10
2.7 Error Display	2-11
3. CUSTOMIZING THE SYSTEM	3-1
3.1 Menu Operation	3-1
3.2 Function Keys	3-3
3.2.1 Programming the function keys.....	3-3
3.2.2 Using the function keys.....	3-3
3.3 MENU 1 Menu.....	3-4
3.4 MENU 2 Menu.....	3-6
3.4.1 MODE menu	3-6
3.4.2 DISP1 menu.....	3-7
3.4.3 DISP2 menu.....	3-9
3.5 ALARM Menu.....	3-11
3.5.1 Alarm types	3-11
3.5.2 Setting/Canceling tide speed, tide direction, tide differential and ship's speed alarms	3-12
3.5.3 Setting the trip alarm	3-14
3.5.4 Disabling/enabling the audible alarm	3-15
3.5.5 Disabling an alarm	3-15
4. MAINTENANCE & TROUBLESHOOTING	4-1
4.1 Routine Maintenance	4-1
4.2 Replacing Fuses	4-2
4.3 Troubleshooting	4-3
4.4 Diagnostics.....	4-4

- 4.4.1 General test4-4
- 4.4.2 Panel test4-6
- 4.4.3 Test pattern4-7
- 4.5 Error Messages and Alerts4-8

- APPX. 1 MENU TREEAP-1**
- APPX. 2 TIDE MEASUREMENT IN NAV MODE.....AP-3**
- APPX. 3 PRINCIPLE OF OPERATION.....AP-6**
- APPX. 4 Tide, Nav-tide and Tide DifferentialAP-9**

- specifications SP-1**

- INDEX IN-1**

FOREWORD

A Word to the Owner of the CI-88

Congratulations on your choice of the FURUNO CI-88 Doppler Sonar Current Indicator. We are confident you will see why FURUNO has become synonymous with quality and reliability.

Since 1948, FURUNO Electric Company has enjoyed an enviable reputation for innovative and dependable marine electronics equipment. This dedication to excellence is furthered by our extensive global network of agents and dealers.

Your current indicator is designed and constructed to meet the rigorous demands of the marine environment. However, no machine can perform its intended function unless installed, operated and maintained properly. Please carefully read and follow the recommended procedures for operation and maintenance.

Thank you for considering and purchasing FURUNO equipment.

Features

- With heading data from a gyrocompass, satellite compass, etc., the absolute movements of tide measuring layers is displayed, in colors.
- When ground (bottom) reference is not available acoustically; namely, ship is in deep water, this equipment provides absolute movements of measuring layers by receiving position (or speed) data from a GPS navigator and heading data from a gyrocompass or satellite compass.
- Single-mold transducer plus compact monitor unit, control unit, transceiver unit and junction box (option) permit installation on small vessels.
- Data is displayed on a bright, non-fading 10.4" TFT LCD. Background color is selectable from three colors.
- Commercially available monitor may be used in lieu of the LCD monitor.
- Six display modes to discern tide movement from a variety of angles.
- Logical keyboard layout and menu structure for intuitive operation. Function key provides short-cut menu operation.
- Triple-beam system for automatic error compensation against pitching and rolling.
- Echo level continuously displayed on the screen, for monitoring signal conditions on three sounding beams.
- Bottom echo can be found using external depth data. Further, the bottom echo can be acquired manually by monitoring the echo level display. This is useful when in deep seas, air bubbles block reception of the bottom echo, or a thick layer of plankton or a large fish school is mistakenly tracked as the bottom echo.
- Various alarms: tide, tide differential, speed, trip, etc. Audible and visual alerts are released if alarm condition is violated.
- Graph display shows past current data.
- Water temperature graph helps locate current rip. (Temperature sensor required.)

CE/UKCA declaration

With regards to CE/UKCA declarations, please refer to our website (www.furuno.com), for further information about RoHS conformity declarations.

Disclosure of Information about China RoHS

With regards to China RoHS information for our products, please refer to our website (www.furuno.com).

SYSTEM CONFIGURATION

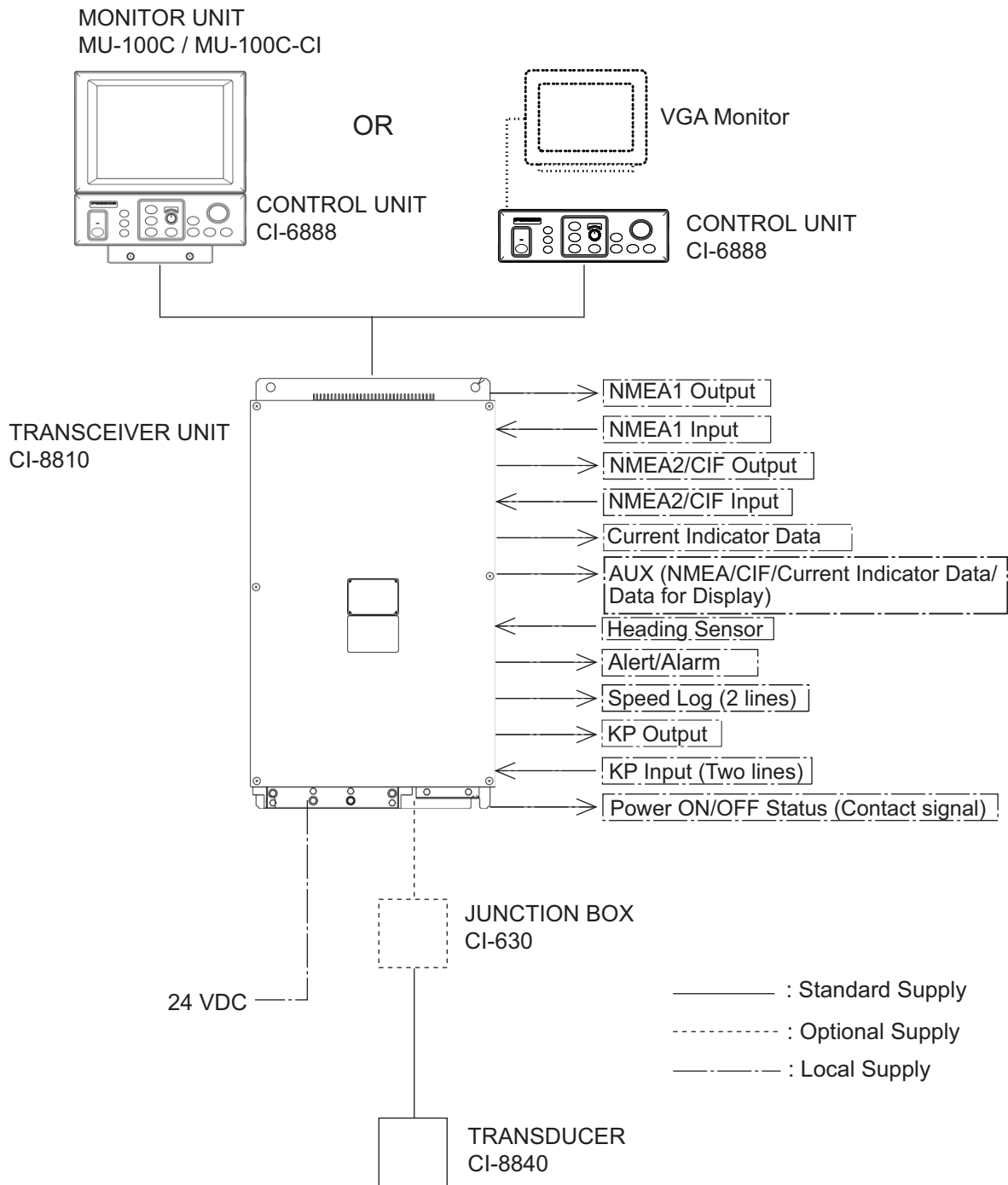

DISPLAY EXAMPLE

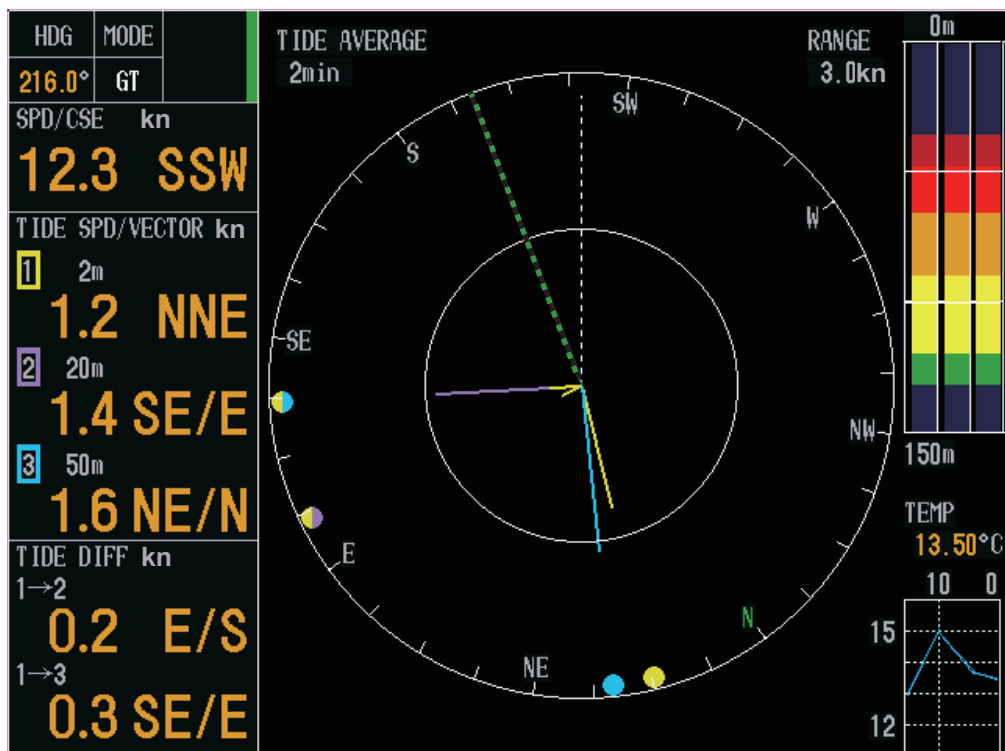

Tide vector display

Object and color

- Tide of layer 1: Yellow
- Tide of layer 2: Purple
- Tide of layer 3: Light-blue

- Own ship speed vector: Green (dashed)
- Heading line: White (dashed)

This page is intentionally left blank.

1. OPERATIONAL OVERVIEW

1.1 Controls

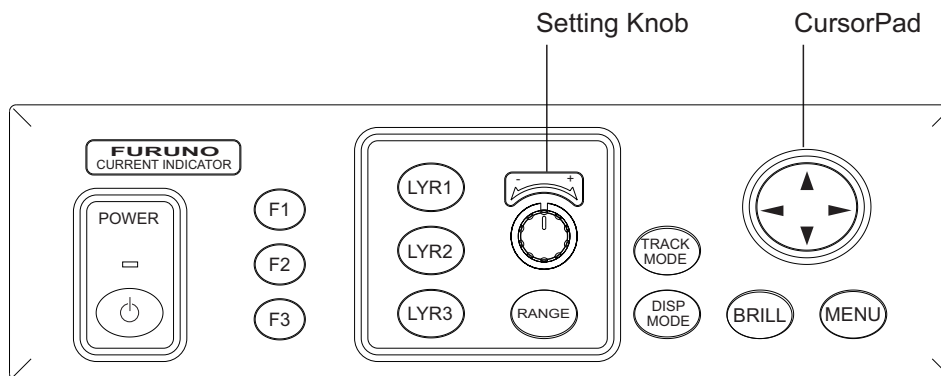

Control unit

Control	Function
POWER	Turns power on or off.
F1 - F3	Function keys (menu shortcut keys)
LYR1 - LYR3	Set tide measuring depths for respective layers.
Setting Knob	Sets measuring depth and range.
RANGE	Sets range. The range which can be set depends on mode.
TRACK MODE	Chooses tracking mode among ground, water (or nav) and auto.
DISP MODE	Chooses a display mode.
BRILL	Adjusts brilliance of LCD.
MENU	Opens and closes the menu.
CursorPad	<ul style="list-style-type: none"> • Chooses menu items and options. • Increases or decreases numerical setting on menus and pop-up windows. • Silences audible alarm.

1.2 Turning the Power On/Off

1. Press the **POWER** switch at the left hand side of the control unit to turn the power on. A beep sounds, the equipment turns on, and the lamp above the switch lights. The equipment conducts the diagnostic test to check for proper operation between the transceiver unit and the control unit and displays the results. After the diagnostic test is completed the last-used display appears.

```

CI-88
CI-6888
Starter. 6653000-xx.xx
Booter1. 6653001-xx.xx
Booter2. 6653001-xx.xx
VOL. 6653003-xx.xx
FPGA. 6653004-xx.xx
MEM. 1 2 3 4 OK

CI-8810
VOL. 6651003-xx.xx
TBL.
MEM. 1 2 3 4 5 6 7 8 OK
ANA. 12V;12.03V BV;110.0V
TRM. +25.02 deg.
DSW. 00 00 00 01
DSW. -- 00 00 01
    
```

XX: Program Version No.

Diagnostic test

Note: The example screens shown in this manual may not match the screens you see on your display. The screen you see depends on your system configuration and equipment settings.

2. To turn the power off, press the **POWER** switch again.

Note: The NAV mode measures tides in deep waters where ground tracking is not available. To use this function effectively, accurate heading data (from a gyrocompass, satellite compass) is necessary. For further details, see page AP-3.

1.3 Adjusting LCD Brilliance

You can adjust the brilliance of the FURUNO-supplied monitor as below. To adjust the brilliance of a commercial monitor, see its owner's manual.

1. Press the **BRILL** key to open the brilliance adjustment window.

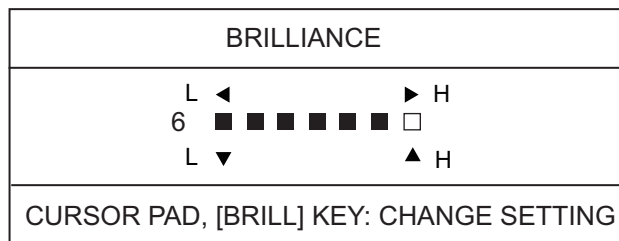

Brilliance adjustment window

Note: Execute the next step within five seconds after displaying the brilliance adjustment window. Otherwise the window is erased.

- Press ► or ▲ to raise the brilliance; ◀ or ▼ to lower it. The brilliance may also be adjusted by pressing the **BRILL** key. In this case, brilliance is adjusted cyclically: 0→1→...7→6...0→.

Note: You can adjust the backlighting for the control panel with PANEL DIMMER on the MENU 1 menu.

1.4 Choosing a Display

This current indicator has six main displays: tide vector display, ship's speed display, course plot display, text display, echo level display and graph display. You may choose a display by pressing the **DISP MODE** key.

1.4.1 Tide vector display

The tide vector display mainly shows tide speed and direction for three layers with a vector.

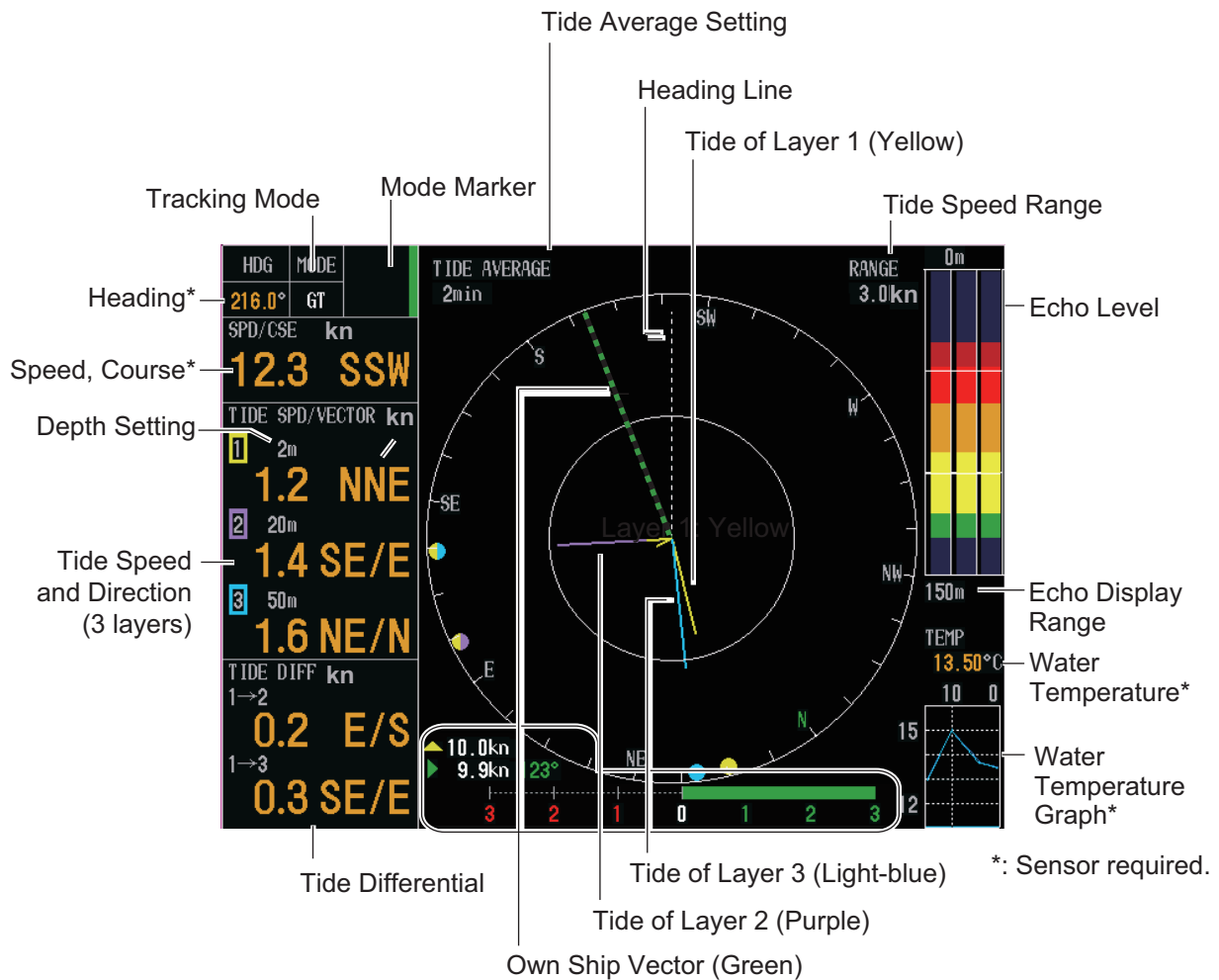

Tide vector display

1. OPERATIONAL OVERVIEW

1.4.2 Ship's speed display

The ship's speed display shows ship's fore-aft and port-starboard speeds in analog and digital form.

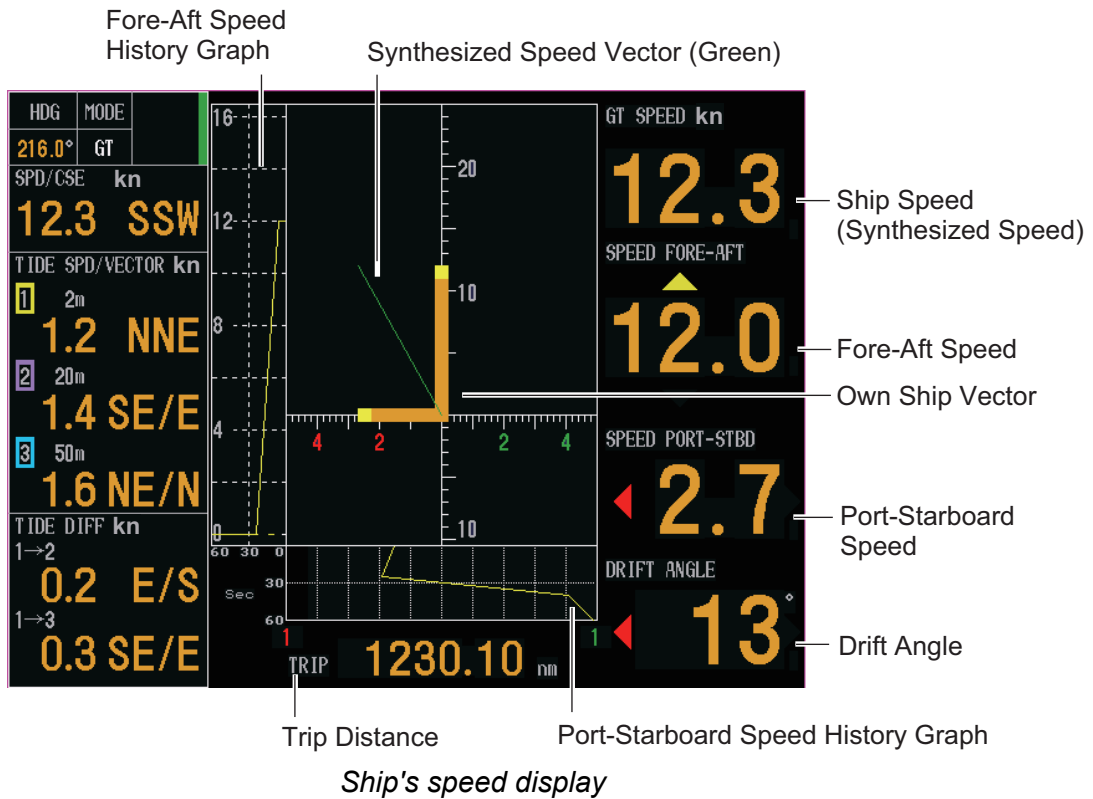

1.4.3 Graph display

The graph display plots water temperature and depth data in graph form.

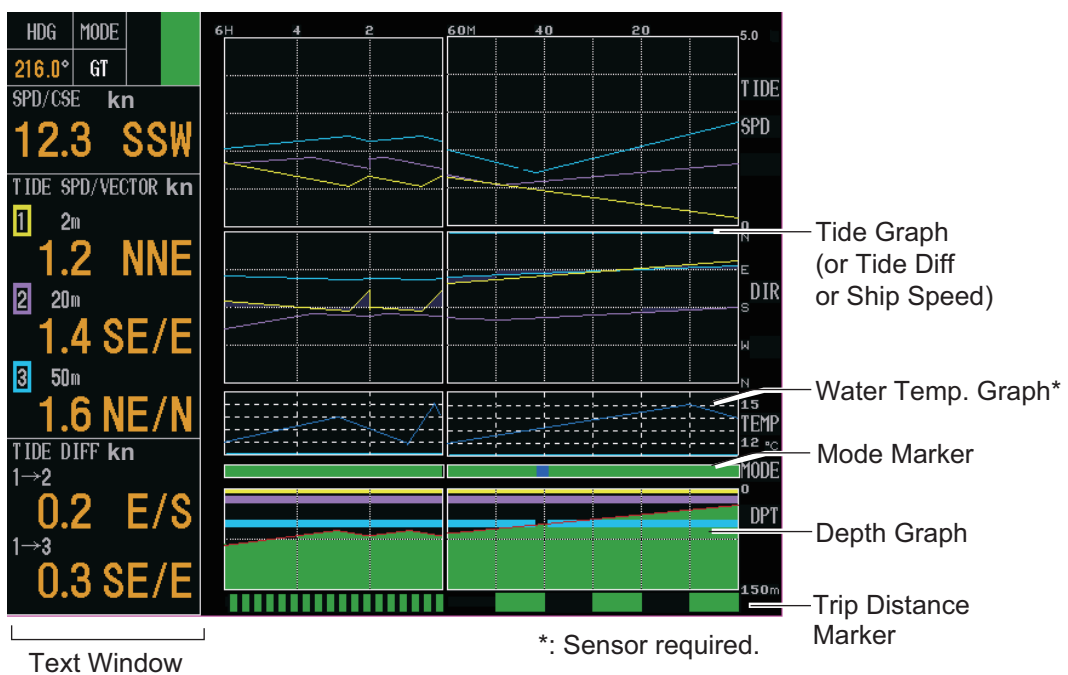

Graph display

1.4.4 Course plot display

The course plot display plots ship's track along with tide vectors.

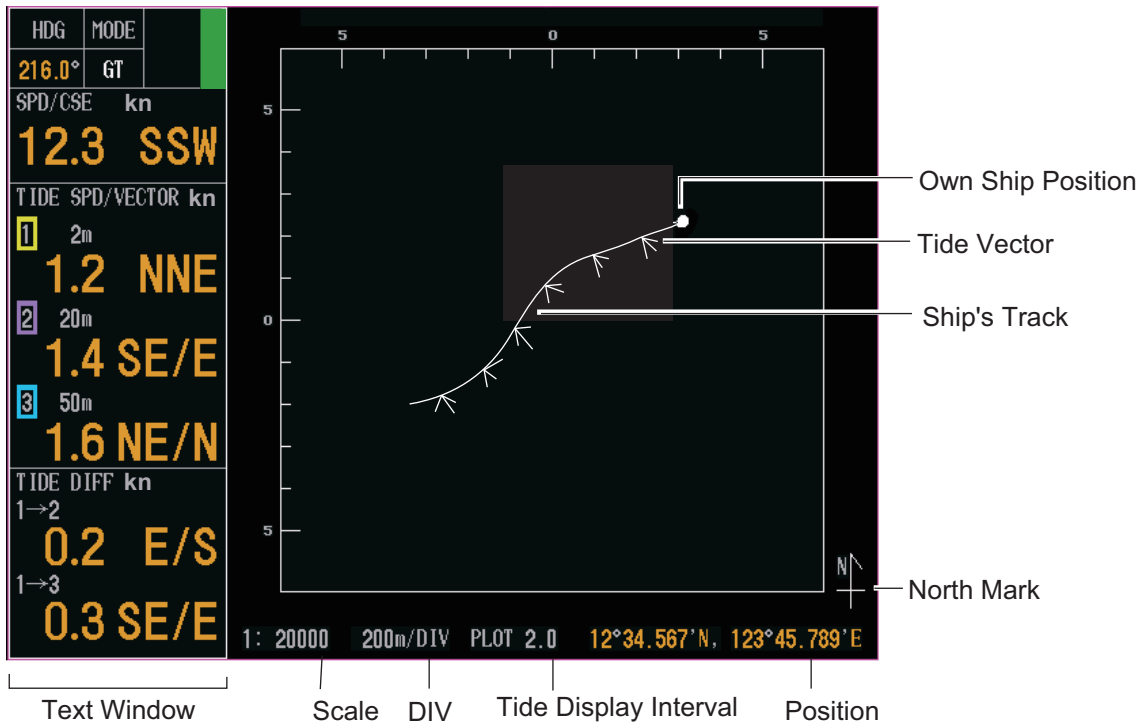

Course plot display

1.4.5 Text display

The text display provides various nav data in digital format.



*: Sensor required.

Text display

1.4.6 Echo level display

The echo level display shows the strength of the echoes captured by three sounding beams. Note that ECHO LEVEL in the MODE menu must be set to ON to show the echo level display.

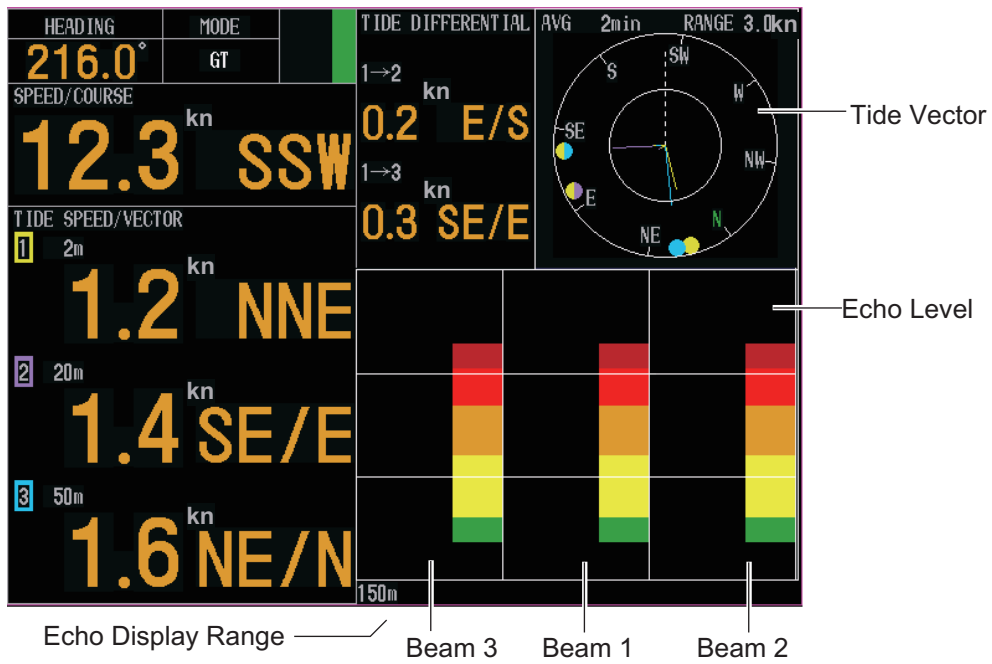

Echo level display

1.5 Setting Measuring Depths

Set the depths at which you wish to measure tide speed and direction as below. Note that layer 3 cannot be set when BTM TIDE TRACK in the MENU 1 menu is set to ON.

1. Press the **LYR1**, **LYR2** or **LYR3** key as appropriate to show the depth setting window.

SETTING DEPTH (LAYER1)
20 m (2-400)
KNOB OR CURSOR PAD: CHANGE SETTING

Depth setting window

2. Within five seconds after completing step 1, operate the Setting Knob or the CursorPad to set depth of measurement. The setting range is 2-250 (meters).

Setting Knob: Rotate clockwise to raise the range; counterclockwise to lower the range.

CursorPad: Press ► or ▲ to raise the range; ► or ▼ to lower the range.

1.6 Choosing Speed Tracking Mode

The tracking mode is available in ground tracking, water tracking, NAV and automatic.

Ground tracking: Absolute ship and tide movements based on ground and current (tide display (bottom echo must be present).

Water tracking: Ship and tide movements relative to near-surface water and tide differential between tide layers. (The pulse length in this mode must be NORMAL and depth greater than 40 m, or LONG pulse length and depth greater than 70 m.)

Nav: Ship's movement as measured by a navigation device and tide movements based on nav speed data.

Auto/external*: Uses ground tracking mode when bottom echo is available and switches to water tracking mode (or Nav mode) when bottom echo is lost. The bottom echo is continuously sought, and if re-acquired the ground tracking mode is restored. *EXT appears in the tracking mode window (top left corner) when DEPTH MODE in the OTHER menu (sub menu in the installation menu) is set to EXTERNAL.

To choose the tracking mode, press the **TRACK MODE** key. The tracking mode changes according to the setting (OFF or ON) of NAV MODE in the MENU 1 menu. The current tracking mode appears at the top left-hand corner on the screen.

OFF: The tracking mode changes cyclically in the sequence of ground tracking, water tracking and auto.

ON: The tracking mode changes cyclically in the sequence of ground tracking, nav and auto.

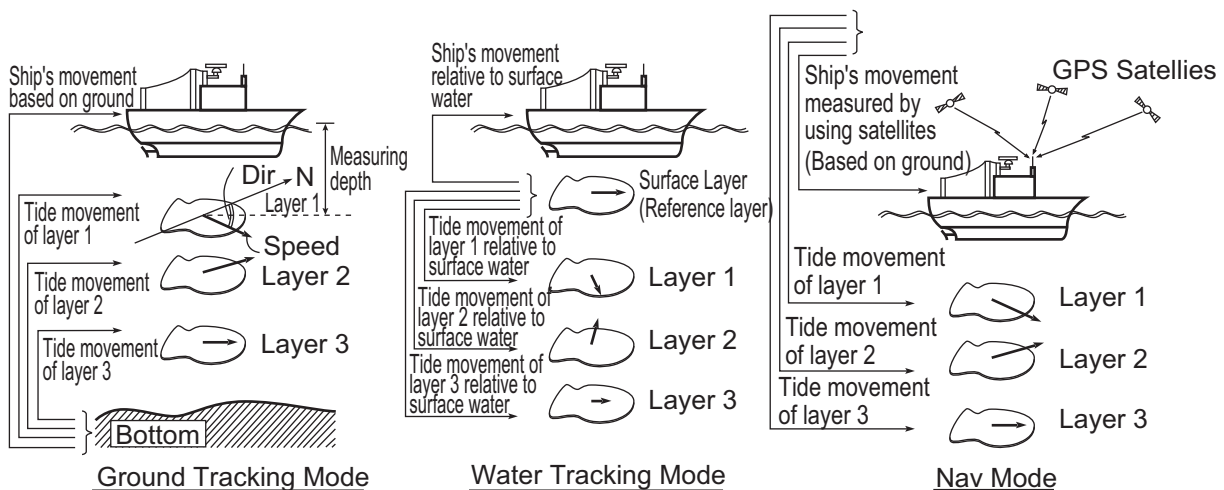

Tracking modes

1.7 Choosing the Range

You may choose the speed range as follows:

1. Press the **RANGE** key to show the range setting window.

TIDE SPEED RANGE
1.0 kn (0.5-10.0)
KNOB OR CURSOR PAD: CHANGE SETTING

Range setting window (example: range setting window for tide vector display)

2. Within five seconds after completing step 1, operate the Setting Knob or the CursorPad to set the range.

Setting Knob: Rotate clockwise to raise the range; counterclockwise to lower the range.

CursorPad: Press ► or ▲ to raise the range; ► or ▼ to lower the range.

Display and range to set

Display	Range
Tide vector	Tide speed range setting window appears. Set tide/tide differential range (radius of vector display ring) appropriately.
Ship's speed	The ship's speed range setting window shown depends on whether SCALE SYNC in the DISP2 sub menu is set to ON or OFF. ON: Port-starboard and fore-aft speeds are synchronized. The ship's speed range setting window appears. Set speed appropriately. OFF: The ship's speed range setting window appears. Set fore-aft speed appropriately.
Graph	The speed range setting window shown depends on the setting of MODE in the DISP1 sub menu. TIDE or TIDE DIF: The tide speed range setting window appears. Set tide speed range (port-starboard of tide speed/tide differential graph) appropriately. SPEED: The ship's speed range setting window appears. Set ship's speed range (fore-aft of ship's speed graph) appropriately.
Course plot	The display scale setting window appears. Set display scale as appropriate.
Echo level	Tide speed range setting window appears. Set tide and tide differential range (radius of vector display ring) appropriately.

1. OPERATIONAL OVERVIEW

This page is intentionally left blank.

2. INTERPRETING THE DISPLAYS

2.1 Tide Vector Display

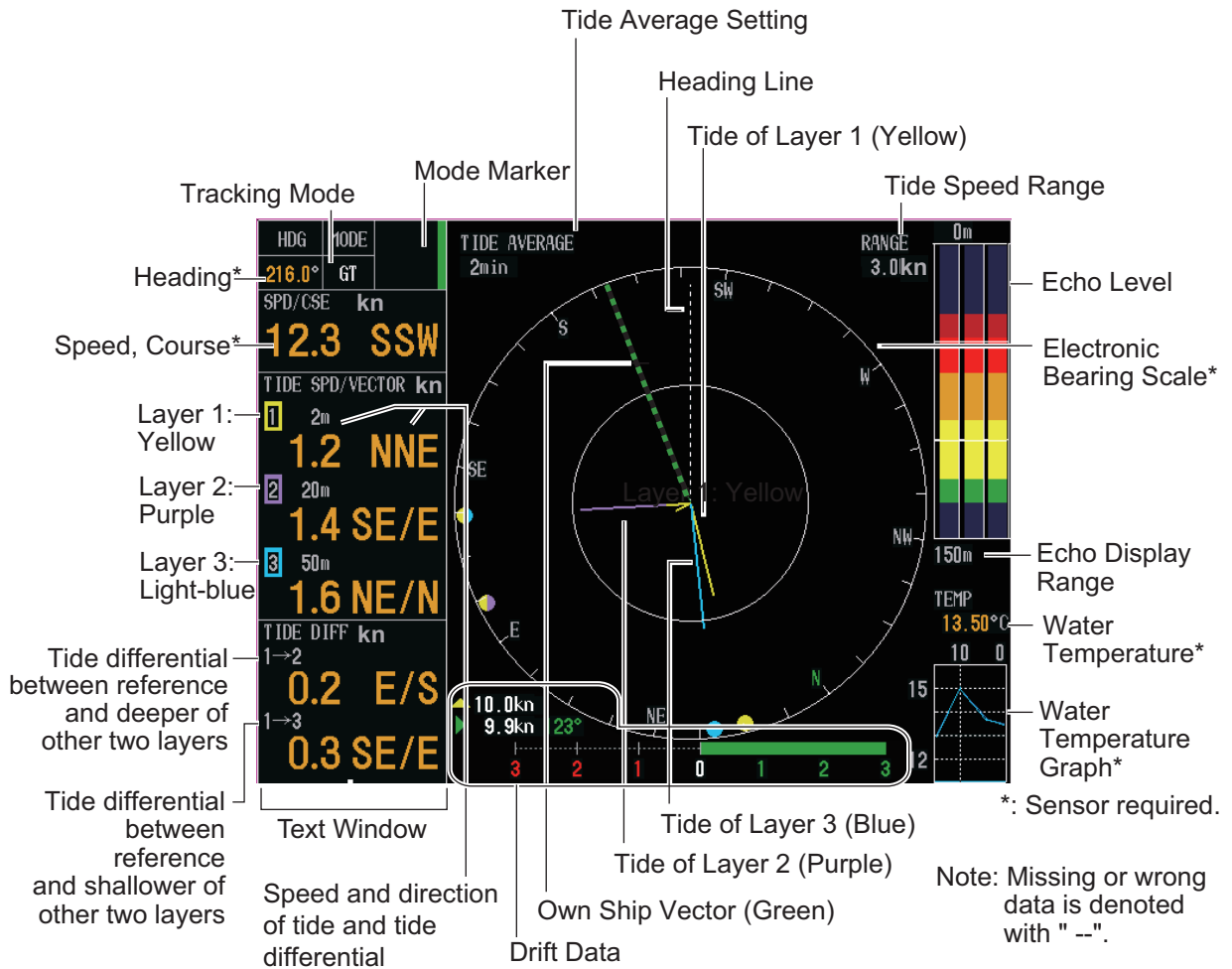

Tide vector display

2. INTERPRETING THE DISPLAYS

Description of indications on tide vector display

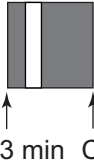
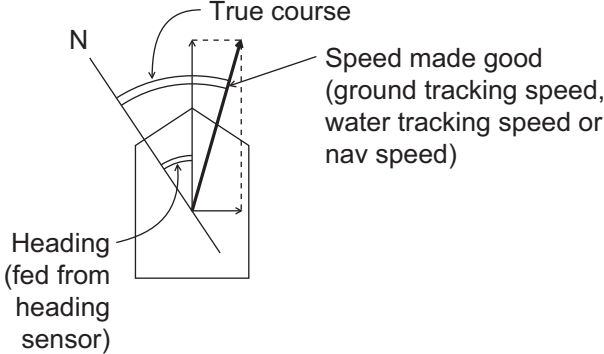
Item	Description
Heading	Ship's heading fed from a heading sensor.
Mode	Shows current tracking mode, as selected with the TRACK MODE key.
Mode marker	<p>Shows tracking mode and echo availability for last three minutes, scrolling from right to left. The color represents tracking mode as shown below.</p> <div style="display: flex; align-items: center; justify-content: center;">  <div style="margin-left: 10px;"> <p>Green: Ground tracking mode</p> <p>Blue: Water tracking mode, nav mode</p> <p>Background: Speed error</p> </div> </div>
Speed/course	<p>Speed made good and true course are shown. The displayable range is 0.0 to 40.0 kn for speed and 0° to 359° for course.</p> <div style="display: flex; align-items: center; justify-content: center;">  </div>

Item	Description
Tide speed and direction	<p>Tide speed and direction is shown for three layers (measuring depths). The displayable range is 0.0 to 9.9 kn for speed and 0° to 359° for course. Data shown depends on the measuring mode as follows:</p> <p>Ground tracking mode: Speed and direction values of measuring layers represent movement of layer relative to ground.</p> <p>Water tracking mode: Speed and direction values of measuring layers represent movement of layer relative to near-surface water.</p> <p>Nav mode: Speed and direction values represent movement of measuring layers relative to pseudo ground.</p> <p>The diagrams illustrate three measuring modes for tide speed and direction:</p> <ul style="list-style-type: none"> Ground Tracking Mode: Shows a ship's movement based on ground. Tide movements for Layer 1, Layer 2, and Layer 3 are shown relative to the bottom. A measuring depth is indicated. Direction (Dir) is shown as North (N). Speed values are shown for each layer. Water Tracking Mode: Shows a ship's movement relative to surface water. Tide movements for Layer 1, Layer 2, and Layer 3 are shown relative to surface water. The Surface Layer is designated as the Reference layer. Nav Mode: Shows a ship's movement measured by using satellites (Based on ground). Tide movements for Layer 1, Layer 2, and Layer 3 are shown relative to the ground. GPS Satellites are shown orbiting the ship.
Tide differential	<p>Tide speed and direction differential are shown between reference layer and shallower of the other two layers. The displayable range is 0.0 to 9.9 kn for speed and 0° to 359° for course. The reference layer may be selected with REF TIDE DIFF in the MENU 1 menu. For example, if the reference layer is layer 3, the tide differential between it and layer 1 and layer 2 will be displayed.</p>
Water temperature	<p>Water temperature is shown if a water temperature sensor is connected to the current indicator. The display range is -5 to 99 (°C).</p>
Water temperature graph	<p>Water temperature over the latest 15 minutes is displayed with a blue line, the data scrolling from right to left. The range of the temperature scale is 5°C and the range of the time scale is 15 minutes.</p>

2. INTERPRETING THE DISPLAYS

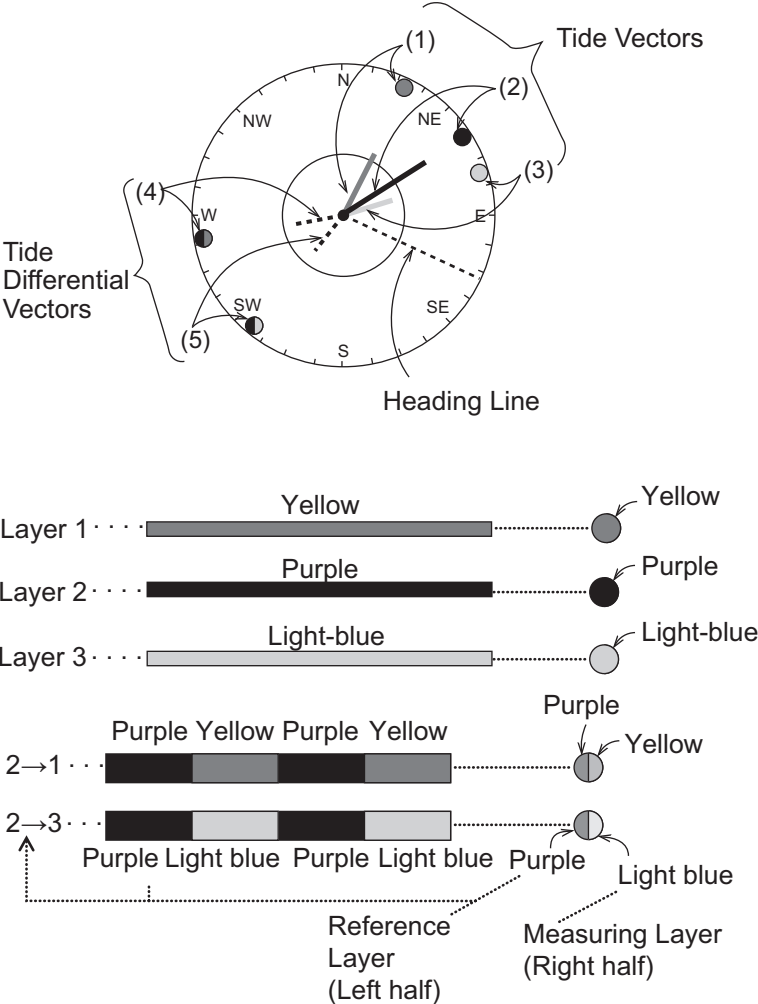
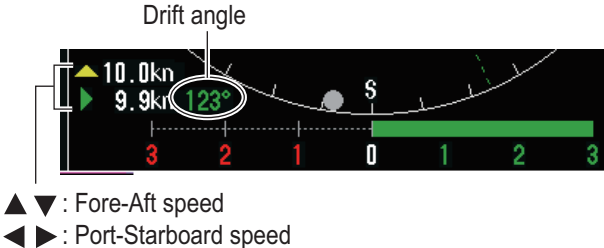
Item	Description
Heading line	The heading line is a dashed line which shows ship's heading. It extends from ship's position (center of vector display) to the edge of the vector display. The line can be turned on or off with HEADING LINE in the DISP1 menu.
Tide/tide differential vector	<p>Tide vectors may be turned on or off with LAYER 1, LAYER 2 and LAYER 3 in the DISP1 menu. The tide differential may be also be turned on or off with TIDE DIFF in the DISP1 menu. Note that if vectors overlap, the vector of the highest layer is shown.</p>  <p>The legend below the diagram shows the following configurations:</p> <ul style="list-style-type: none"> (1) Layer 1: Yellow (Reference Layer, Left half); Yellow (Measuring Layer, Right half) (2) Layer 2: Purple (Reference Layer, Left half); Purple (Measuring Layer, Right half) (3) Layer 3: Light-blue (Reference Layer, Left half); Light-blue (Measuring Layer, Right half) (4) 2→1: Purple Yellow Purple Yellow (Reference Layer, Left half); Yellow (Measuring Layer, Right half) (5) 2→3: Purple Light blue Purple Light blue (Reference Layer, Left half); Purple (Measuring Layer, Right half)
Ship's speed vector	The ship's speed vector may be shown on the vector display. This vector can be turned on or off with SHIP SPD VCTR in the DISP1 menu.
Drift data	<p>The drift angle and the fore-aft/port-starboard speed are shown. The port-starboard speed is also shown as a graph. The unit for the port-starboard speed graph is kn (knot). The maximum speed which the speed graph can show is 3 kn. Speeds over 3 kn are displayed as a full-graph bar, fixed at 3 kn.</p>  <p>▲▼ : Fore-Aft speed ◀▶ : Port-Starboard speed</p>

Item	Description
Electronic bearing scale	The electronic bearing scale shows bearing. If a heading sensor is connected the scale rotates with ship's movement.
Tide speed range	Tide speed range, as selected with TIDE RANGE in the DISP1 menu, appears at the top right-hand side on the screen.
Tide average setting	The value set with TIDE AVERAGE in the MENU 1 menu is shown.
Echo level	The echo level display shows echo level for the three sounding beams in colors or graph depending on the setting of DISP MODE in the DISP2 menu. You can turn the display on or off with ECHO LEVEL in the DISP2 menu.
Echo display range	The value set with ECHO RANGE in the MENU 1 menu is shown.

2.2 Ship's Speed Display

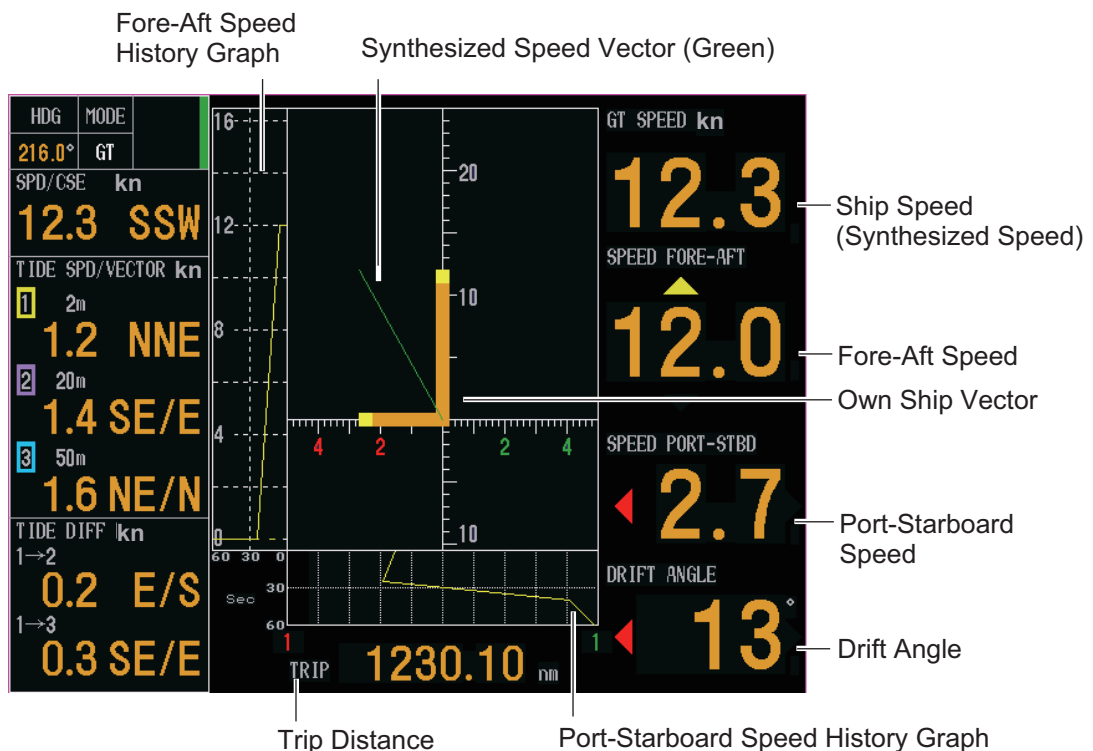

Ship's speed display

Description of ship's speed display indications

Item	Description									
Ship's speed* (In GT, WT) or Water tracking speed (In Nav mode)	Port-starboard and fore-aft speeds are synchronized when SCALE SYNC in the DISP2 menu is set to ON. The available speed setting range is 0.0 to 40.0 (kn). *: Speed measured depends on setting of SHIP SPD MODE in the DISP1 menu.									
	<table border="1"> <thead> <tr> <th></th> <th>Ground tracking mode</th> <th>Water tracking mode</th> </tr> </thead> <tbody> <tr> <td>Ref. layer selected</td> <td>Ship's speed</td> <td>Ship's speed</td> </tr> <tr> <td>Water tracking layer selected</td> <td>Ground tracking speed</td> <td>Water tracking speed</td> </tr> </tbody> </table>		Ground tracking mode	Water tracking mode	Ref. layer selected	Ship's speed	Ship's speed	Water tracking layer selected	Ground tracking speed	Water tracking speed
	Ground tracking mode	Water tracking mode								
Ref. layer selected	Ship's speed	Ship's speed								
Water tracking layer selected	Ground tracking speed	Water tracking speed								

2. INTERPRETING THE DISPLAYS

Item	Description
Fore-aft speed*	Speed in the fore-aft direction. The speed setting range is 0.0 to 40.0 (kn). Fore speed is denoted with a yellow "▲" above the speed readout and aft speed with a yellow "▼" below the speed readout.
Port-starboard speed*	Speed in the port-starboard direction. The speed setting range is 0.0 to 40.0 (kn). Port speed is denoted with a red "◀" to the left of the speed readout and starboard speed with a green "▶" to the right of the speed readout.
Drift angle*	The angle measured in degrees between ship's heading and the actual movement. When drift angle is to port, a red "◀" appears and when it is to starboard a green "▶" appears. In the NAV mode, drift in water tracking speed is shown.
Trip	Shows trip distance. The distance is referenced to fore or fore/aft depending on the setting of LOG PULSE OUT in the I/O menu.

Description of ship's speed display indications (con't from previous page)

Item	Description
Own ship vector*	The own ship vector shows port-starboard speed on the x-axis and fore-aft speed on the y-axis. The "synthesized speed vector" (green) appears when SCALE SYNC in the DISP2 menu is set to ON.
Fore-aft speed history graph	This graph shows fore-aft speed history over time, which is useful in trawling. HISTORY in the DISP2 menu sets the maximum range for the graph, and you can shift the range with HISTORY SHIFT in the DISP2 menu. The latest 60 minutes of fore-aft speed is shown, scrolling from right to left across the screen.
Port-starboard history graph	This graph shows port-starboard speed history over time, which is useful in trawling. DRIFT HISTORY in the DISP2 menu sets the maximum range for the graph. The latest 60 minutes of fore-aft speed is shown, scrolling from right to left across the screen.

*: Speed used for calculation depends on setting of SHIP SPD MODE in the DISP1 menu.

GT/WT: Speed is calculated according to tracking mode, ground speed for ground tracking mode and water speed for water tracking mode.

WT: Speed is calculated using water tracking speed regardless of speed tracking mode in use.

2.3 Graph Display

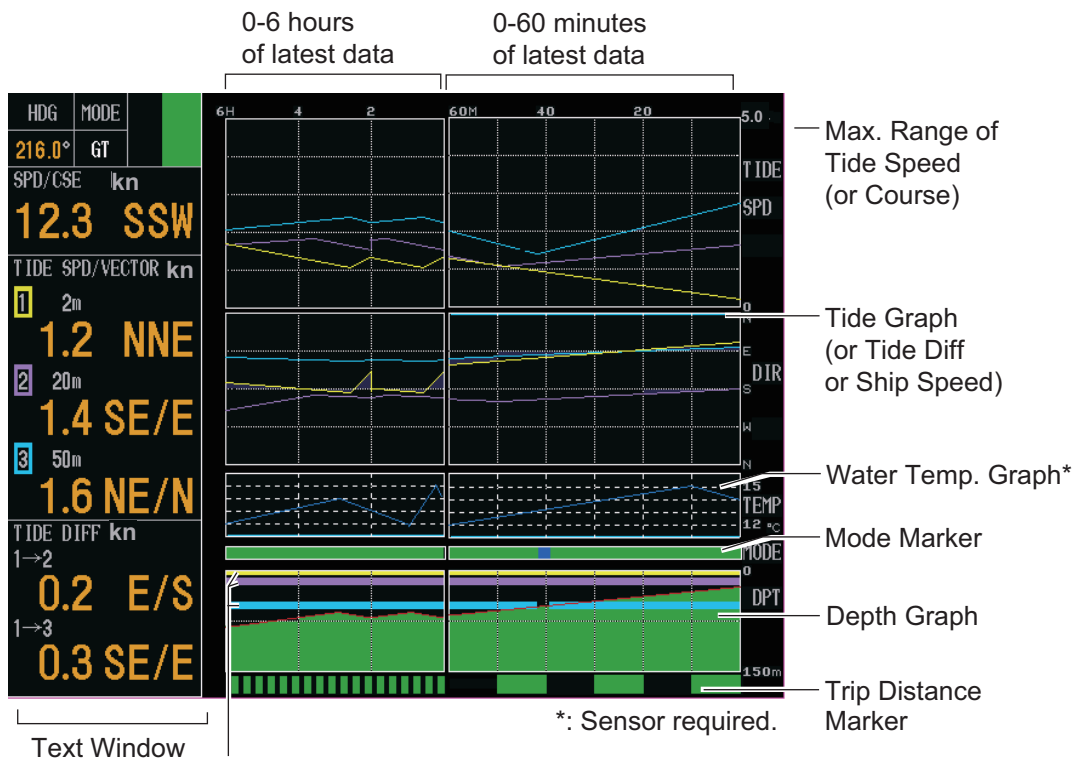

Depth of each layer

Note: When overlapping occurs, layer having highest number has priority.

Graph display

Description of graph display indications

Item	Description
Text window	The text window may be turned on or off with TEXT in the DISP1 menu. When the text window is turned off, 12 hours of graph data are shown.
Tide (or tide differential, speed) graph	You may choose the type of graph to display with MODE in the DISP1 menu. The maximum tide speed (or ship's speed) range may be chosen with TIDE RANGE in the DISP1 menu. Tide direction (or course) may be chosen with TIDE GRAPH in the DISP1 menu. For the tide graph, graph lines are displayed in colors: Layer 1, Yellow; Layer 2, Purple, and Layer 3, Blue. For the tide differential graph, the tide differential between layers 1 and 2 is shown in purple and that between layers 1 and 3 in light-blue.

2. INTERPRETING THE DISPLAYS

Description of graph display indications (con't from previous page)

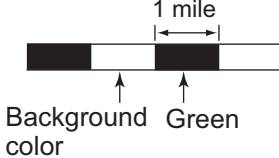
Item	Description
Water temperature graph	The water temperature graph may be turned on or off with TEMP GRAPH in the DISP1 menu.
Mode marker	The mode marker shows by color which tracking mode is in use. Green: Ground tracking mode Blue: Water tracking mode, nav mode Background: Ship's peed error
Depth graph	The depth graph displays depth data in graph form. If, in the water tracking mode, the depth is greater than the depth range no depth data is displayed. To graph depth from an external source, set DEPTH SOURCE in the OTHER menu (sub menu in the installation menu) to EXTERNAL.
Trip distance marker	<p>The trip distance marker shows trip distance in one-mile increments, in green and background color alternately as shown below.</p> 

2.4 Course Plot Display

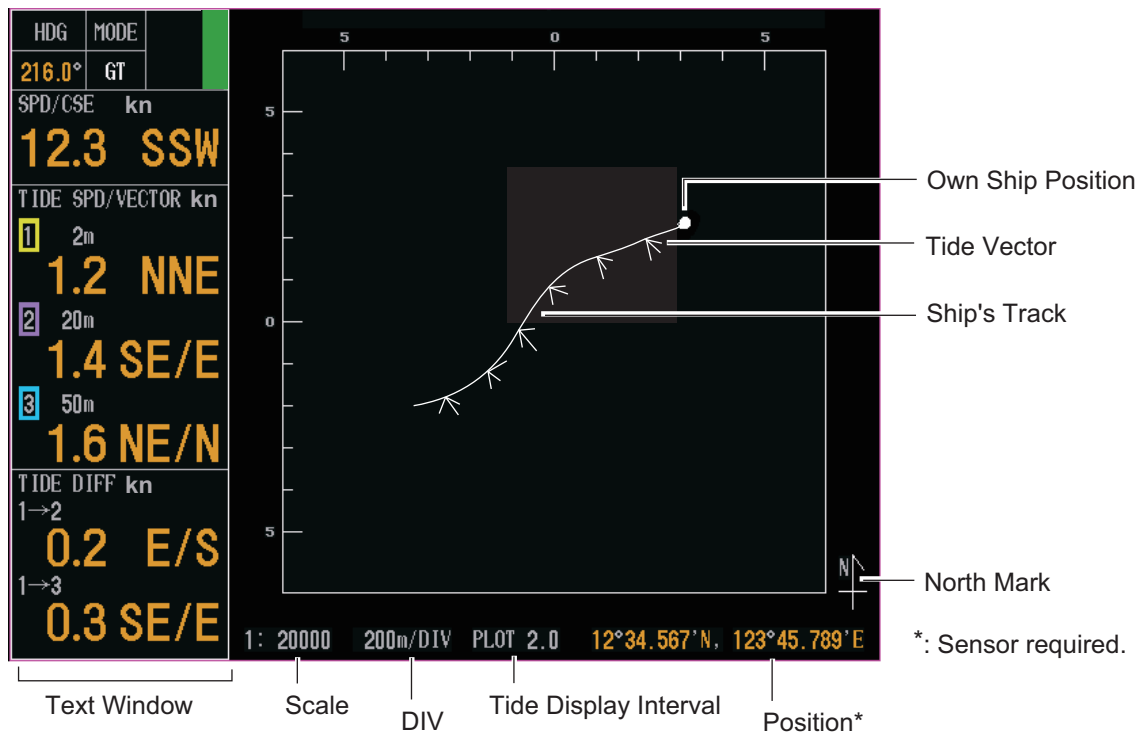

Course plot display

Description of course plot display indications

Item	Description
Text window	The text window can be turned on or off with TEXT WINDOW in the DISP2 menu. With the text window turned off, the amount of track displayed is greater.
Ship's track	Ship's track is drawn with a white solid line. Ship's track starts extending from the screen center and when own ship position reaches the edge of the screen it is brought back to the screen center. You may turn the ship's track line on or off with SHIP TRACK in the DISP2 menu.
Tide vector	The length of the tide vectors may be chosen with VECTOR LENGTH in the DISP2 menu. Vectors may be turned on or off with LAYER 1 - LAYER 3 in the DISP1 menu.
North mark	The north mark points upward on the course plot display.
Scale	You may choose the scale with SCALE in the DISP2 menu.
DIV	Shows range per scale division.
Tide display interval	You may choose the tide display interval with INTERVAL in the DISP2 menu. In the illustration above the interval is "2".
Position	Position is shown in latitude and longitude.

2.5 Numeric Display

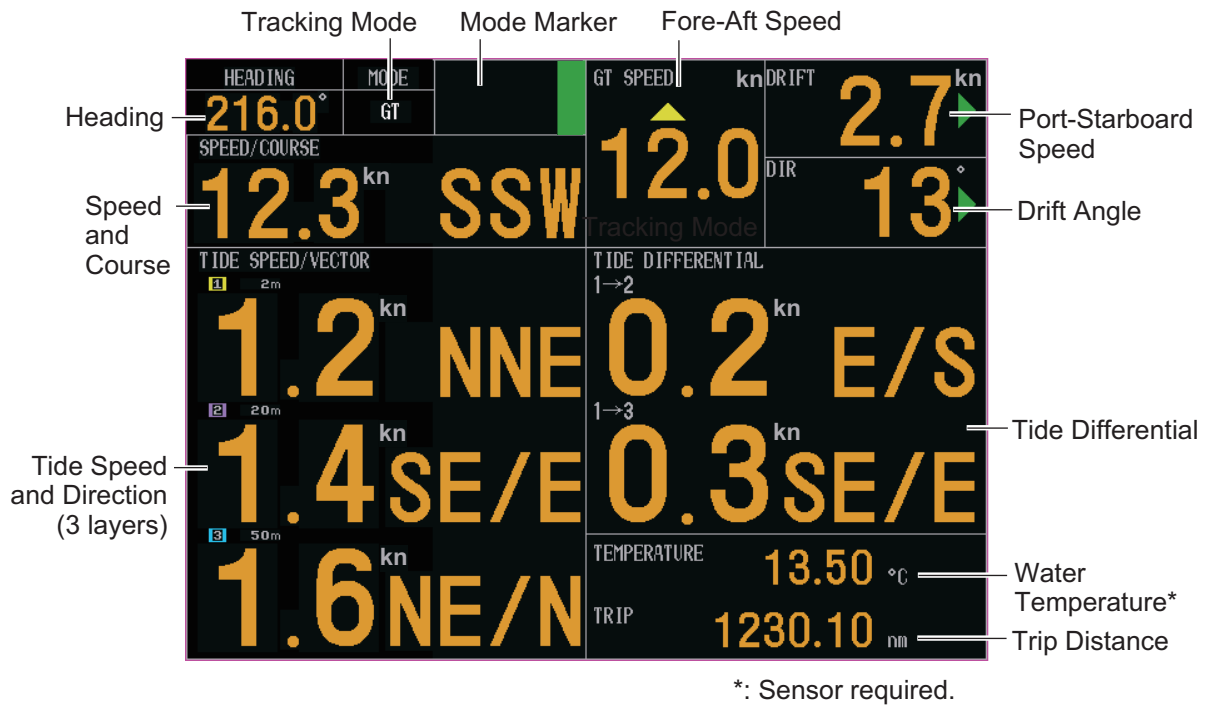

The table below explains only the item which is different from the Tide Vector and Ship's Speed displays. Refer to "Tide Vector Display" and "Ship's Speed Display" for other items.

Item	Description
Mode Marker	Displays the reception status for the past seven and half minutes only on the numeric display.

2.6 Echo Level Display

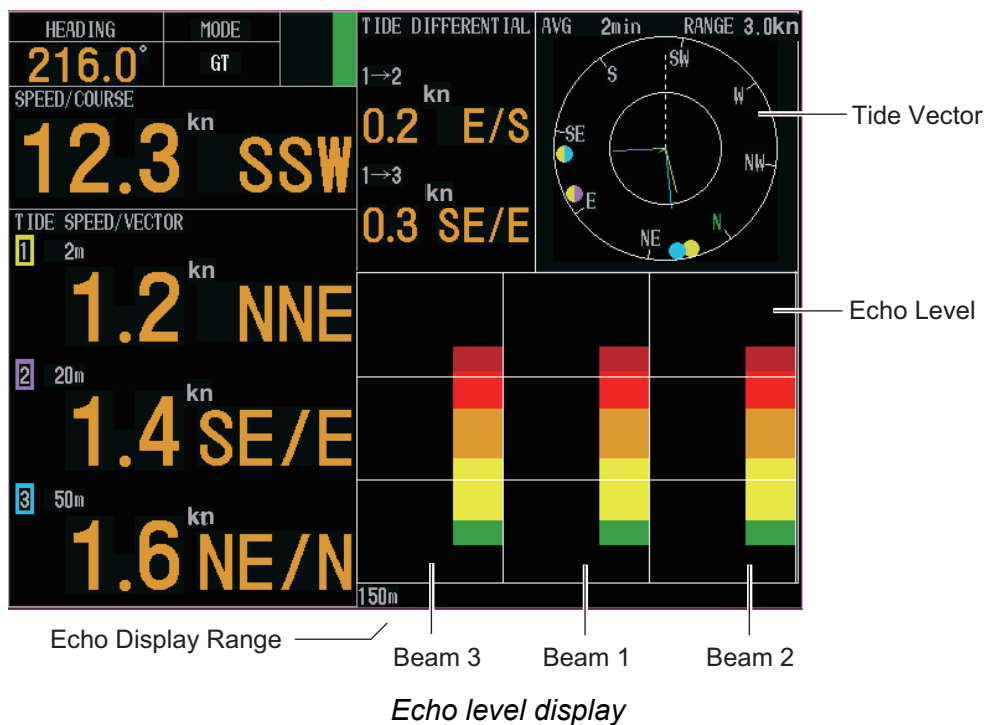

Description of echo level display indications

Item	Description
Echo level	Echo status of beam 1 (fore), beam 2 (starboard) and beam 3 (port) is displayed in eight colors.
Echo display range	The echo display range can be set with ECHO RANGE in the MENU 1 menu.

2.7 Error Display

An error icon (red square) appears whenever display data or measured data is abnormal. When this occurs the corresponding data will be unreliable.

Speed and course (fore-aft, port-starboard, drift angle)

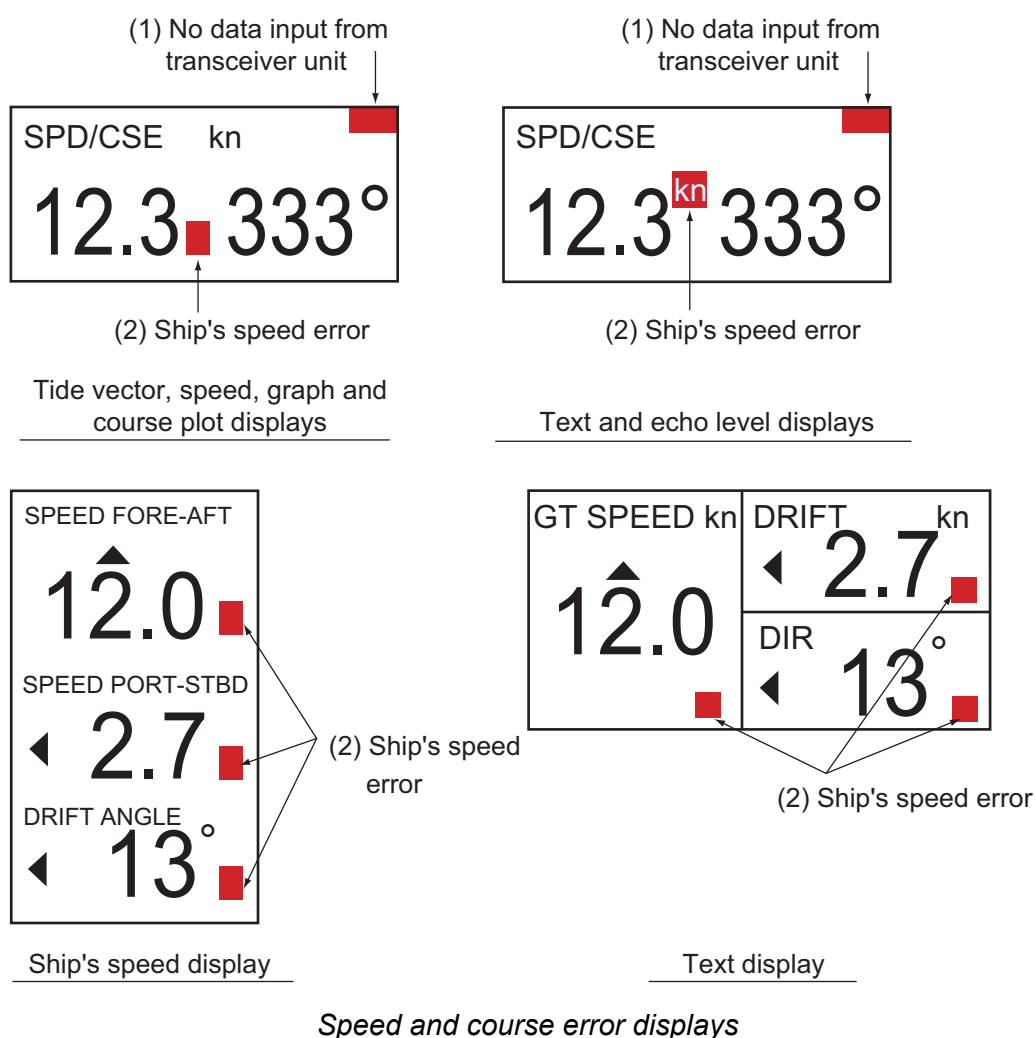

- (1) No data is being input from the transceiver unit to the display unit. If this occurs, contact a FURUNO agent or dealer.
- (2) This display appears when the ground tracking echo for ground tracking, reference layer for water tracking or GPS data from the GPS navigator is abnormal. In this case data is not reliable.

2. INTERPRETING THE DISPLAYS

Tide for three layers/tide differential

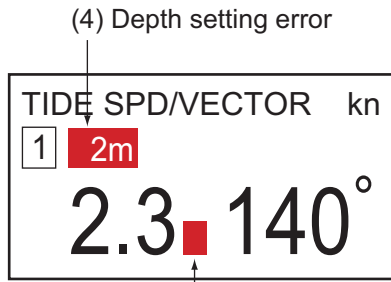

(3) Echo from measuring layer is abnormal

Tide vector, speed, graph and course plot displays

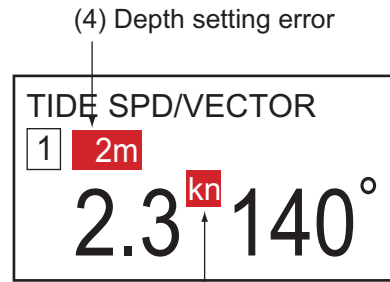

(3) Echo from measuring layer is abnormal

Text and echo level displays

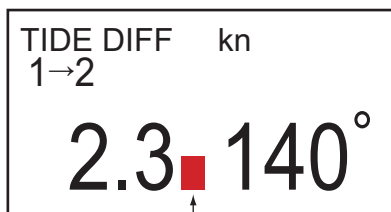

3) Echo from measuring layer is abnormal

Tide vector, speed, graph and course plot displays

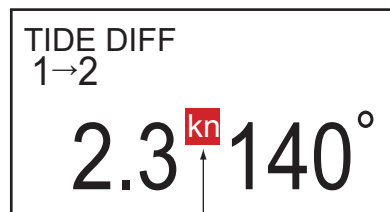

3) Echo from measuring layer is abnormal

Text and echo level displays

Tide and tide differential error displays

- (3) Displayed when echo for a measuring layer is abnormal. The readout for the offending measuring layer is not reliable.
- (4) Displayed when the depth setting for a measuring layer is improper. The readout for the offending measuring layer is not reliable.

Improper depth setting conditions

- Depth in ground tracking mode is less than 10 m.
- Depth setting is more than 75% of actual depth.
- Echo cannot be obtained because of air bubbles, etc.
- Echo for set depth cannot be found because depth has become deeper than set depth.

3. CUSTOMIZING THE SYSTEM

Less-often used functions are stored in the menu. There are four main menus, MENU 1, MENU 2, ALARM and INSTALLATION. The MENU 2 and INSTALLATION menus have three sub menus each.

3.1 Menu Operation

1. Press the **MENU** key to open the menu. The last-used menu appears.

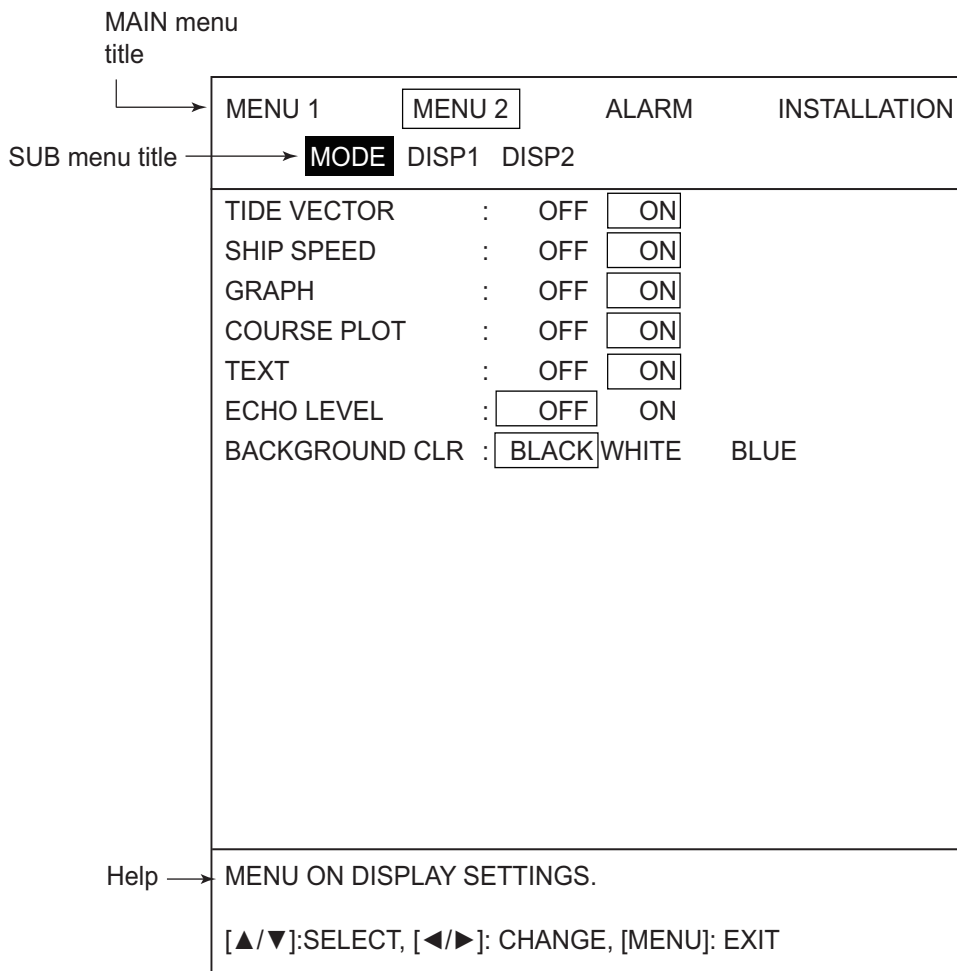

MODE menu

2. Press **▲** to place the cursor on the main menu title field.

3. CUSTOMIZING THE SYSTEM

3. Press ◀ or ▶ to choose the main menu desired among MENU 1, MENU 2, ALARM and INSTALLATION menus. Then, the menu changes according to your selection. For the MENU 2 and INSTALLATION menus the sub menu title appears. To choose a sub menu, press ▼ to choose the sub menu title field and then press ◀ or ▶ to choose the sub menu desired.

Note: The INSTALLATION menu is locked to prevent unintentional adjustment of its settings. When you move the cursor from ALARM to INSTALLATION, the following message appears. To open the INSTALLATION menu, press any function key.

PRESS ANY FUNC KEY TO OPEN INSTALLATION MENU.
PRESS [MENU] KEY TO OPEN ALARM MENU.

4. Press ▲ or ▼ to choose menu item desired. Selected item is displayed in reverse video and menu help appears in the box at the bottom of the menu.
5. Press ◀ or ▶ to choose menu option or change numerical value. To change numerical value, press ▶ to raise the value; ◀ to lower the value.
6. Press the **MENU** key to close the menu.

3.2 Function Keys

3.2.1 Programming the function keys

The function keys ([F1]-[F3]) provide menu shortcut operation. You may program the keys as follows:

1. Press the **MENU** key to display the main menu.
2. Choose menu desired.
Note: The ALARM and INSTALLATION menus cannot be used.
3. Choose menu item desired.
Note: RESET TRIP LOG, TEST and BOTTOM SEARCH in the MENU 1 cannot be used.
4. Press and hold down a function key until you hear three beeps and the message "PROGRAMMED SELECTED ITEM TO [F*] KEY" is displayed (about five seconds). (* Function key number pressed.)
5. Press the **MENU** key to close the menu.

3.2.2 Using the function keys

The function keys provide shortcut menu operation, and they are not programmed at the factory. If a function key contains no program when pressed, the message "NO FUNCTION ASSIGNED TO [F*] KEY" appears on the display for about five seconds. (* function key pressed.)

1. Press any function key. An appropriate setting window appears on the display.
2. Within five seconds after completing step 1, operate the CursorPad to change setting as below.
Change numeric data: ► or ▲ to raise the setting; ◀ or ▼ to lower it.
Choose option: ► or ▲ to scroll rightward; ◀ or ▼ to scroll leftward.

3.3 MENU 1 Menu

This menu mainly provides items for adjustment of tide parameters.

MENU 1	MENU 2	ALARM	INSTALLATION
SHIP SPEED AVG :	<input type="text" value="15 sec"/>	30 sec	60 sec 90 sec
TIDE AVERAGE :	<input type="text" value="2 min"/>		
REF TIDE DIFF :	<input type="text" value="LAYER 1"/>	LAYER 2	LAYER 3
BEARING MODE :	<input type="text" value="32 CMPS"/>	360	TRUE
NAV MODE :	<input type="text" value="OFF"/>		ON
BOTTOM SEARCH:	<input type="text" value="NO"/>		YES
BTM TIDE TRACK :	<input type="text" value="OFF"/>		ON
ALM/KEY BEEP :	OFF	<input type="text" value="ON"/>	
WT SPD DEPTH :	<input type="text" value="2 m"/>	(2-400m)	
RESET TRIP LOG :	<input type="text" value="NO"/>		YES
TEST :	<input type="text" value="NO"/>	GENERAL	PANEL PATTERN
ECHO RANGE :	<input type="text" value="150 m"/>		
TVG :	<input type="text" value="OFF"/>		ON
GAIN :	<input type="text" value="5"/>	(1-40)	
PANEL DIMMER :	<input type="text" value="5"/>	(0-7)	
MENU ON INITIAL SETTINGS.			
[▲/▼]:SELECT, [◀/▶]: CHANGE, [MENU]: EXIT			

MENU 1 menu

SHIP SPEED AVG

Choose the averaging time for the ship's speed display. The choices are 15, 30, 60 and 90 seconds.

TIDE AVERAGE

Choose the averaging time for the tide display. If tide speed appears to be too slow, choose a higher setting. The choices are 15 sec, and 1, 2, 3, 5, 10 and 20 minutes.

REF TIDE DIFF

Choose the reference layer for tide differential measurements, among layer 1, layer 2 and layer 3.

BEARING MODE

You may show bearing in 32 compass points or 360 degrees.

NAV MODE

NAV MODE enables or disables the NAV mode. Choose ON to use NAV mode instead of the water tracking mode. For further details, see paragraph 1.6.

BOTTOM SEARCH

BOTTOM SEARCH enables reacquisition of temporarily lost ground echo, in the water tracking mode. When the bottom echo is lost for a short while due to air bubbles, or the equipment tends to track on false bottom, acquire the bottom echo manually as follows:

1. Set BOTTOM SEARCH to YES and close the menu. The rectangle cursor appears on the display.
2. Press any function key.
3. Use ▲ or ▼ to set the cursor on the bottom echo.

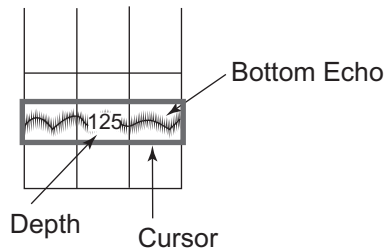
*How to acquire bottom echo*

4. Press the **MENU** key to finish and close the menu.

BTM TIDE TRACK

Choose how to track bottom tide, in the ground tracking mode.

- ON: Measuring depth of layer 3 changes automatically with the bottom depth to track on near-bottom tide. In this case the layer 3 indications shows "BTM" instead of the tide measurement depth.
- OFF: Normal selection of measuring depth for layer 3.

ALM/KEY BEEP

A key beeps to confirm correct key input, input error or error message. You may turn this beep on or off as desired. The beep sounds when an alarm setting is violated regardless of whether this item is turned on or off.

WT SPD DEPTH

Set the reference depth at which to measure ship's speed in the water tracking mode. Set the depth for which you want to know the water tracking speed in reference to a specific depth. The setting range is 2-250 (m).

RESET TRIP LOG

Set the trip distance to zero (0). Choose YES and then you are prompted "PRESS ANY FUNCTION KEY TO EXECUTE" Press any function key to reset the trip log to zero.

TEST

Choose the diagnostic test to execute: General (program no. display, memory check, etc.), panel or pattern. For further details, see paragraph 4.4.

ECHO RANGE

Choose the maximum depth to display echoes, from among 50, 100, 150, 200, 250, 300, 350, 400, 450, 500 (m).

3. CUSTOMIZING THE SYSTEM

TVG

Turn echo TVG on or off.

GAIN

Adjust echo level display color. The higher the digit the nearer to the strongest color (reddish brown). "GAIN" does not adjust the gain of the received signal; speed and tide values are not affected by this adjustment. The setting range is 1-40.

PANEL DIMMER

Adjust the backlighting for the control panel, from 0-7.

3.4 MENU 2 Menu

3.4.1 MODE menu

This menu mainly turns displays on or off. All displays cannot be turned off; at least one must be turned on. Any display turned off on the MODE menu is removed from selection with the **DISP MODE** key.

MENU 1	MENU 2	ALARM	INSTALLATION
MODE	DISP1	DISP2	
TIDE VECTOR	: OFF	<input type="checkbox"/> ON	
SHIP SPEED	: OFF	<input type="checkbox"/> ON	
GRAPH	: OFF	<input type="checkbox"/> ON	
COURSE PLOT	: OFF	<input type="checkbox"/> ON	
TEXT	: OFF	<input type="checkbox"/> ON	
ECHO LEVEL	: <input type="checkbox"/> OFF	ON	
BACKGROUND CLR	: <input type="checkbox"/> BLACK	<input type="checkbox"/> WHITE	<input type="checkbox"/> BLUE
MENU ON DISPLAY SETTINGS.			
[▲/▼]:SELECT, [◀/▶]: CHANGE, [MENU]: EXIT			

DISP menu

TIDE VECTOR

Enable or disable the tide vector display.

SHIP SPEED

Enable or disable the ship's speed display.

GRAPH

Enable or disable the tide graph display.

COURSE PLOT

Enable or disable the course plot display.

TEXT

Enable or disable the text display.

ECHO LEVEL

Enable or disable the echo level display.

BACKGROUND CLR

Choose the background color from among black, white and dark blue.

3.4.2 DISP1 menu

MENU 1	MENU 2	ALARM	INSTALLATION
MODE	DISP1	DISP2	
COMMON SETTINGS			
TIDE RANGE	: <input type="text" value="3.0kn"/>		
SHIP SPD VCTR	: <input type="text" value="OFF"/>		ON
HEADING LINE	: OFF		<input type="text" value="ON"/>
TIDE VECTOR			
LAYER 1	: OFF		<input type="text" value="ON"/>
LAYER 2	: OFF		<input type="text" value="ON"/>
LAYER 3	: OFF		<input type="text" value="ON"/>
TIDE DIFF	: OFF		<input type="text" value="ON"/>
DISPLAY MODE	: <input type="text" value="HEAD UP"/>		NORTH UP
SHIP SPD MODE	: <input type="text" value="GT/WT"/>		WT
GRAPH			
MODE	: <input type="text" value="TIDE"/>	TIDE DIF	SHIP SPD
TIDE GRAPH	: <input type="text" value="NORTH"/>		SOUTH
TEMP GRAPH	: OFF		<input type="text" value="ON"/>
TEXT WINDOW	: OFF		<input type="text" value="ON"/>
MENU ON DISPLAY SETTINGS.			
[▲/▼]:SELECT, [◀/▶]: CHANGE, [MENU]: EXIT			

Graph display settings

DISP1 menu

TIDE RANGE

Set the tide range for the tide vector display, graph display and echo level display. The choices are 0.5, 1.0, 1.5, 2.0, 3.0, 5.0 and 10.0 (kn).

SHIP SPD VCTR

Turn the ship's speed vector on or off on the tide vector display and echo level display.

HEADING LINE

Turn the heading line on or off on the tide vector display and echo level display.

3. CUSTOMIZING THE SYSTEM

LAYER 1, LAYER 2, LAYER 3, TIDE DIFF

Turn the tide vector on or off for the respective item on the tide vector display and echo level display.

DISPLAY MODE

Set display orientation for head-up or north-up. Heading device required for North-up.

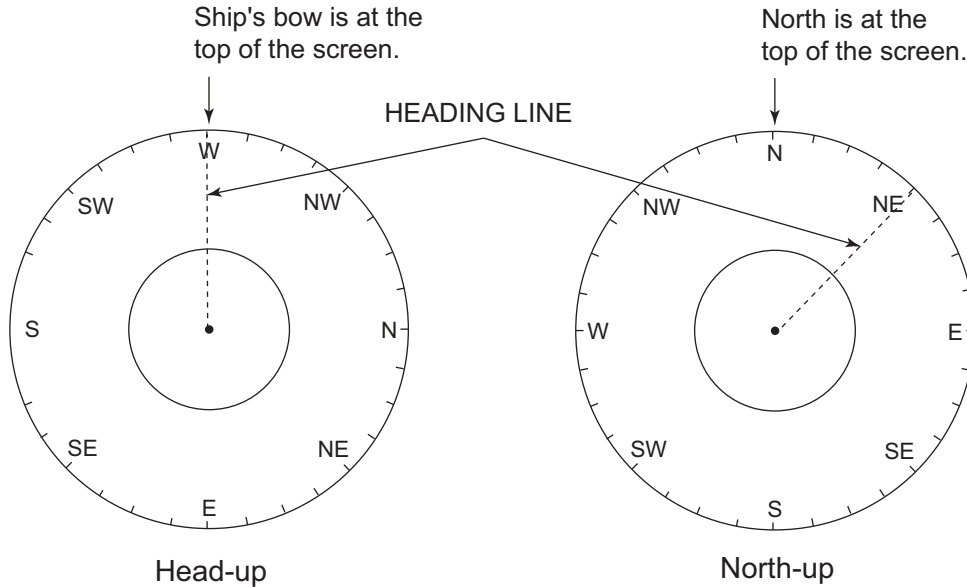

Head-up and north-up display modes

SHIP SPD MODE

Choose the speed source to use to display drift angle, fore-aft speed and port-starboard speed on the ship's speed and text displays.

MODE

Choose the item to show on the graph display, among tide, tide differential and ship's speed.

TIDE GRAPH

Choose how to draw the tide on the graph display. The choices are NORTH (N, E, S, W) and SOUTH (S, W, N, E). Normally, use NORTH. When the graph becomes difficult to read switch to SOUTH.

TEMP GRAPH

Turn the water temperature graph on the graph display on or off.

TEXT WINDOW

Turn the text window on the graph display on or off.

3.4.3 DISP2 menu

	MENU 1	MENU 2	ALARM	INSTALLATION
	MODE	DISP1	DISP2	
Tide vector display settings	TIDE VECTOR			
	ECHO LEVEL	: OFF	<input type="checkbox"/> OFF	<input type="checkbox"/> ON
	DISP MODE	: <input type="checkbox"/> SOUNDER	<input type="checkbox"/> GRAPH	
Ship's speed display settings	SHIP SPEED			
	SCALE SYNC	: OFF	<input type="checkbox"/> OFF	<input type="checkbox"/> ON
	DRIFT SCALE	: <input type="text" value="1.0 kn"/>		
	SCALE	: <input type="text" value="10.0 kn"/>		
	DRIFT HISTORY	: 0.5 kn	<input type="checkbox"/> 1 kn	<input type="checkbox"/> 2 kn
	HISTORY	: 4 kn	<input type="checkbox"/> 8 kn	<input type="checkbox"/> 16 kn
	HISTORY SHIFT	: <input type="text" value="0 kn"/>		<input type="checkbox"/> 32 kn
Tide differential display settings	COURSE PLOT			
	SCALE	: 1:10000	<input type="checkbox"/> 1:20000	<input type="checkbox"/> 1:50000
	INTERVAL	: <input type="text" value="2.0"/>		<input type="checkbox"/> 1:100000
	SHIP TRACK	: OFF	<input type="checkbox"/> OFF	<input type="checkbox"/> ON
	VECTOR LENGTH	: <input type="checkbox"/> LONG	<input type="checkbox"/> SHORT	
	TEXT WINDOW	: OFF	<input type="checkbox"/> OFF	<input type="checkbox"/> ON
MENU ON DISPLAY SETTINGS.				
[▲/▼]:SELECT, [◀/▶]: CHANGE, [MENU]: QUIT				

DISP2 menu

ECHO LEVEL

Turn the echo level display on or off on the tide vector display.

DISP MODE

Choose how to show the echo level display.

SOUNDER: Echo strength shown in eight colors.

GRAPH: Echo strength shown by graph.

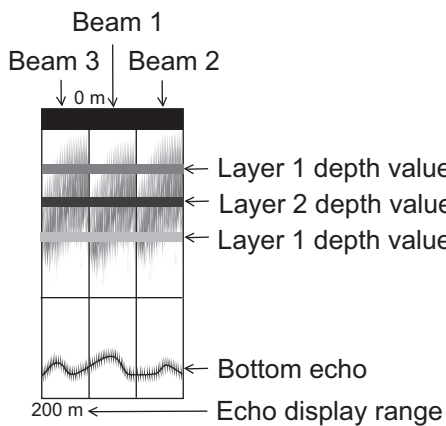

COLOR GRADATION
(Color sounder)

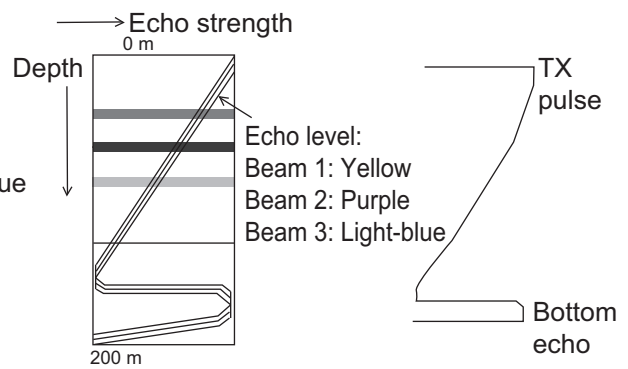

AMPLITUDE GRAPH
(A-scope)

Echo level displays

3. CUSTOMIZING THE SYSTEM

SCALE SYNC

Choose whether to interlock port-starboard speed range with fore-aft speed range or not.

DRIFT SCALE

Set the port-starboard speed range on the ship's speed display. The choices are 0.5, 1.0, 1.5, 2.0, 3.0, 5.0 and 10.0 (kn).

Note: You may adjust DRIFT SCALE at any time, however you must turn off SCALE SYNC in the DISP2 menu for it to become active.

SCALE

Set the range of fore-aft speed and on the ship's speed display. The choices are 0.5, 1.0, 2.0, 3.0, 5.0, 10.0, 20.0 and 30.0 (kn). Port-starboard speed range is also set.

Note: You may adjust SCALE at any time, however you must turn on SCALE SYNC in the DISP2 menu for it to become active.

DRIFT HISTORY

Set the range for the port-starboard speed history graph. The choices are 0.5, 1 and 2 (kn).

HISTORY

Set the range for the fore-aft speed history graph. The choices are 4, 8, 16 and 32 (kn).

HISTORY SHIFT

Set the amount of shift for the fore-aft speed history graph among -2, -1, 0, 1, 2, 4 and 8 (kn).

SCALE

Choose the scale to use in the course plot display, from among 1:10000, 1:20000, 1:50000 and 1:100000.

INTERVAL

Choose the display interval for the tide vector in the course plot display. The choices are 0.5, 1.0, 1.5, 2.0, 2.5, 3.0, 3.5 and 4.0 (minute).

SHIP TRACK

Turn own ship's track display on or off.

VECTOR LENGTH

Choose the vector length from LONG or SHORT. For LONG 1 mm in length is equal to 0.1 knot.

TEXT WINDOW

Turn the text window on the course plot display on or off.

3.5 ALARM Menu

The ALARM menu sets the parameters for the tide speed and tide direction alarms, ship's speed alarm and trip distance alarm. When an alarm setting is violated, the audible alarm sounds and a warning message (flashing) appears. To silence the audible alarm, press the CursorPad. The alarm message remains on the screen until the cause for the corresponding alarm is eliminated or the alarm is disabled. When the alarm is again violated, the alarm message appears and the audible alarm is released.

The audible alarm and alarm message may be enabled or disabled independently. Alarm messages appear in paragraph 4.5.

Note: Alarm priority is in the order the alarms appear on the ALARM menu; highest priority is layer 1 and lowest priority is the trip alarm. When multiple alarms are violated, the audible and visual alarms are given to the alarm having the highest priority.

3.5.1 Alarm types

LAYER 1, LAYER 2, LAYER 3

Tide speed and direction alarms for respective tide layers.

SHALLOW T/D, DEEP T/D

SHALLOW T/D: Sets the tide difference between the base layer and the shallower of the other two layers.

DEEP T/D: Sets the tide difference between the base layer and the deeper of the other two layers.

Reference Layer	Shallow TD	Deep TD
1	1→2	1→3
2	2→1	2→3
3	3→1	3→2

SHIP SPEED

Sets speed and course for speed alarm.

TRIP

Sets distance and time for trip alarm.

3.5.2 Setting/Canceling tide speed, tide direction, tide differential and ship's speed alarms

This section shows how to set the tide speed, tide direction, tide differential and ship speed alarms. As an example, for LAYER 1, set the tide speed alarm for 1-2 kn and tide direction alarm for 350°-10°.

Setting tide speed, tide direction, tide differential and ship's speed alarms

1. Press the **MENU** key to open the menu.
2. Press **▲** to place the cursor on the main menu title field.
3. Press **◀** or **▶** to choose ALARM.

MENU 1	MENU 2	ALARM	INSTALLATION
LAYER 1	: SPD		
	: DIR		
LAYER 2	: SPD		
	: DIR		
LAYER 3	: SPD		
	: DIR		
SHALLOW T/D	: SPD		
	: DIR		
DEEP T/D	: SPD		
	: DIR		
SHIP SPEED	: SPD		
	: CSE		
TRIP	: DIST		
	: TIME		
MENU ON ALARM SETTINGS.			
[▲/▼]:SELECT, [◀/▶]: CHANGE, [MENU]: EXIT			

ALARM menu

Alarm status is shown with the speaker icons.

): Alarm ON (Audible alarm and alarm message: ON)

 : Alarm OFF (Audible alarm: OFF, Alarm message: ON)

4. Use **▲** or **▼** to choose LAYER1-SPD.

- Press ► to open the alarm setting window.

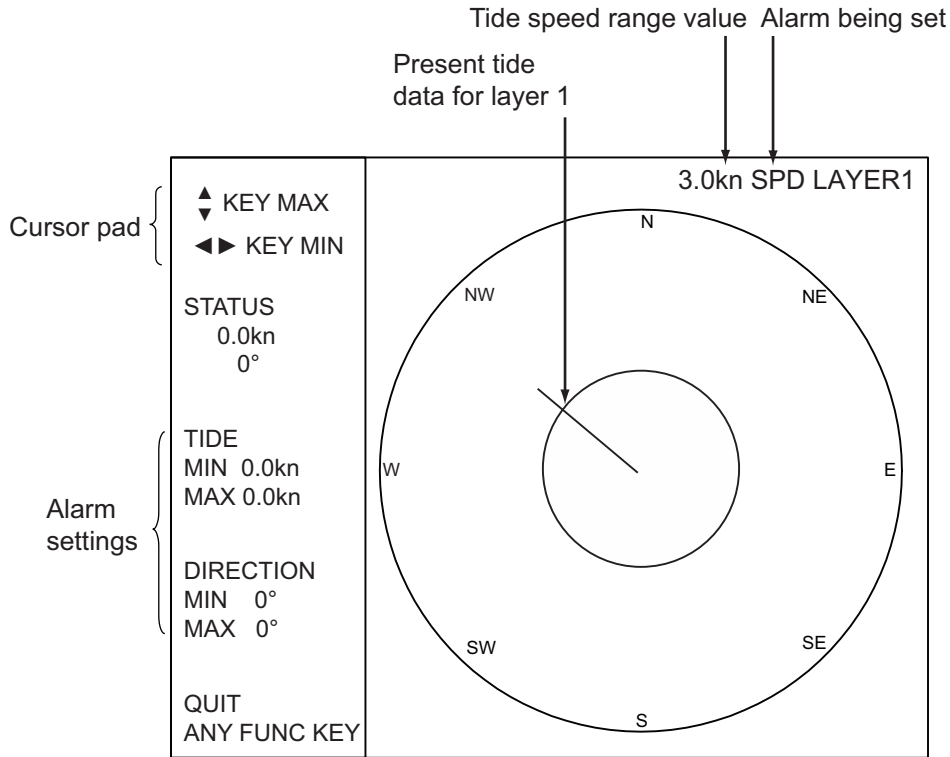

Alarm setting screen (tide, ship's speed)

- Use ◀ or ▶ to set minimum speed; ▲ or ▼ to set maximum speed. As you operate an "arrow," the radius of the inner or outer circle is increased or decreased accordingly. Your screen should now look something like the one shown below.

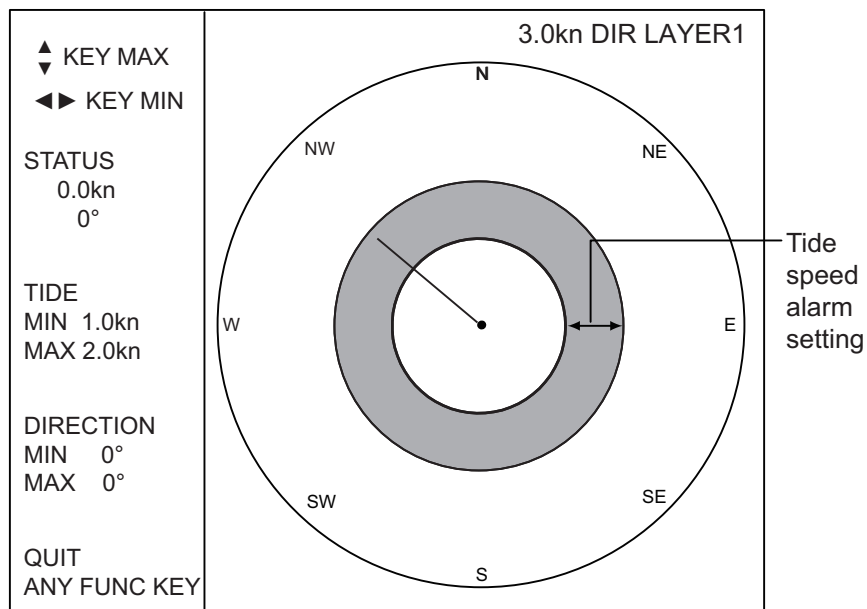

Alarm setting screen (tide speed set)

- Press any function key to return to the ALARM menu. □) appears to the right of SPD.
- Press ▼ to choose DIR at LAYER 1.
- Press ► to open the setting window.

3. CUSTOMIZING THE SYSTEM

- Use ◀ or ▶ to set starting point; ▲ or ▼ to set ending point. For example, set the starting point at 350° and the ending point at 10°. Then, the screen should look something like the one at the top of the next page.

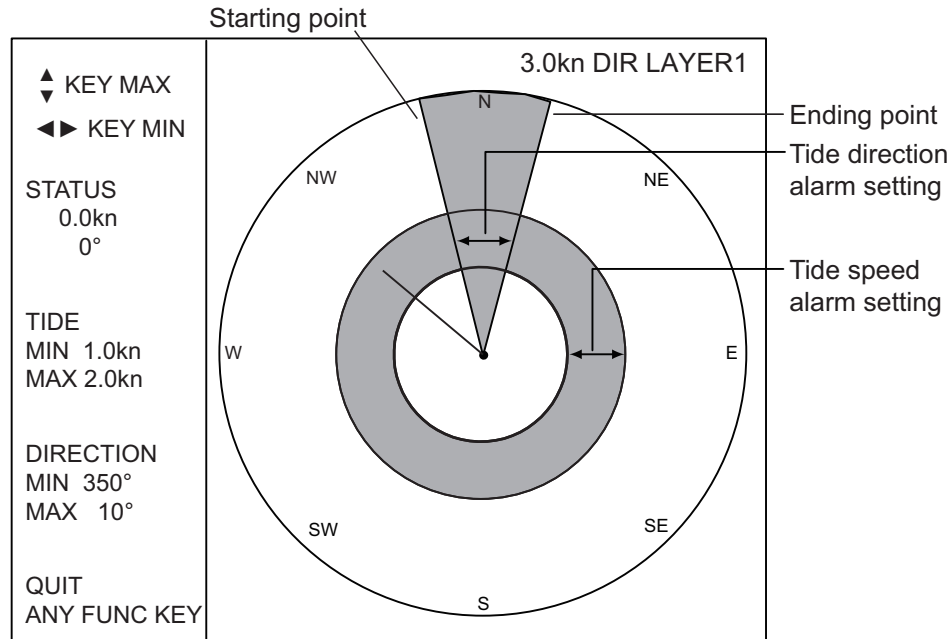

Alarm setting screen (tide)

- Press any function key to return to the ALARM menu. “)” appears to the right of DIR in LAYER 1. When the alarm setting is violated, the audible alarm sounds and an alarm message appears.
- Press the **MENU** key to close the menu.

3.5.3 Setting the trip alarm

Trip distance alarm

The trip distance alarm sounds when the vessel has traveled more than the preset distance.

- Press the **MENU** key to open the menu.
- Press ▲ to place the cursor on the main menu title field.
- Press ◀ or ▶ to choose ALARM.
- Press ▲ or ▼ to choose TRIP-DIST.
- Press ▶ to show the trip distance setting screen.



- Press ◀ or ▶ to set distance.
- Press any function key to quit and return to the ALARM menu. “)” appears to the right of TRIP-DIST. When the vessel has traveled more than the preset distance, the audible alarm sounds and an alarm message appears.
- Press the **MENU** key to close the menu.

Trip time alarm

The trip alarm sounds when the preset trip time has elapsed.

1. Press the **MENU** key to open the menu.
2. Press **▲** to place the cursor on the main menu title field.
3. Press **◀** or **▶** to choose ALARM.
4. Press **▲** or **▼** to choose TRIP-TIME.
5. Press **▶** to show the trip time alarm setting screen.

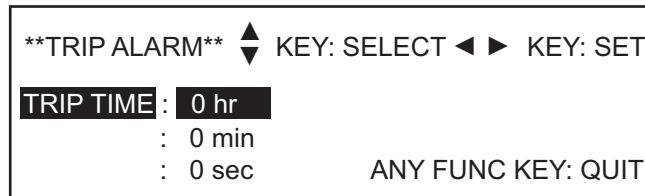

Time trip alarm setting screen

6. Press **▲** or **▼** to choose item to set.
7. Press **◀** or **▶** to set.
8. Press any function key to quit and return to the ALARM menu. “” appears to the right of TRIP-DIST. When the alarm setting is violated the audible alarm sounds and an alarm message appears.
9. Press the **MENU** key to close the menu.

3.5.4 Disabling/enabling the audible alarm

1. Press the **MENU** key to open the menu.
2. Press **▲** to place the cursor on the main menu title field.
3. Press **◀** or **▶** to choose ALARM.
4. Press **▲** or **▼** to choose the alarm you want to process. (An alarm where or appears.
5. Press **◀** or **▶** to show or as appropriate.
6. Press the **MENU** key to close the menu.

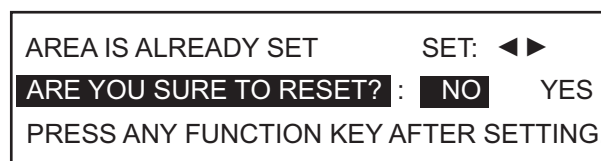

3.5.5 Disabling an alarm

1. Press the **MENU** key to open the menu.
2. Press **▲** to place the cursor on the main menu title field.
3. Press **◀** or **▶** to choose ALARM.
4. Press **▲** or **▼** to choose the alarm you want to disable.
5. Press any function key, and the following window appears.



6. Press **▶** to choose YES.

3. CUSTOMIZING THE SYSTEM

7. Press any function key to return to the ALARM menu. The  or  is removed.
8. Press the **MENU** key to close the menu.

4. MAINTENANCE & TROUBLE-SHOOTING

Periodic checks and maintenance are important for maintaining performance. This chapter contains maintenance and troubleshooting instructions to be followed to obtain optimum performance and the longest possible life of the equipment. Before attempting any maintenance or troubleshooting procedure, please review the safety information below.

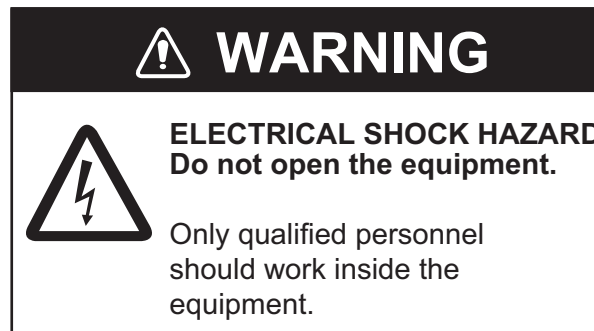

4.1 Routine Maintenance

General checks

Check the following monthly.

- Check all cabling. If damaged, replace.
- Check connectors on each unit for tight connection. Retighten if necessary.
- Check the ground on each unit. If rusted or dirty, clean.
- Measure the input voltage to be sure it is within the rated voltage.

Cleaning

Dust or dirt should be removed from exterior surfaces with a soft, dry cloth. For cleaning the LCD, wipe it carefully to prevent scratching, using tissue paper and an LCD cleaner. To remove stubborn dirt, use an LCD cleaner, wiping slowly with tissue paper so as to dissolve the dirt. Change paper frequently so the dirt will not scratch the LCD. Do not use chemical-based cleaners to clean the monitor unit - they can remove paint and markings.

Transducer

- Check the zinc plate attached to the transducer for corrosion regularly and replace it if it is corroded. It should be replaced when the ship is drydocked. If the plate is not replaced, corrosion may occur. This may allow the transducer to fall out from the hull, allowing water to leak inside the vessel.
- Do not paint the transducer face.
- When the vessel is drydocked, remove marine growth from the transducer. Marine life adhering to the transducer may cause a considerable drop in performance.

4.2 Replacing Fuses

The transceiver unit, monitor unit and control unit are equipped with a fuse which protects them from overvoltage and equipment fault. If a fuse blows, find the cause before replacing it. If it blows again after replacement, contact your dealer for advice. All fuses are located inside the units. Therefore, have a suitably qualified technician replace the fuses.

 WARNING
<p>Use the proper fuse.</p> <p>Use of a wrong fuse can result in damage to the equipment or cause fire.</p>

Unit	Type	Code No.
Monitor Unit	FGMB 3A 125V	000-104-909
Control Unit	FGMB 2A 125V	000-103-165
Transceiver Unit	FGBO-A 5A AC125V	000-549-064

4.3 Troubleshooting

Below are simple troubleshooting procedures which the user may follow to try to restore normal operation. If normal operation cannot be restored, do not attempt to check inside any unit. Any repair work is best left to a qualified technician.

Troubleshooting table

If...	Then...
nothing appears on the screen when the power switch is pressed	<ul style="list-style-type: none"> • check that the power cable is firmly connected. • The fuse may have blown. Request replacement of the fuse. • adjust brilliance.
ship's track is not displayed	<ul style="list-style-type: none"> • turn on SHIP TRACK in the DISP2 menu.
bottom echo is not shown on the echo level display	<ul style="list-style-type: none"> • check if the setting of ECHO RANGE in the MENU 1 menu is too low. • bottom is deeper than measuring range. • check setting of GAIN in the MENU1 menu.
echo display is interrupted	<ul style="list-style-type: none"> • suspect poor measuring conditions. • bottom is covered with sludge or the like. • marine life may be adhering to the transducer.
tide data is unstable	<ul style="list-style-type: none"> • adjust tide average on the MENU 1 menu.
interference is present	<ul style="list-style-type: none"> • check ground for corrosion. • check if the cables of other equipment are near the transducer cable.

4.4 Diagnostics

The current indicator is equipped with several test facilities to check it for proper operation.

4.4.1 General test

The general test mainly checks the ROM, RAM and voltages.

1. Press the **MENU** key to open the menu.
2. Press **▲** to place the cursor on the main menu title field.
3. Press **◀** to choose MENU 1.

MENU 1	MENU 2	ALARM	INSTALLATION
SHIP SPEED AVG :	<input type="text" value="15 sec"/>	30 sec	60 sec 90 sec
TIDE AVERAGE :	<input type="text" value="1 min"/>		
REF TIDE DIFF :	<input type="text" value="LAYER 1"/>	LAYER 2	LAYER 3
BEARING MODE :	<input type="text" value="32 CMPS"/>	360 TRUE	
NAV MODE :	<input type="text" value="OFF"/>	ON	
BOTTOM SEARCH:	<input type="text" value="NO"/>	YES	
BTM TIDE TRACK :	<input type="text" value="OFF"/>	ON	
ALM/KEY BEEP :	OFF	<input type="text" value="ON"/>	
WT SPD DEPTH :	<input type="text" value="2 m"/>	(2-250m)	
RESET TRIP LOG :	<input type="text" value="NO"/>	YES	
TEST :	<input type="text" value="NO"/>	GENERAL	PANEL PATTERN
ECHO RANGE :	<input type="text" value="150 m"/>		
TVG :	<input type="text" value="OFF"/>	ON	
GAIN :	<input type="text" value="5"/>	(1-40)	
PANEL DIMMER :	<input type="text" value="5"/>	(0-7)	
MENU ON INITIAL SETTINGS.			
[▲/▼]:SELECT, [◀/▶]: CHANGE, [MENU]: EXIT			

MENU 1 menu

4. Press **▲** or **▼** to choose TEST.
5. Press **▶** to choose GENERAL.

- Press any function key to start the test. The results of the test are shown on the screen as in the figure on the next page.

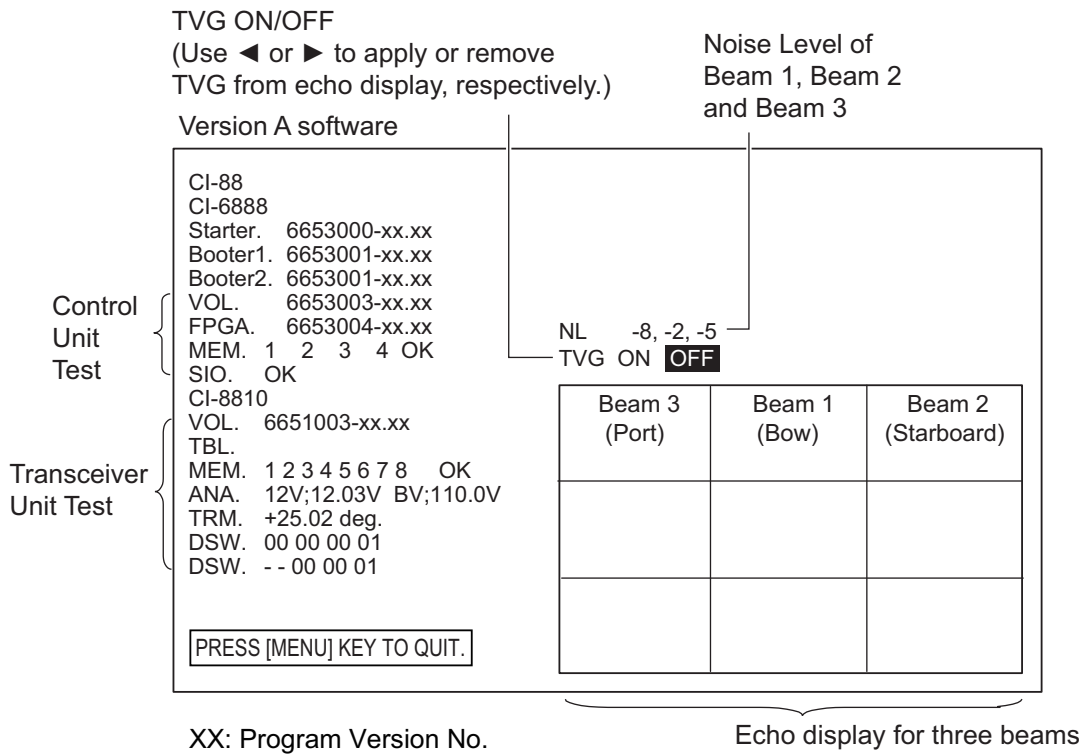

Diagnostic test results

Description of control unit test results

- VOL: Program version no. of the OCK Board (66P3982).
- MEM: Check of 1: ROM, 2: SRAM, 3: EEPROM and 4: DRAM
- SIO: Communication test with the transmission / reception calculation unit. If it is normal, "OK" will be displayed. If it is defective, "NG" will be displayed..

Description of transceiver unit test results

- VOL: Program version no. of the PCP Board (66P3920 A)
- MEM: Checks memory ICs on the PCP Board, NG. If all memory ICs are functioning properly, "OK" appears. "NG" (No Good) appears when an IC is abnormal and an asterisk is placed to the right of the abnormal IC.
- ANA: Displays voltage of 12 V and +B lines.
- TRM: Displays temperature inside transducer.
- DSW: Displays PCP DIP switch settings.
- DSW: Displays PCN DIP switch settings.

- To quit the test, press the [MENU] key to return to the MENU 1 menu.
- Press the **MENU** key again to close the menu.

4.4.2 Panel test

The panel test checks the keys and setting knob on the control unit for proper operation.

1. Open the MENU 1 menu and choose PANEL from TEST.
2. Press any function key to start the test. A screen for testing the control unit appears on the display.

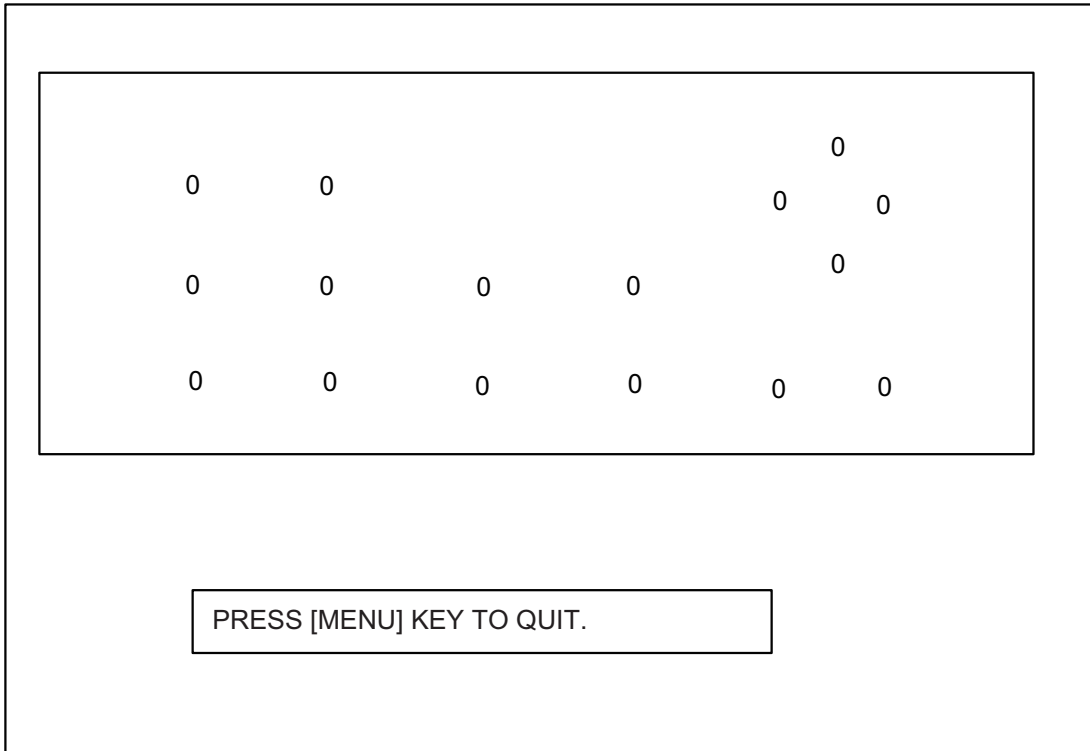

Panel test

3. Press each key (except [MENU] and [POWER]) one by one. A key's on-screen location should show "1" when the key is pressed and "0" when the key is released.
4. Operate the setting knob. The setting knob's on-screen indication should show appropriate setting value when the knob is operated.
5. To quit the test, press the **MENU** key to return to the MENU 1 menu.
6. Press the **MENU** key again to close the menu.

4.4.3 Test pattern

The test pattern checks for proper display of colors.

1. Open the MENU 1 menu and choose PATTERN from TEST.
2. Press any function key to start the test.

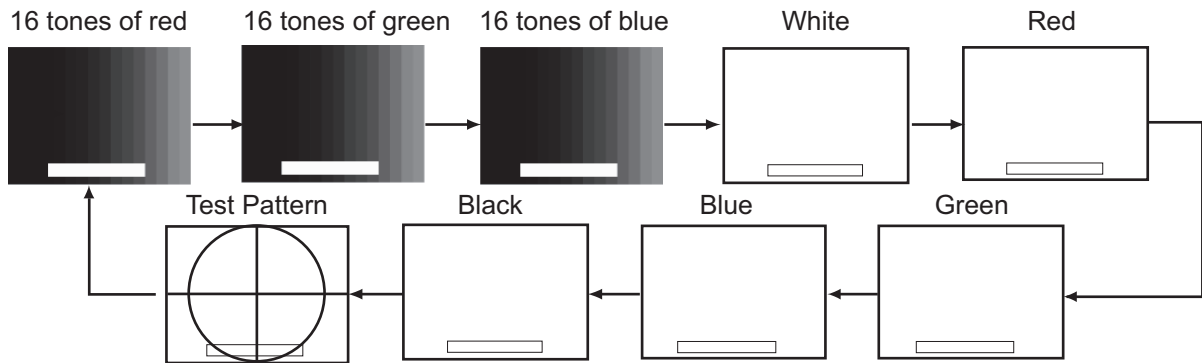

Test pattern

Note: When an external monitor is connected, it is 11 gradations instead of 16 gradations.

3. Press ► to change the picture in the sequence shown above. You may reverse the order by pressing ◀.
- Note:** Note: You may adjust the brilliance of the FURUNO-supplied monitor by operating the **BRILL** key.
4. To quit the test, press the [MENU] key to return to the MENU 1 menu.
 5. Press the **MENU** key again to close the menu.

4.5 Error Messages and Alerts

The current indicator displays an error message and sounds the audible alarm when error is detected. To silence the alarm, press any arrow on the CursorPad for transceiver-related alarm or turn off the alarm in the ALARM menu in case of control unit-related alarm. In case of multiple errors, the error or alert having the highest priority is displayed. The table below shows all the error messages and alerts which may appear, in order of priority, from highest to lowest.

Error messages and alerts

Error Message or Alert	Meaning
Error Message (from transceiver unit)	
WARNING! OVERHEATED TRANSDUCER [001]	Overheated transducer
WARNING! ABNORMAL TX VOLTAGE [002]	Abnormal Tx voltage
WARNING! CHARGING ERROR (+B) [003]	Abnormal +B voltage
WARNING! ABNORMAL INPUT 12V [009]	Abnormal Input voltage (12 V)
WARNING! NO POSITION DATA [100]	External position data is missing
WARNING! NO SPEED DATA [101]	External speed data is missing
WARNING! NO DEPTH DATA [103]	External depth data is missing
WARNING! NO HEADING DATA [104]	Position data is missing
WARNING! ABNORMAL COURSE DATA [105]	Abnormal course error angle
WARNING! NO TEMPERATURE DATA [106]	Water temperature data is missing
WARNING! ABNORMAL TEMP INPUT [201]	Abnormal water temperature sensor
Alert (from control unit)	
WARNING! LAYER 1 TIDE SPEED	Layer 1 speed alarm has been violated.
WARNING! LAYER 1 TIDE DIRECTION	Layer 1 tide direction alarm has been violated.
WARNING! LAYER 2 TIDE SPEED	Layer 1 speed alarm has been violated.
WARNING! LAYER 2 TIDE DIRECTION	Layer 1 tide direction alarm has been violated.
WARNING! LAYER 3 TIDE SPEED	Layer 1 speed alarm has been violated.
WARNING! LAYER 3 TIDE DIRECTION	Layer 1 tide direction alarm has been violated.
WARNING! SHALLOWER TIDE DIFF SPD	Shallow tide differential tide speed alarm has been violated.
WARNING! SHALLOWER TIDE DIFF DIR	Shallow tide differential tide direction alarm has been violated.
WARNING! DEEPER TIDE DIFF SPD	Deep tide differential tide speed alarm has been violated.
WARNING! DEEPER TIDE DIFF DIR	Deep tide differential tide direction alarm has been violated.
WARNING! SHIP SPEED	Speed alarm has been violated.
WARNING! SHIP COURSE	Course alarm has been violated.
WARNING! TRIP DISTANCE	Trip distance alarm has been violated.
WARNING! TRIP TIME	Trip time alarm has been violated.

APPX. 1 MENU TREE

Default settings shown in bold italic.

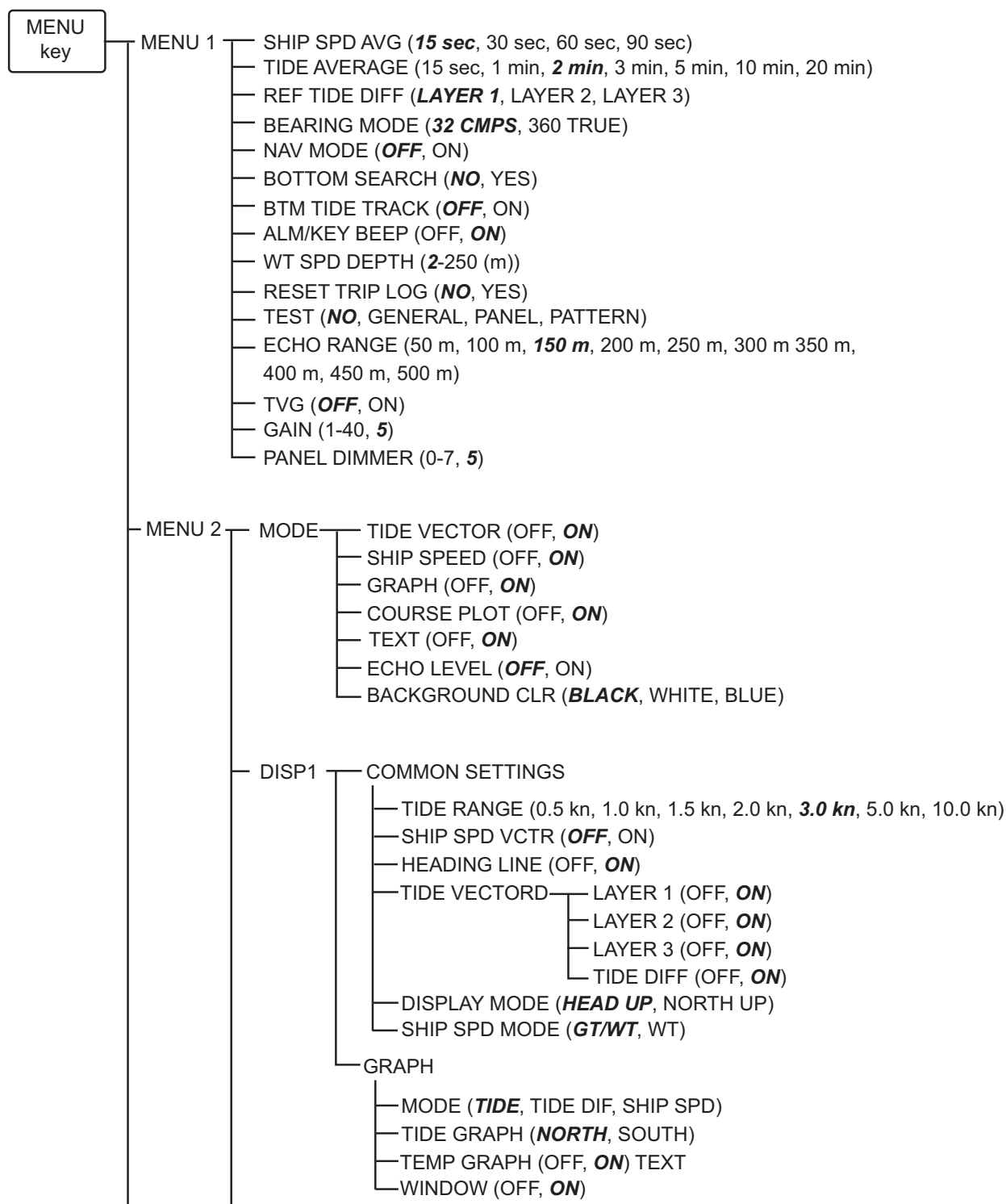

(Continued on next page)

APPX. 1 MENU TREE

(Continued from previous page)

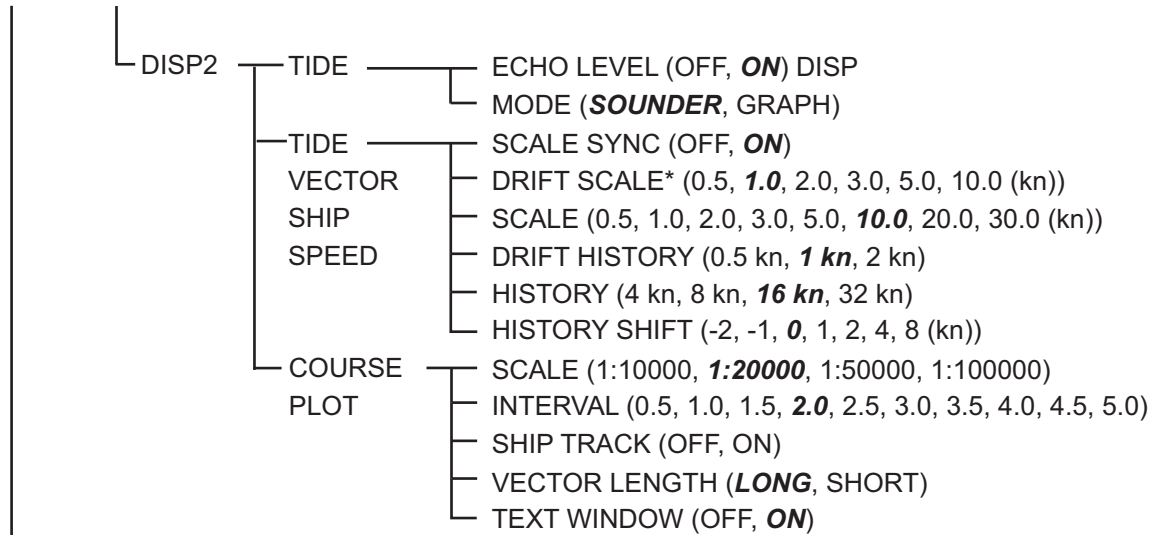

* Shown when SCALE SYNC is off.

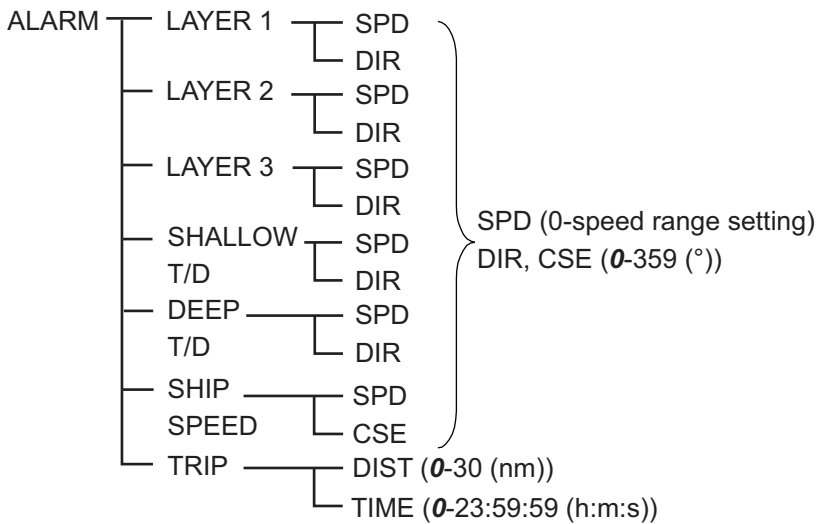

APPX. 2 TIDE MEASUREMENT IN NAV MODE

The accuracy of tide measurement in the NAV mode depends heavily on gyrocompass accuracy.

Setting ship's heading

The current indicator has a NAV mode which measures tides in deep waters where ground tracking is not available. To achieve reliable measurements, however, you must feed accurate heading (gyro) data and ship's position (or speed and course) data to the current indicator.

Procedure

1. Confirm that the gyro has settled and all necessary compensations (latitude compensation, weather compensation, etc.) have been made correctly.
2. Adjust the AD Converter to show the same reading shown on the master gyrocompass. (Do not make the adjustment while the ship is turning.)

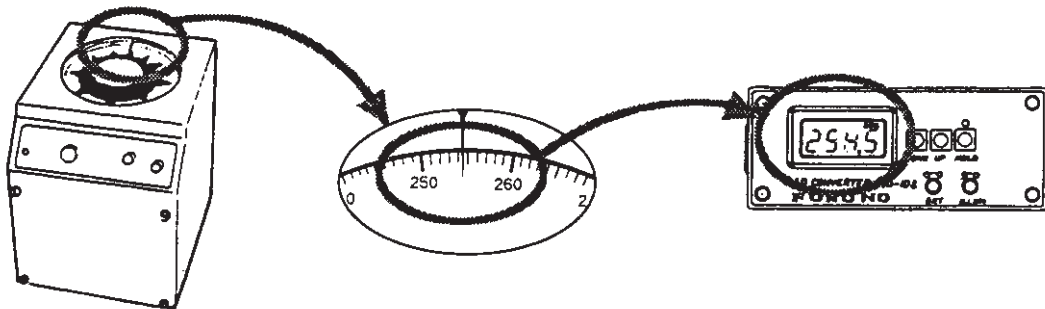

If the gyro reading is accurate, the current indicator will provide accurate tide information. If gyro data is wrong, the following symptoms will appear.

- The drift angle in the ground tracking mode is not the same as that in the nav mode or is shown in the direction reverse of the actual direction. Drift angle in ground tracking mode: Difference between ground speed and course and gyro heading.
Drift angle in nav mode: Difference between nav course and gyro heading
- Tide speed and direction in the ground mode is not the same as that in the nav mode. And the tide correlation (relative angle, size) between layers is different.

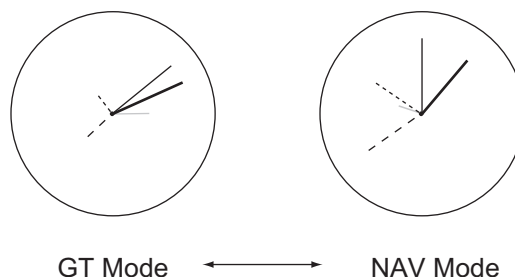

Appearance of tide vectors in ground tracking and nav modes when there is gyro error

If you encounter such symptoms calibrate the current indicator as shown in the installation manual.

Why gyro data is important in the NAV mode

If you consider the difference of tide vector calculations in the ground tracking mode and the NAV mode, you can see the importance of gyro (heading) data.

Tide calculation in the ground tracking mode

In the ground tracking mode, the current indicator derives tide information from the following data:

- (1) Ship's speed/course based on ground (ground speed)
- (2) Ship's speed/course based on target layer (water speed)
- (3) Bearing of ship's bow (heading by gyro)

Both ground speed (1) and water speed (2) are sensed by the common transducers mounted on the hull. Thus, they are the speed vectors with respect to the ship's bow. No matter what the true bearing of the ship's heading be, the relative angle of these two vectors does not change. The tide vector is simply given as the difference of these two speed vectors.

The heading data by gyro (3) is used after the tide vector calculation just to express the vector directions in true bearings (north referenced).

Even if the gyro data contains error, the sizes and relative angles of the vectors do not change. The gyro error only affects the bearing indication of each vector.

Tide calculation in the ground tracking mode

$$\left(\begin{array}{l} \theta_A: \text{True bearing of ship's bow (ref. north)} \\ \theta_H: \text{Gyro reading} \\ \theta_G: \text{Direction of ground speed (ref. bow)} \\ \theta_W: \text{Direction of water speed (ref. bow)} \end{array} \right)$$

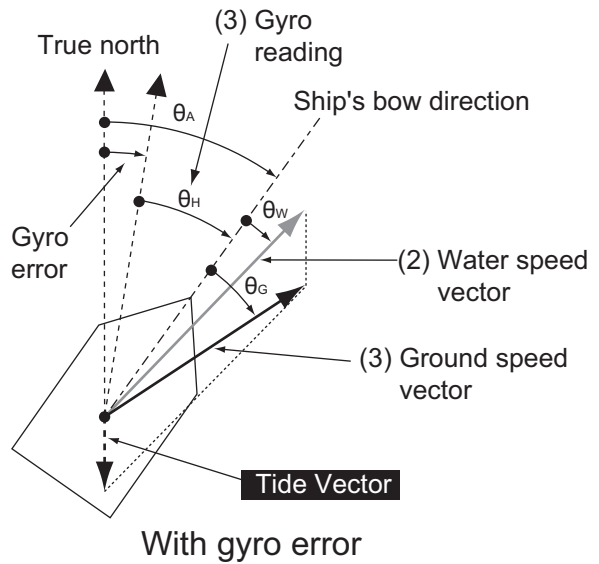
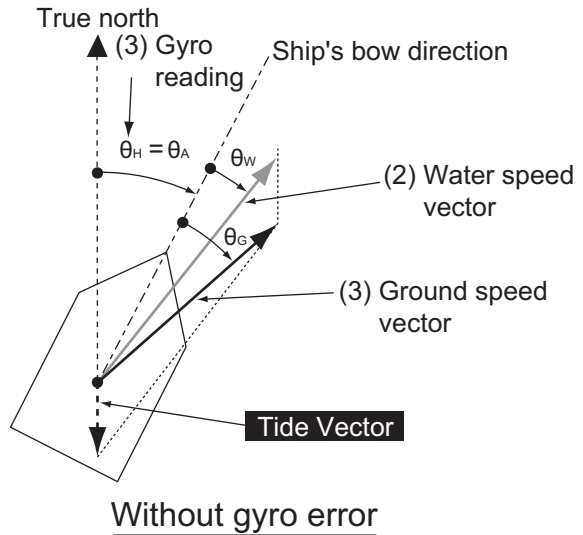

True bearing of each speed vector contains fixed error. But, their sizes and relative angles are maintained despite the gyro error.

Tide calculation in NAV mode

In the NAV mode, the current indicator derives tide information from the following data:

- (1) Ship's speed/course fed from navigator (GPS) (nav speed = pseudo ground speed)
- (2) Ship's speed/course based on target layer (water speed)
- (3) Bearing of ship's bow (heading by gyro)

Here, nav speed (1) is the ship's speed vector sensed by the navigator, and the moving direction is expressed with respect to true north.

While the water speed (2) is the ship's speed vector measured by the current indicator using the Doppler shifts against the measuring layer, and accordingly its direction is expressed with respect to the ship's bow.

As the directional reference of these two vectors are different (north vs ship's bow), we can not simply calculate the difference of vectors to obtain the tide vector in question.

So the direction of the water speed vector (2) is converted to true bearing (north referenced) by using the gyro data, and then the tide vector is calculated.

If the gyro data contains error, the true bearing of the water speed vector changes (rotates) accordingly. While the bearing of the nav speed vector does not change with the gyro error. (The relative angle of these two changes.)

In other words the tide vector, given as a difference between these two speed vectors, changes in size (speed) and bearing by the gyro error. (Error in size and bearing means the tide vector is unreliable and useless.)

To obtain dependable tide/tide differential data, it is desirable to reduce the gyro error below 1degree.

Note that the depth must be at least 40 m in order to calculate tide.

- θ_A : True bearing of ship's bow (ref. north)
- θ_H : Gyro reading
- θ_N : True bearing of nav speed (ref. north)
- θ_W : Direction of water speed (ref. bow)

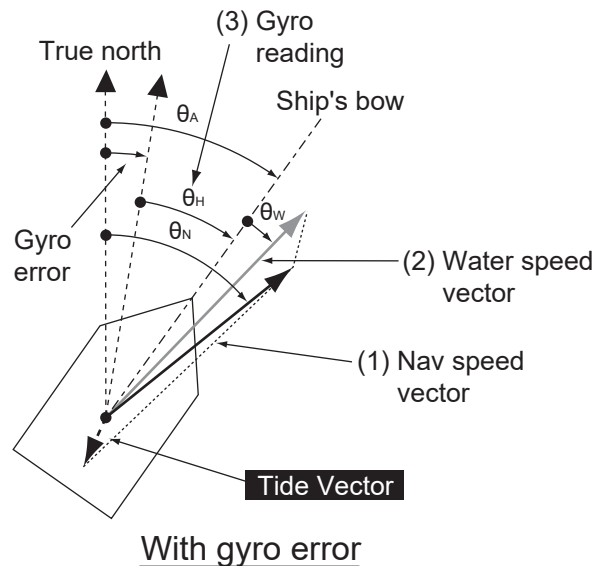
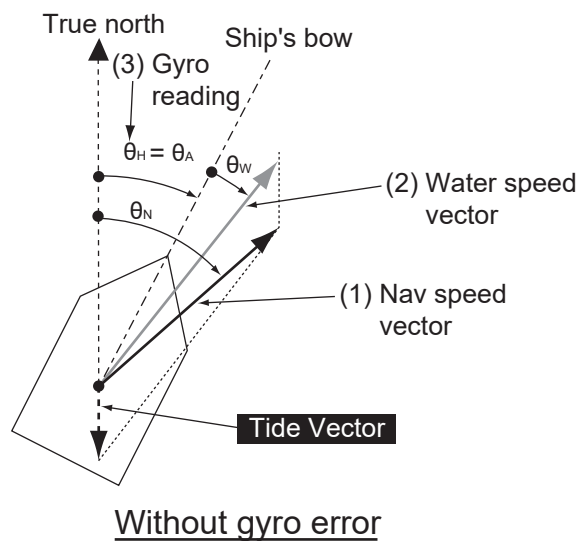

Relative angle of water speed vector and nav speed vector changes with gyro error. Accordingly, the size (speed) and direction of tide vector change.

APPX. 3 PRINCIPLE OF OPERATION

When a moving vessel emits an acoustical pulse into the water at an angle, a portion of the emitted energy is reflected from the bottom and other microscopic objects in the sound path, such as plankton or air bubbles. The frequency of the received signal is shifted from the transmitted frequency in proportion to the relative velocity between the vessel and underwater reflecting objects. This is called the Doppler Effect.

This equipment calculates and displays movements of ship and currents at specific depths by measuring Doppler shifts obtained from three separate directions.

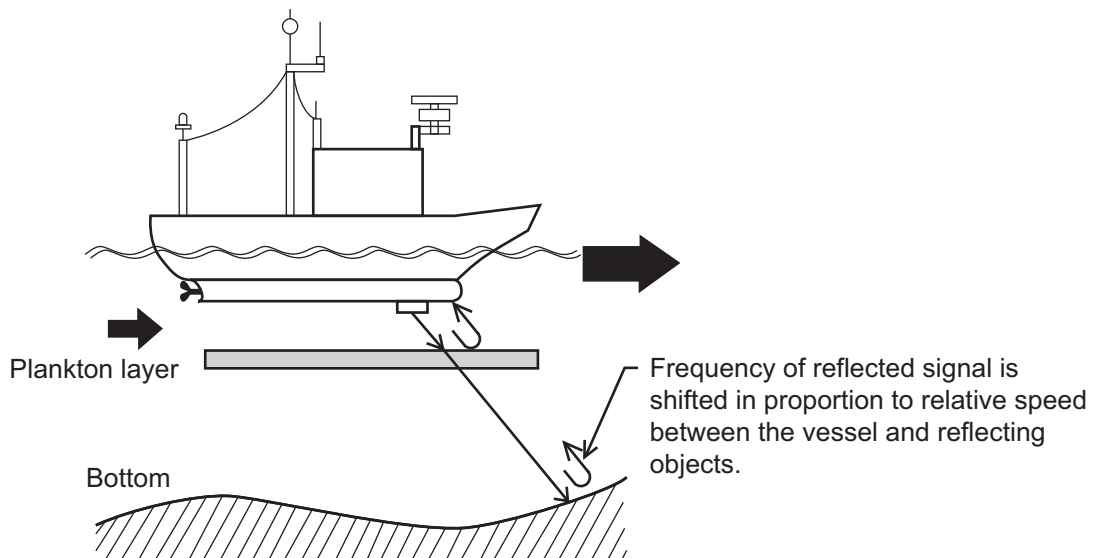

Ship's Speed

(Here, speed is a vector value including velocity and direction.)

Depending on the base of measurement, ship's speed is expressed in two ways:

- Ground tracking speed:** Ship's speed and course relative to bottom (fixed base)
(Absolute speed)
- Water tracking speed:** Ship's speed and course relative to water layer just below the vessel (floating base)
(Relative speed)
- Navaid-generated speed:** Ship's speed and course obtained by external navigation equipment (GPS)
(Absolute speed)

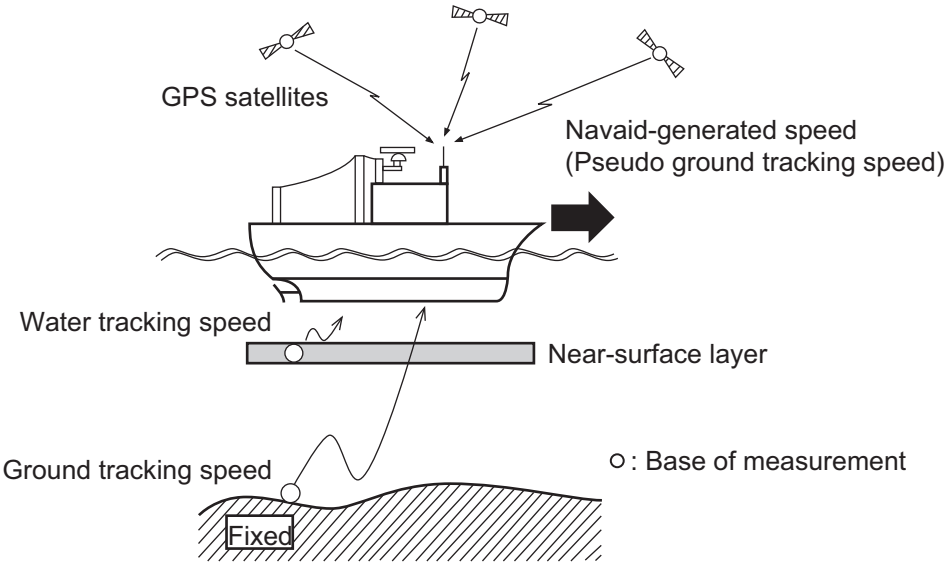

Tide

Tide is the movement of watermass at a particular depth.

To know absolute tide (speed on ground), the following two data are required:

- 1) Ship's speed and course based on ground
- 2) Ship's speed and course based on measuring layer (A)

Absolute tide is, then, given as a difference of these two speed vectors.

Absolute Tide = (1) - (2)

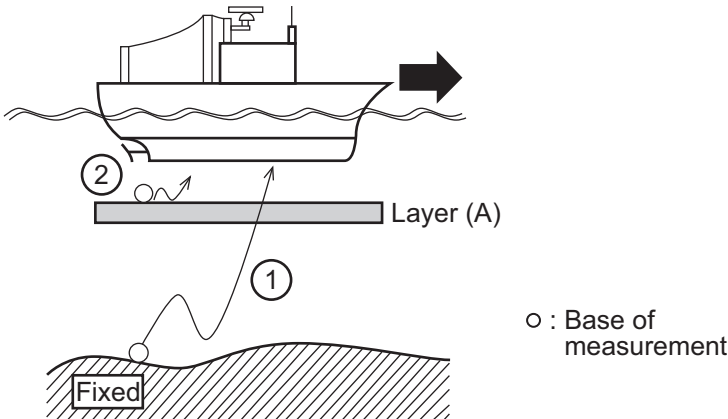

Tide Differential

Tide differential is a relative movement of tides at different depths, layer (A) and layer (B).

To calculate tide differential, the following two data are used:

- 1) Ship's speed and course based on layer (A)
- 2) Ship's speed and course based on layer (B)

Tide differential between two layers is, then, given as a difference of these two speed vectors.

Tide Difference = (1) - (2) (Movement of layer B based on layer A)

Or

= (2) - (1) (Movement of layer A based on layer B)

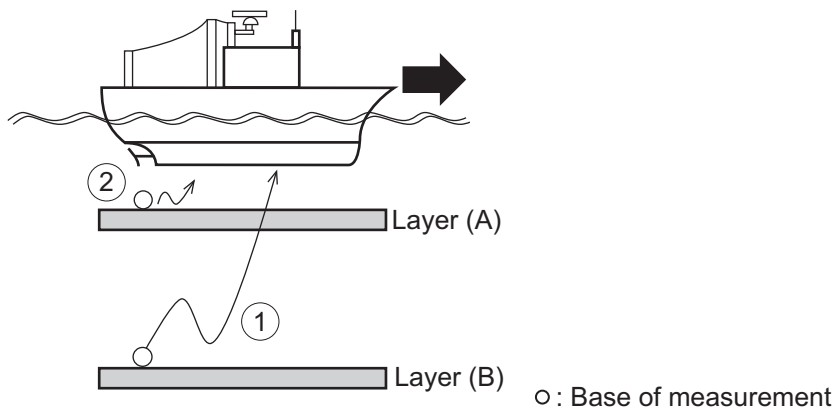

APPX. 4 Tide, Nav-tide and Tide Differential

Tide (absolute tide)

Absolute tide can be measured in the ground tracking mode.

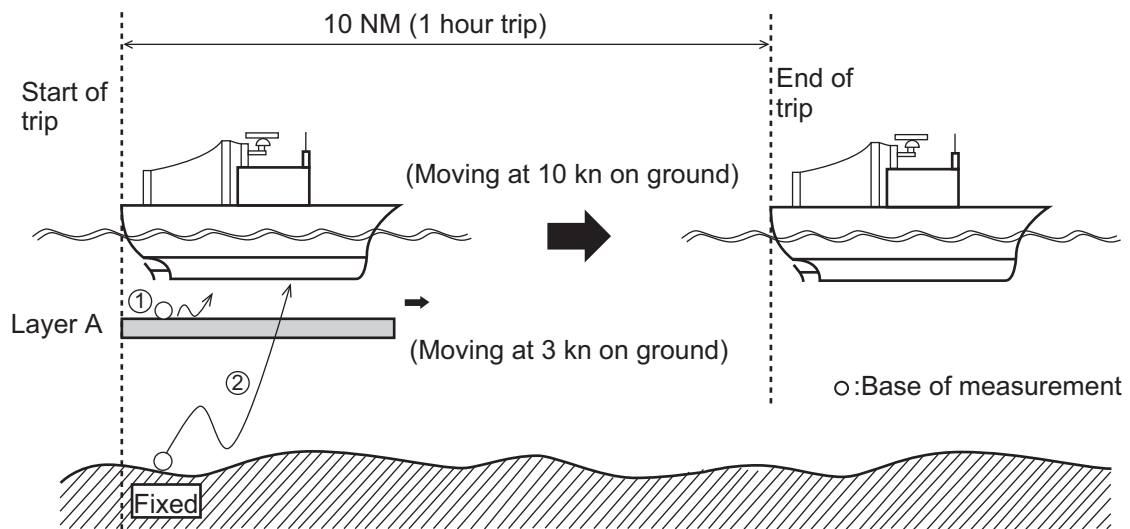

Assume that the ship and layer A are moving in the same direction, and ship's speeds based on ground (V_g) and on layer A (V_{wa}) are measured as;

$V_g = 10$ kn (Ship's speed based on ground)

$V_{wa} = 7$ kn (Ship's speed based on layer A).

Speed of layer A based on ground (C_1) can be calculated as follows:

$$C_1 = V_g - V_{wa}$$

$$= 10 - 7$$

$$= 3 \text{ (kn)}$$

Tide differential

Tide differential is a relative movement of tides at different depths.
 It can be measured in the ground tracking, water tracking and NAV modes.

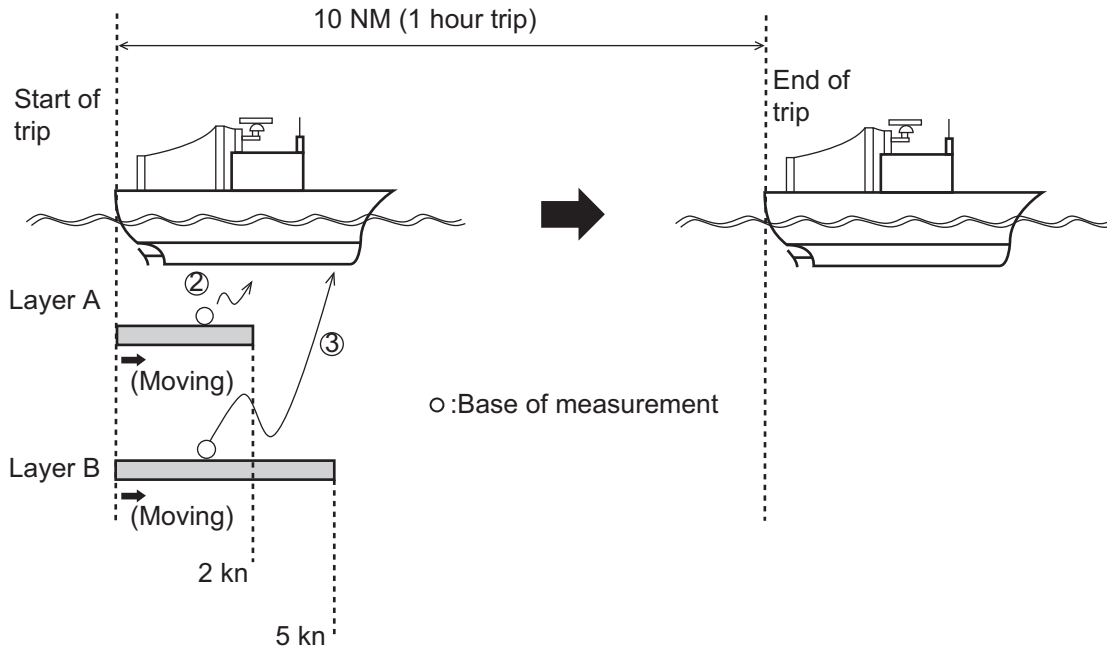

Assuming that the ship, layer A and layer B are moving in the same direction, and ship's speeds based on layer A (V_{wa}) and on layer B (V_{wb}) are measured as;

$V_{wa} = 8 \text{ kn}$ (Ship's speed based on layer A)

$V_{wb} = 5 \text{ kn}$ (Ship's speed based on layer B)

Tide differential calculations in ground tracking mode

As an absolute ship's speed (V_g) is available in the ground tracking mode, tide speeds of layer A (C_1) and layer B (C_2) based on ground are calculated as follows:

$C_1 = V_g - V_{wa}$ (Speed of layer A based on ground)

$C_2 = V_g - V_{wb}$ (Speed of layer B based on ground)

Thus, the tide differential (C_d) between layer A and layer B is;

Tide differential based on layer A (speed of layer B as viewed from layer A)

$$\begin{aligned} C_d &= C_2 - C_1 \\ &= (V_g - V_{wb}) - (V_g - V_{wa}) \\ &= V_{wa} - V_{wb} \\ &= 8 - 5 \\ &= 3 \text{ (kn)} \end{aligned}$$

OR

Tide differential based on layer B (speed of layer A as viewed from layer B)

$$\begin{aligned} C_d &= C_2 - C_1 \\ &= (V_g - V_{wa}) - (V_g - V_{wb}) \\ &= V_{wa} - V_{wb} \\ &= 5 - 8 \\ &= 3 \text{ (kn)} \end{aligned}$$

In the water tracking mode, watermass just below the transducer (near-surface layer) is taken as the base of all measurements (virtual ground). Therefore, the ship and tide speeds in the water tracking mode are not absolute but relative to this near-surface layer.

- Vw = 9 kn (Ship's speed based on near-surface layer)
- Vwa = 8 kn (Ship's speed based on layer A)
- Vwb = 5 kn (Ship's speed based on layer B)

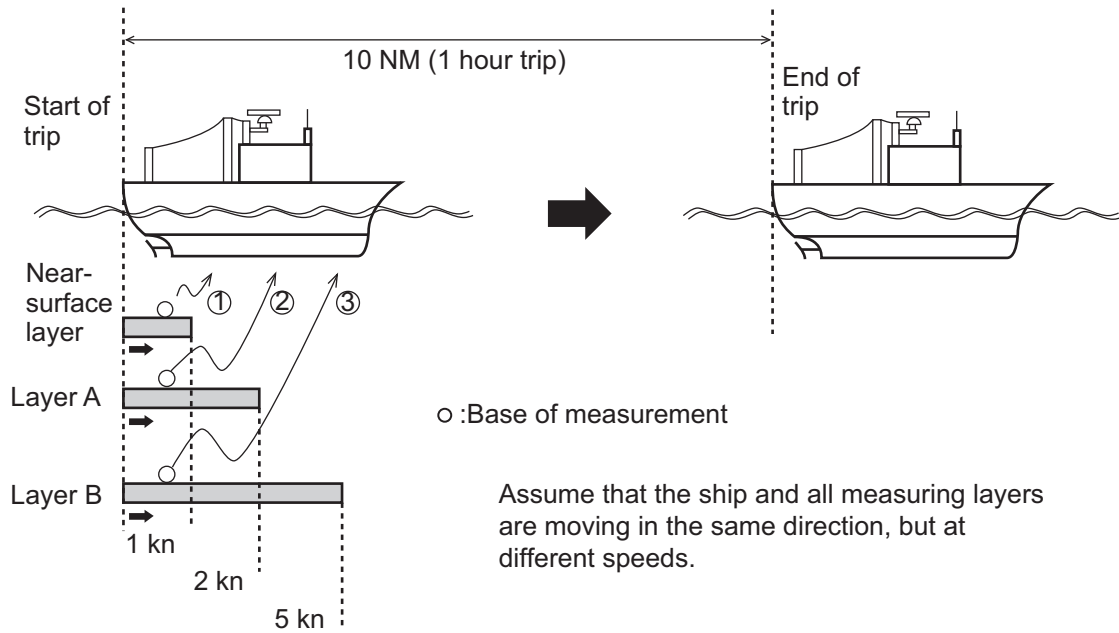

Tide differential calculations in water tracking mode

Tide speeds of layer A (C1) and layer B (C2) relative to near-surface layer (Vw) are calculated as follows:

Tide differential based on layer A (speed of layer B as viewed from layer A) $D1 = Vw - Vwa$ (Speed of layer A based on near-surface layer)

$D2 = Vw - Vwb$ (Speed of layer B based on near-surface layer)

The tide differential (Dd) between layers A and layer B is;

$$\begin{aligned} Dd &= D2 - D1 \\ &= (Vw - Vwb) - (Vw - Vwa) \\ &= Vwa - Vwb \\ &= \mathbf{8 - 5} \\ &= 3 \text{ (kn)} \end{aligned}$$

OR

Tide differential based on layer B (speed of layer A as viewed from layer B)

$$\begin{aligned} Dd &= D2 - D1 \\ &= (Vw - Vwa) - (Vw - Vwb) \\ &= Vwa - Vwb \\ &= \mathbf{5 - 8} \\ &= 3 \text{ (kn)} \end{aligned}$$

OR

If you compare the results of calculations on this page with the ones on preceding pages, you will find the tide differential of two layers is identical irrespective of tracking mode.

**SPECIFICATIONS OF DOPPLER SONAR CURRENT INDICATOR
CI-88**

1 TIDE

- 1.1 Speed 0.0-9.0 kn
- 1.2 Accuracy Within 0.2 kn
- 1.3 Direction All directions in one-degree steps (360°)
- 1.4 No. of measuring layers 3
- 1.5 Range of measurement 2-100 m
Up to 75% of depth. The depth must be greater than 10 m in the ground tracking mode and greater than 40 m in the water tracking mode using “normal” pulse and greater than 70 m using long pulse. Actual range will vary depending on installation and underwater conditions.

2 SPEED

- 2.1 Speed Fore-aft: -10.0 to 30 kn
Port-stbd: -9.9 to +9.9 kn
- 2.2 Accuracy Within ±1% or 0.1 kn, whichever is the larger
- 2.3 Direction All directions in one-degree steps (360°)
- 2.4 Depth of measurement (ground tracking mode) 3-200 m (Actual depth depends on installation method and underwater conditions.)

3 DISPLAY

- 3.1 Display VGA (640x480 dot)
Content: Ship’s speed, Course, Drift angle, Tide (3 layers), Tide differential (2 layers), Setting depth, Heading, Position, Echo level, Water temperature
Displays: Tide vector, Graph, Course plot, Ship’s speed, Text, Echo monitor

4 TRANSMISSION

- 4.1 Frequency 288 kHz
- 4.2 Tilt angle 60°

5 FUNCTIONS

- 5.1 Modes of measurement Ground tracking, Water tracking, Nav-aided, Automatic
- 5.2 Functions Bottom tide tracking, Alarm output, Interference rejecter, Demonstration mode
- 5.3 Corrections Ship’s speed, Tide, Installation angle (bearing error, trim, heel), Course error, Draft, External KP range

6 INTERFACE

- 6.1 Format Current loop, NMEA 0183 ver. 1.5/2/0/3.0, IEC 61162-1 Ed. 2
IEC 61162-2, current indicator (FURUNO's own format)
- 6.2 NMEA input sentences ZDA, RMC, RMA, GGA, GLL, VTG, HDT, HDM, HDG, DBT, DPT,
MTW
- 6.3 NMEA output sentences VBW, VDR, VHW, VTG, VLW, CUR
- 6.4 CIF input sentences System time, Measuring position, Heading, Bearing, Depth, Water
Temperature
- 6.5 CIF output sentences Tide data for 1st layer, Tide-measured speed, Depths for multi-layers
- 6.6 Current indicator data Date and time data, Position data, Speed data,
Current indicator data, Reverberation level data,
Speed calibration data, Angle calibration
data, Alarm output data, others

7 POWER SUPPLY

- 7.1 Transceiver unit, 24 VDC, 2.5A (includes monitor and control unit)

8 ENVIRONMENTAL CONDITIONS

- 8.1 Temperature
 - Transducer -5°C to 35°C
 - Other units -15°C to 55°C
- 8.2 Relative humidity Less than 95% (40°C)
- 8.3 Degree of protection
 - Monitor/ transceiver unit IPX0
 - Control unit IPX2 (panel), IPX0 (rear)
 - Junction box IPX4
 - Transducer IPX8

9 UNIT COLOR

- 9.1 Monitor unit Panel: N3.0, Cover: 2.5GY5/1.5
- 9.2 Control unit Panel: N3-2, Cover: 2.5GY5/1.5
- 9.3 Transceiver unit 2.5GY5/1.5

INDEX

A

ALARM menu	3-11
Alarms	
disabling audible alarm	3-15
disabling/enabling	3-15
ship's speed	3-12
tide differential	3-12
tide speed and direction	3-12
trip alarm (distance)	3-14
trip alarm (time)	3-15

B

Background color	3-7
Bearing mode	3-4
Bottom search	3-5
Bottom tide tracking	3-5
BRILL key	1-2
Brilliance	1-2

C

Control description	1-1
Course plot display	
description	2-9
on/off	3-7
overview	1-5

D

Diagnostics	
general test	4-4
panel test	4-6
test pattern	4-7
DISP MODE key	1-3
DISP1 menu	3-7
DISP2 menu	3-9

E

Echo level display	
description	2-11
on/off	3-7
overview	1-6
Echo range	3-5
Electronic bearing scale	2-5
Error display	2-11
Error message	4-8

F

Function keys	3-3
Fuse replacement	4-2

G

Gain	3-6
General test	4-4
Graph display	
description	2-7
mode	3-8
on/off	3-7
overview	1-4

temperature display	3-8
Graph text	3-8

H

Heading	2-2
Heading line	2-4
Heading line on/off	3-7
Head-up	3-8
History graph	2-6
History settings	3-10

K

Key beep	3-5
----------------	-----

L

Layer vector on/off	3-8
LYR keys	1-7

M

Maintenance	
fuse replacement	4-2
routine	4-1
MENU 1 menu	3-4
MENU 2 menu	3-6
MENU key	3-1
Menu tree	AP-1
Mode marker	2-2
MODE menu	3-6

N

NAV mode	3-4
North mark	2-9
North-up	3-8

P

Panel dimmer	3-6
Panel test	4-6
POWER switch	1-2

R

RANGE key	1-9
-----------------	-----

S

Scale	2-9, 3-10
Scale sync	3-10
Ship's speed averaging	3-4
Ship's speed display	
description	2-5
on/off	3-6
overview	1-4
Ship's speed mode	3-8
Ship's speed vector on/off	3-7
Ship's track display on/off	3-10

T

Test pattern	4-7
Text display	
on/off	3-7
overview	1-5

INDEX

Tide averaging	3-4
Tide differential reference layer	3-4
Tide log resetting	3-5
Tide vector	2-4
interval.....	3-10
length	3-10
Tide vector display	
description.....	2-1
on/off	3-6
overview.....	1-3
TRACK MODE key	1-8
Trip distance marker	2-8
Troubleshooting	4-3
TVG.....	3-6

W

Water tracking speed depth	3-5
----------------------------------	-----



Declaration of Conformity



We **FURUNO ELECTRIC CO., LTD.**

(Manufacturer)

9-52 Ashihara-Cho, Nishinomiya City, 662-8580, Hyogo, Japan

(Address)

declare under our sole responsibility that the product

DOPPLER SONAR CURRENT INDICATOR CI-88

(Model name, type number)

to which this declaration relates conforms to the following standard(s) or other normative document(s)

EU

EMC Directive 2014/30/EU

IEC 60945 Ed.4.0: 2002

For assessment, see

- Test report
Furuno Labotech International Co., Ltd.
FLI 12-03-034, 1 Aug 2003

UK

SI 2016 No.1091 EMC Regulations 2016 as amended

EN 60945: 2002

For assessment, see

- Test report
Furuno Labotech International Co., Ltd.
FLI 12-03-034, 1 Aug 2003

(title and/or number and date of issue of the standard(s) or other normative document(s))

On behalf of Furuno Electric Co., Ltd.

Nishinomiya City, Japan
26 July 2021

(Place and date of issue)

Akihiko Kanechika
Department General Manager
Quality Assurance Department

(name and signature or equivalent marking of authorized person)