

**FURUNO**

# NAV*pilot*

Model NAVpilot-700/711C

**AUTOPILOT**



[www.furuno.com](http://www.furuno.com)

# Kick back, relax and let NAVpilot steer you to your destination!



Model NAVpilot-700



Model NAVpilot-711C

FURUNO NAVpilot is a revolutionary autopilot designed for a variety of vessels. It utilizes a self-learning and adaptive software algorithm, and plays the ultimate role in course keeping capability dynamically adjusting essential parameters for navigation i.e., vessel speed, trim, draught, tide and wind effects, dead band, weather, etc. These parameters are stored in the system memory and continuously optimized.

## Graphic displays for NAVpilot-711C

Several types of the graphic displays are available, allowing you to customize the data to suit your own preferences with either digital or analog graphics. The NAVpilot-711C features a color day/night graphic display, giving you much better sunlight viewability during the day, while not affecting your night vision when the sun goes down.

NEW



SABIKI

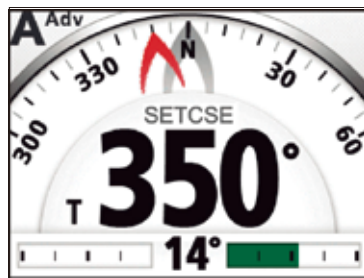

Compass

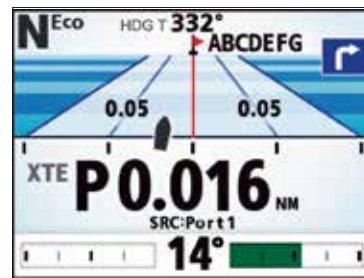

Highway



Wind



Rudder



Engine Speed

### Night Version



Auto mode



Highway

### Display modes for NAVpilot-700

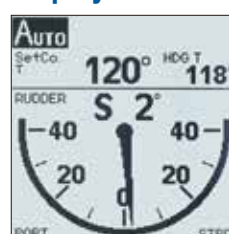

Rudder Angle

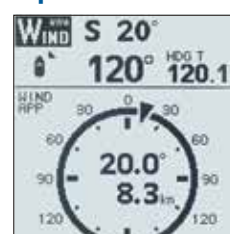

Wind

- ▶ Furuno Fantum Feedback™ - allows for no physical rudder feedback unit for a streamlined installation and precise course control
- ▶ Selectable "Economy" and "Precision" Navigation Modes combine adaptive technology providing fuel and power savings of up to 2.5% or more.\*
- ▶ Volvo Penta IPS, YAMAHA Helm Master™, Yanmar 8LV compatible
- ▶ "Precision" XTE accuracy: within 0.003 nm

- ▶ Perfect for inboard or outboard power boats and sail boats
- ▶ Simple one-touch mode selection enables flexible steering and course control
- ▶ Autopilot control available from NavNet TZtouch2/TZtouch
- ▶ Optional revolutionary SAFE HELM and POWER ASSIST brings unrivaled steering control and comfort at the helm\*\*

\* Based on Furuno testing and "Scenarios for a Clean Energy Future 2000" - U.S. Department of Energy ([www.ornl.gov/sci/eere/cef](http://www.ornl.gov/sci/eere/cef))

\*\* Required Options - HRP11 or HRP17 Pump and FPS8 Power Steering Module



NAVipilot's remarkable self-learning, adaptive software is developed by collaborative works between FURUNO and FLSI.

## Self-learning and adaptive software

From the first dock-side setup through the last voyage you made, NAVipilot continues to learn your vessel's steering characteristics. This allows dynamic adjustments to the boat's steering for vessel speed, trim, draft, tide and wind effects, weather, etc. These characteristics are stored in the processor's memory where they are continuously optimized to make the NAVipilot more versatile.

### Auto mode



NAVipilot consistently maintains the desired heading, but the vessel may drift off course due to the effects of tide and wind.

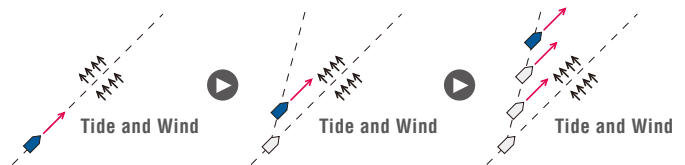

### Advanced auto mode



NAVipilot consistently maintains the desired heading while compensating for the effects of tide and wind.

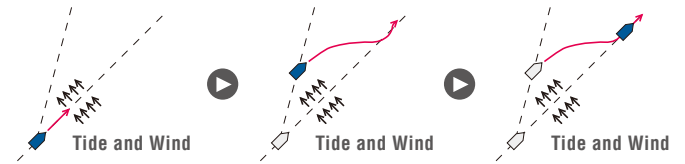

### SABIKI mode NEW



NAVipilot consistently maintains the desired heading astern while compensating for the effects of tide and wind. Speed is limited to 5 knots.

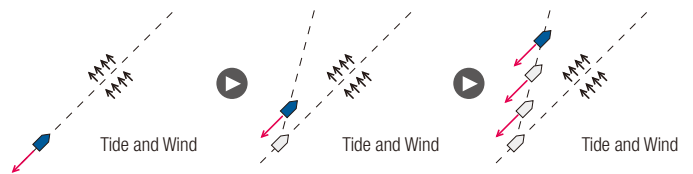

### NAV mode / Route tracking



NAVipilot steers the vessel towards the current waypoint while compensating for the effects of tide and wind.

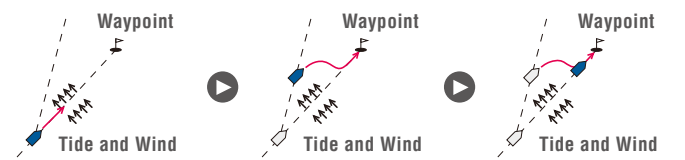

When connected to a GPS Navigator, NAVipilot steers the vessel to follow a series of waypoints in succession. Upon arriving at each waypoint or destination, audible and visual alerts are activated.

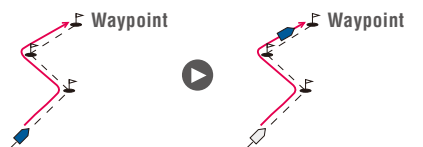

### Wind mode\*



NAVipilot consistently maintains the desired heading toward true or apparent wind direction while compensating for the effects of tide and wind.

\* This mode is available for sailing craft only. Wind data input is required.

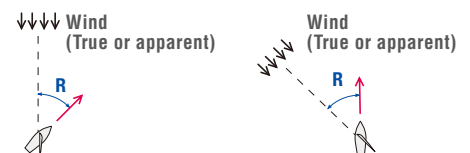

## FishHunter

The NAVpilot will activate the FishHunter to perform square, zigzag, circle, orbit, spiral or figure eight maneuvers around the specified target at a user selected distance. This feature can also be used for Man Overboard (MOB).

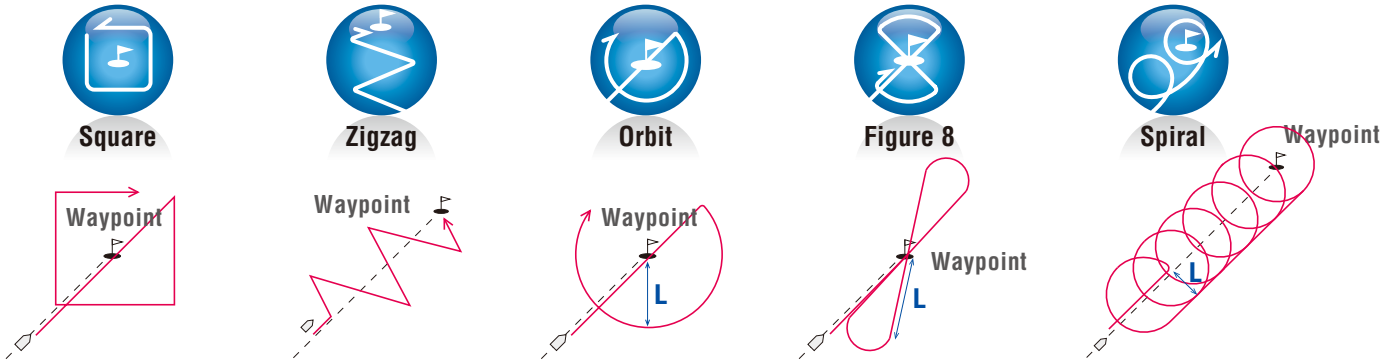

## SABIKI mode for NAVpilot-711C

NEW

With the brand new SABIKI mode your NAVpilot-711C has just become even more capable than before. And the best thing, there is no need to install additional hardware or sensors. Just perform the automated software upgrade and the SABIKI mode will be added to your NAVpilot-711C. SABIKI mode is only available on vessels with outboard engines.



### Sabiki "ON"

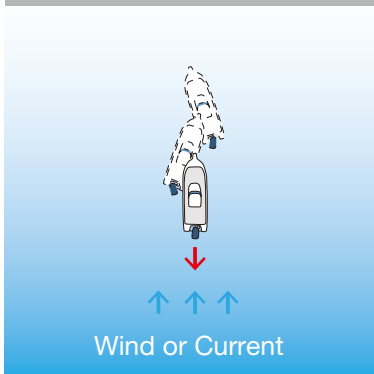

With the SABIKI mode turned on, the direction can be kept just by adjusting the throttle.

### Sabiki "OFF"

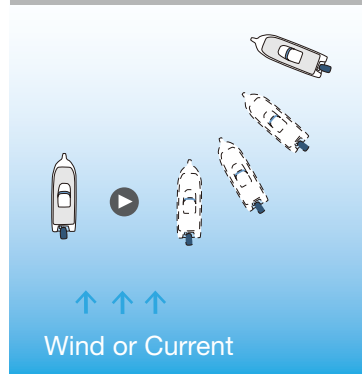

In order to keep the same direction it is not sufficient to just reverse the engine and move astern. The steering has to be constantly adjusted to keep direction.

SABIKI mode lets the autopilot control while you are drifting astern, so you can focus on fishing instead of steering. Moving astern at a slow pace the SABIKI mode is uniquely tailored for sabiki fishing, jigging and bottom fishing. Sabiki fishing requires a bit of technique and no matter if you just started or have considerable experience, the SABIKI mode will help you catch the bait fish needed for the big catch.



After performing the software upgrade, a SABIKI icon will appear in the turn menu. The SABIKI mode is only user selectable if the current speed is below 5 knots. Once SABIKI mode is selected, the course can be set with the Roto knob and the arrow keys.

## SAFE HELM / POWER ASSIST



The optional SAFE HELM and POWER ASSIST features\* provide a unique interface to the vessel's hydraulic hand steering system, providing unrivaled comfort and control of the vessel's steering directly from any manual helm on the vessel. These two modes greatly reduce steering effort and enhance the safety of your vessel's autopilot. \* Required Options - HRP11 or HRP17 Pump and FPS8 Power Steering Module

### SAFE HELM

The SAFE HELM temporarily switches the NAVpilot to manual steering for a specified time interval, taking it out of an automatic steering mode (AUTO, NAV, etc.) After the time interval has elapsed, SAFE HELM is deactivated and the previous automatic steering mode is restored.

### POWER ASSIST

The POWER ASSIST is a unique helm-activated assisted steering feature that can augment and possibly replace separate electric and power-robbing, engine-driven power steering systems on many vessels. POWER ASSIST reduces steering system complexity and costs while increasing economy.





## Interlocking system with EVC engines

NEW

The NAVpilot-711C works with a wide variety of boats and engines, including power and sail boats, with inboard or outboard engines. It even has the capability to work with Volvo Penta IPS, Yamaha Helm Master™ and Yanmar 8LV engine systems.



Volvo Penta IPS system

(Compatible with Volvo Penta IPS drive versions C, D or E type.)



Yanmar Joystick Control System

(Compatible with Yanmar 8LV and JC10)



Yamaha Helm Master™ system

FURUNO IF-700IPS (IPS Interface Unit) is an optional unit to integrate with the innovative propulsion system. The IPS Interface Unit relays command from NAVpilot-700 series to the engines to steer the vessel.

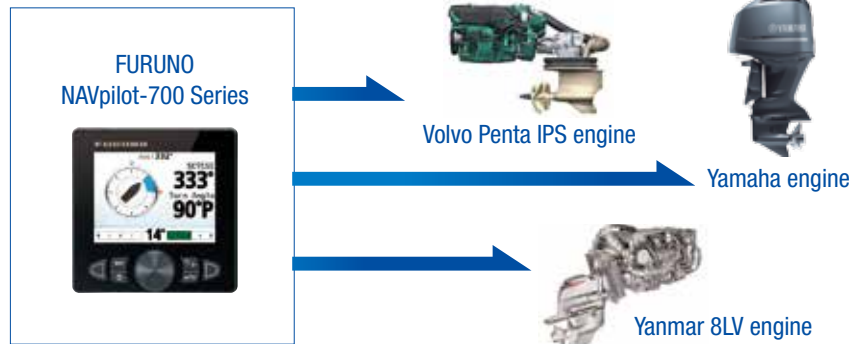

## Furuno Fantum Feedback™



FURUNO with Fantum Feedback™, NAVpilot outboard/sterndrive installations no longer require use of a physical rudder feedback unit. Fantum Feedback™ NAVpilot software clears the path to a simplified installation, while also delivering enhanced steering control.

This streamlined installation, combined with FURUNO's unique adaptive learning Autopilot technology, provides unmatched outboard outboard/sterndrive Autopilot performance. Fantum Feedback™ is a menu-selectable feature available in the latest NAVpilot-700 series software. This new software was developed and extensively tested on a wide variety of outboard/sterndrive vessels with hydraulic steering and reversing pump control. Fantum Feedback™ achieves precise course control, from slow trolling speeds to high-speed cruising, utilizing a newly developed, time-based rudder gain process, rather than traditional rudder angle based control.





## Perfect match!

Furuno NAVpilot-711C is designed to match the new NavNet TZtouch2, NavNet TZtouch and new FI-70 Instrument/Data organizer and other navigation equipment. The "Plug and Play" CAN bus interface allows for easy installation and exceptional interface ability. The diagrams below show typical installations for power and sail boats.



## POWER BOAT

(Outboard/Sterndrive)

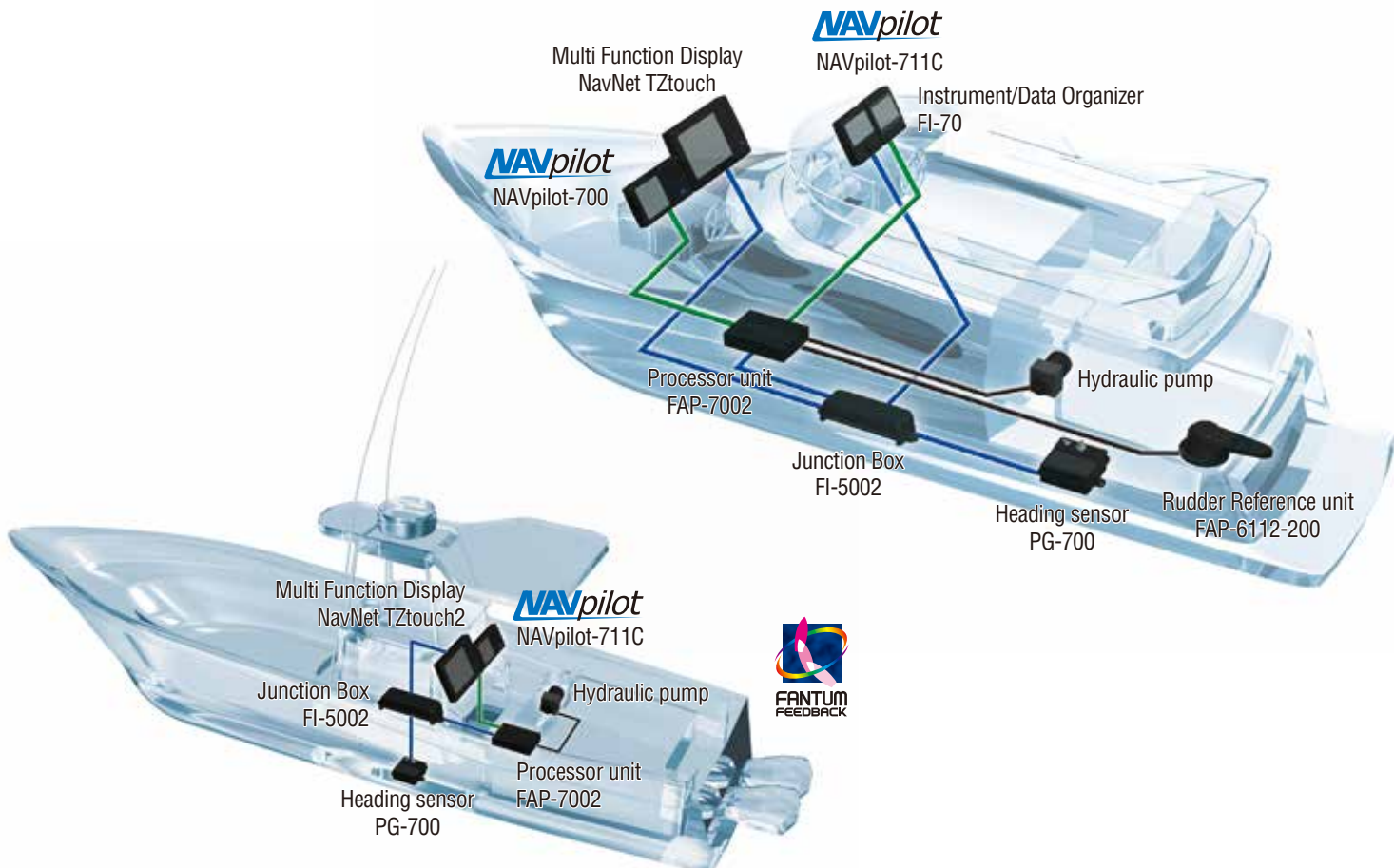



## Autopilot control by NavNet TZtouch2/TZtouch



If you have your boat equipped with a NavNet TZtouch2 or TZtouch system you can take full advantage of the NAVpilot-700/711C from the NavNet TZtouch series display. You can activate the AUTO mode of the NAVpilot-700/711C and change the set course by tapping on arrow buttons, by adjusting a slider bar with your finger or the RotoKey™, or by dragging the course arrow with your finger.

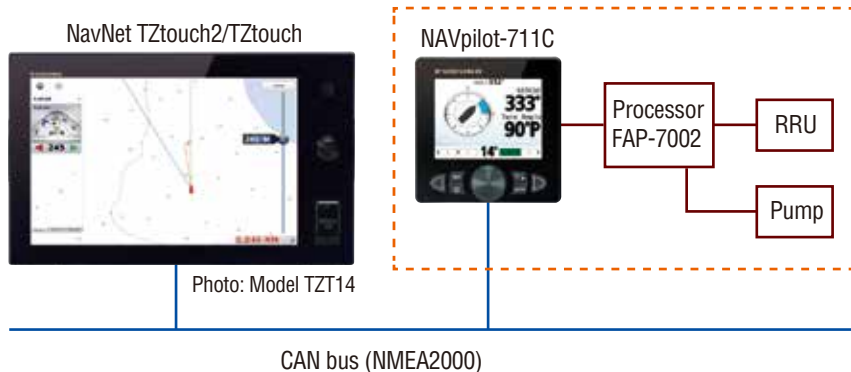

## SAIL BOAT

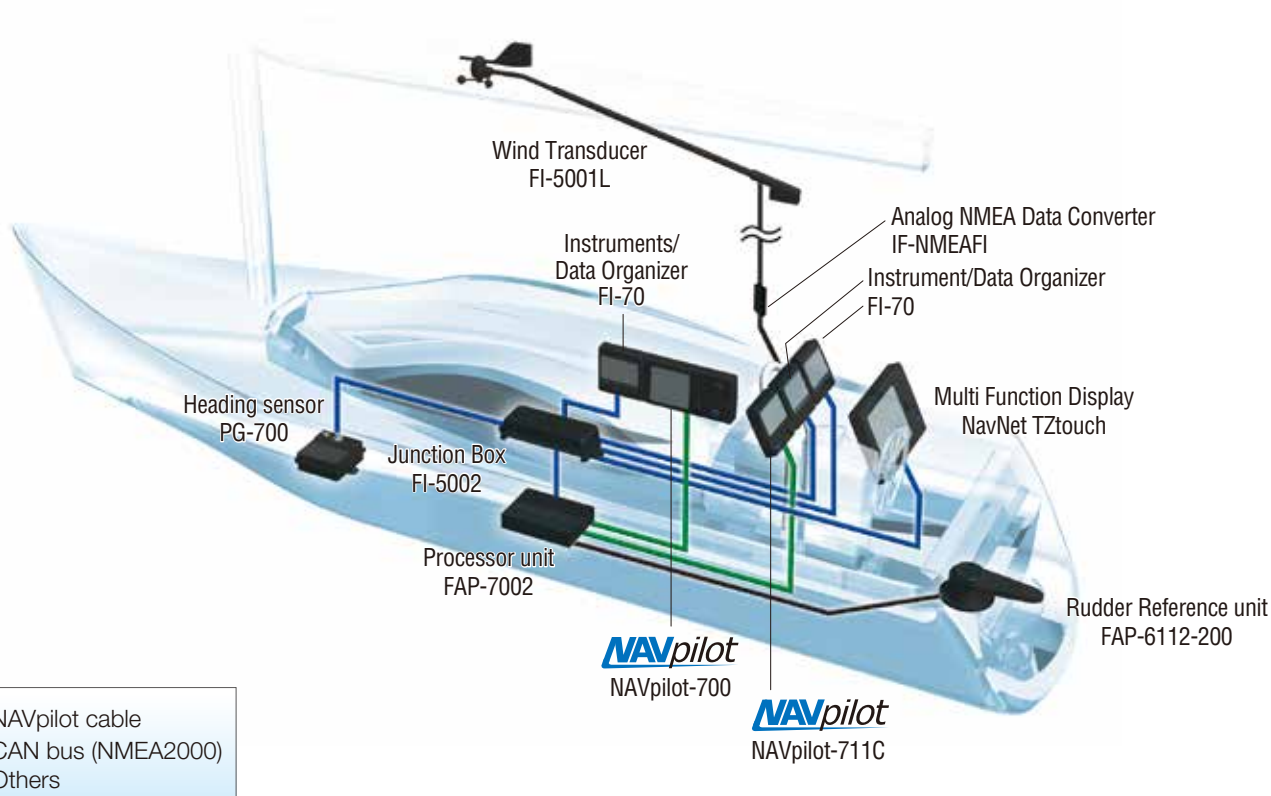

# SPECIFICATIONS

NAVipilot-700

NAVipilot-711C

CONTROL UNIT			
Display		4.6" Monochrome LCD	4.1" Color LCD
Effective Display Area		85.2 (W) x 85.2 (H) mm	82.6 (W) x 61.9 (H) mm
Pixel Number		160 x 160 dots	320 x 240 dots
Backlight			8 steps
Contrast		16 steps	-
PROCESSOR UNIT			
Rudder Angle Adjustment		STBY, Auto, Dodge, Turn, Remote, Advanced auto*, Navigation*, Wind*, Fish Hunter™* * external data required	
Sea Condition Adjustment		AUTO/MANUAL-CALM/MODERATE/ROUGH	
Rudder Angle Settings		10 - 45 deg	
Alarm		Heading deviation, Cross-track error*, Ship's speed*, Depth*, Water temperature*, Wind*, Watch, Log trip*, * external data required	
INTERFACE			
Ports		CAN bus (NMEA2000) : 1, NMEA0183: 2	
Input		(NMEA0183) AAM, APB, BOD, BWC, BWR, DBT, DPT, GGA, GLL, GNS, HDG, HDM, HDT, MTW, MWV, ROT, RMB, RMC, THS, TLL, VHW, VTG, VWR, VWT, XTE, ZDA (CAN bus) 059392/904, 060928, 061184, 126208/720/992/996, 127250/251/258/488/489, 128259/267, 129025/026/029/033/283/284/285, 130306/310/311/312/313/314/577/818/821/827/880	
Output		(NMEA0183) DBT, DPT, GGA, GLL, GNS, HDG, HDM, HDT, MTW, MWV, RMB, RMC, ROT, RSA, VHW, VTG, VWR, VWT, ZDA (CAN bus) 059392/904, 060928, 061184, 126208/464/720/992/996, 127237, 245/250/251/258, 128259/267, 129025/026/029/033/283/284/285, 130306/310/311/312/822/823	
ENVIRONMENT			
Temperature		-15°C to +55°C	
Waterproofing	Processor unit	IP20	
	Other unit	IP56	
POWER SUPPLY			
		12-24 VDC: 4.0 - 2.0 A (excluding pump)	
EQUIPMENT LIST			
Standard		Control Unit (FAP-7001 or 7011C), Processor Unit FAP-7002, Installation Materials and Spare Parts	
Options		Control Units, Flush Mount Kits, Bracket-mount Kits, Cradle, Rudder Reference Units FAP6112-200, Remote Controllers, Cables, Connectors, Junction Box, Pump Unit, FPS8 Power Steering Module, Volvo Interface Kit FAP-6300	

## NAVipilot-700 Control Unit (Bracket-mount) FAP-7001 0.9 kg 1.9 lb

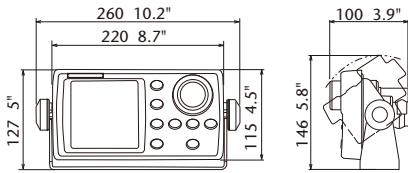

## NAVipilot-711C Control Unit (Surface-mount only) 0.33 kg 0.7 lb

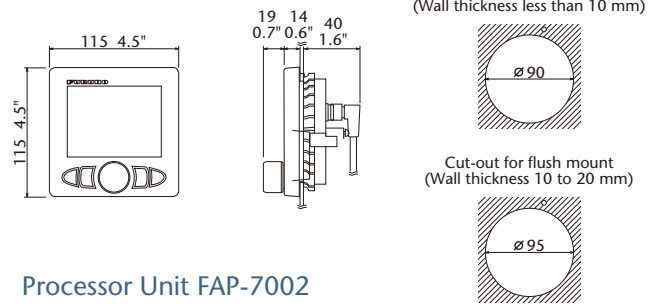

## NAVipilot-700 Control Unit (Surface-mount) 0.62 kg 1.4 lb

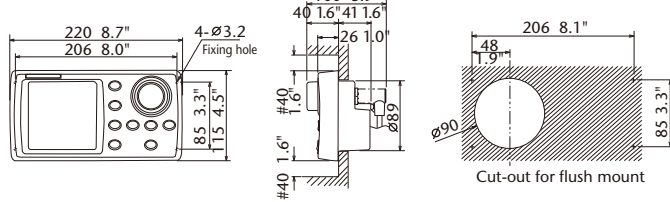

## Processor Unit FAP-7002 1.9 kg 4.2 lb

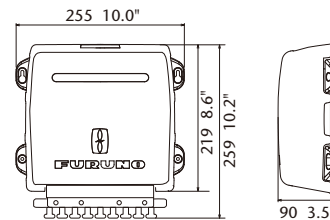

## NAVipilot-700 Control Unit (Flush-mount) 0.64 kg 1.4 lb

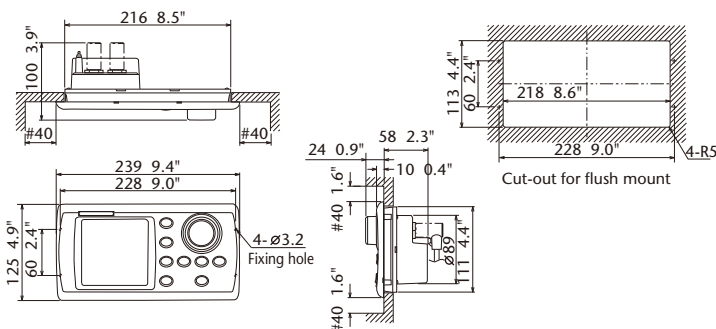

<http://www.furuno.com/special/en/navipilot/>  
Visit our website to watch guided videos, see screenshots and learn more about features of NAVipilot-700 series.



All brand and product names are registered trademarks, trademarks or service marks of their respective holders.

**SPECIFICATIONS SUBJECT TO CHANGE WITHOUT NOTICE**

### FURUNO ELECTRIC CO., LTD.

Nishinomiya, Hyogo, Japan  
www.furuno.com

### FURUNO U.S.A., INC.

Camas, Washington, U.S.A.  
www.furunousa.com

### FURUNO (UK) LIMITED

Havant, Hampshire, U.K.  
www.furuno.co.uk

### FURUNO FRANCE S.A.S.

Bordeaux-Mérignac, France  
www.furuno.fr

### FURUNO ITALIA S.R.L.

Gatteo Mare, Italy  
www.furuno.it

### FURUNO ESPAÑA S.A.

Madrid, Spain  
www.furuno.es

### FURUNO DANMARK A/S

Hvidovre, Denmark  
www.furuno.dk

### FURUNO NORGE A/S

Ålesund, Norway  
www.furuno.no

### FURUNO SVERIGE AB

Västra Frölunda, Sweden  
www.furuno.se

### FURUNO FINLAND OY

Espoo, Finland  
www.furuno.fi

### FURUNO POLSKA Sp. z o.o.

Gdynia, Poland  
www.furuno.pl

### FURUNO EURUS LLC

St. Petersburg, Russian Federation  
www.furuno.com.ru

### RICO (PTE) LTD

Singapore  
www.rico.com.sg

### FURUNO DEUTSCHLAND GmbH

Rellingen, Germany  
www.furuno.de

### FURUNO HELLAS S.A.

Piraeus, Greece  
www.furuno.gr

### FURUNO (CYPRUS) LTD

Limassol, Cyprus  
www.furuno.com.cy

### FURUNO SHANGHAI CO., LTD.

Shanghai, China  
www.furuno.com/cn