

SEA.AI 

SENTRY INSTALLATION MANUAL

Version: 2.0

SEA.AI Group

SEA.AI GmbH

Siemensstrasse 60
4030 Linz
AUSTRIA

SEA.AI GmbH

Taborstrasse 20
1020 Vienna
AUSTRIA

SEA.AI Lda

Rua António Champalimaud
Lote 1, Piso 1, Sala 1.13B,
1600-514 Lisbon
PORTUGAL

SEA.AI SAS

Port La Forêt
29940 La Forêt
Fouesnant
FRANCE

SEA.AI Inc.

407 Lincoln Road, Suite
10F Miami Beach, FL
33139
USA

Contents

1	Introduction.....	3
1.1.	System overview and Specifications.....	3
1.2.	Product Registration.....	4
1.3.	Parts Included.....	4
	Needed Tools.....	4
2	Installation.....	5
2.1.	Mounting Guidelines.....	5
2.2.	Clearance.....	6
2.3.	Mounting and Hole Pattern.....	7
	Fixation with Adapter Plate (screwing from above).....	7
	Fixation without Adapter Plate (screwing from below).....	8
3	Wiring.....	9
3.1.	Guidelines.....	9
3.2.	Wiring Diagram.....	9
3.3.	Sentry Hybrid Cable.....	10
3.4.	Power Connection.....	11
3.5.	Data Connection.....	12
	Network Information.....	12
	NMEA 2000 / NMEA 0183 Gateway.....	12
4	Control Devices and Clients.....	13
4.1.	MFD Connection.....	14
5	System Set up.....	15
5.1.	First start up.....	15
5.2.	Set Boat Parameter.....	16
5.3.	Boat structure ignore-mask.....	16
	Camera Mask Setup.....	16
	mask.tiff file.....	17
	Upload and check ignore mask.....	18
5.4.	System Update.....	18
5.5.	Set-Up shortcut to start UI in full screen.....	18
6	Technical Drawings.....	19
7	Maintenance, Warranty and Support.....	20

1 Introduction

1.1. System overview and Specifications



Sentry Specifications	
Thermal Camera Long Range	Boson® 640 x 512px, 8° HFOV, 50 mm lens
Thermal Camera Close Range	Boson® 640 x 512px, 32° HFOV, 14 mm lens
Lowlight Camera Long Range	2560x1944px, 34° HFOV, 8 mm lens
Lowlight Camera Close Range	2560x1944px, 8° HFOV, 35 mm lens
Pan, Tilt	360°, +/- 20°
Interface Compatibility	iPad, Windows, Mac, Linux
Dimensions (LxWxH)	366mm x 232mm x 202mm
Weight	5.4 kg
Power Consumption	24V DC 6A, Average: 50W -70W

1.2. Product Registration

SEA.AI systems rely on occasional updates for continuous reliable operation. You must therefore register your new system online before starting it. Follow the instructions on www.sea.ai/start-sentry to initialize Sentry and ensure its full productivity.

Note: Product needs to be registered before first start up.

1.3. Parts Included

- SEA.AI Sentry unit

- Installation Kit Sentry
 - Sentry Hybrid Cable with D-sub connector and sealing
 - DC-DC Converter 24/24-12 280W
 - 4x Sentry Screws (1/4" - 20 UNC)
 - Adapter Plate
 - RJ45 Coupler (IP68)
 - Spare Fuse (4A Ceramic Cartridge Fuse, 5 x 20mm, Speed FF)

Needed Tools

- Allen key 5/32" or 4 mm
- Flat head screwdriver
- Power drill + drill bit or screw tap
- Pen, ruler, etc.
- Mounting screws if "Adapter Plate" will be used (see chapter "Mounting and Hole Pattern" on page 7)

2 Installation

2.1. Mounting Guidelines

Ensure a mounting position with a field of view as unobstructed as possible.

Any obstruction from boat structure, antennas, radars, flags etc. will decrease Sentry's Field of View and thus its performance.

Mount Sentry as high as possible on a stable and rigid support.

The higher the unit will be installed the further the camera can detect objects and the better predict distances.

Avoid hot surfaces (e.g., exhaust pipe) in the direct Field of View to not interfere with the thermal detection.

Avoid a mounting position with strong vibrations (i.e., due to transmitted engine vibrations).

Do not tilt or turn the Sentry unit by hand.

Mount Sentry only in upright position on a flat and horizontal surface.

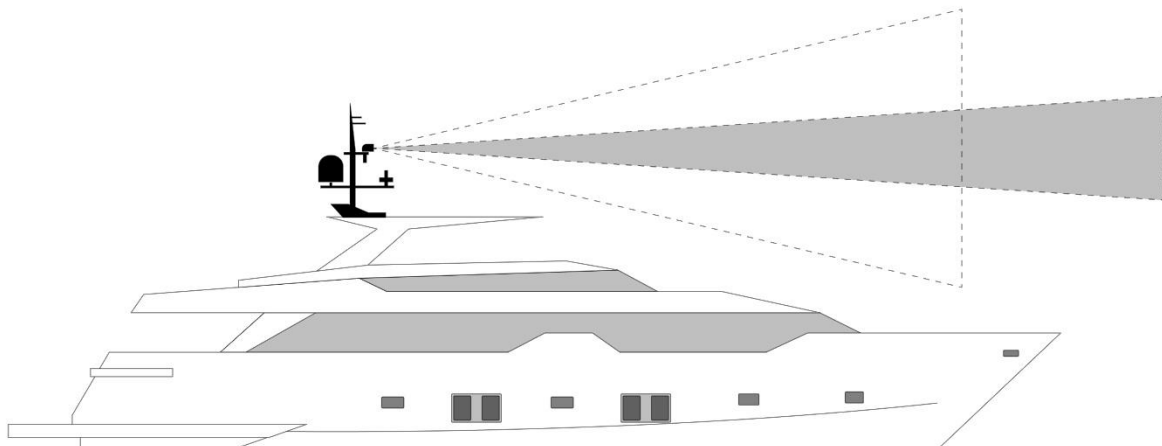

2.2. Clearance

The minimum required clearance for movement is a cylinder of $\varnothing 420$ mm x 235 mm around the rotation axis and measured from the bottom base surface of the unit.

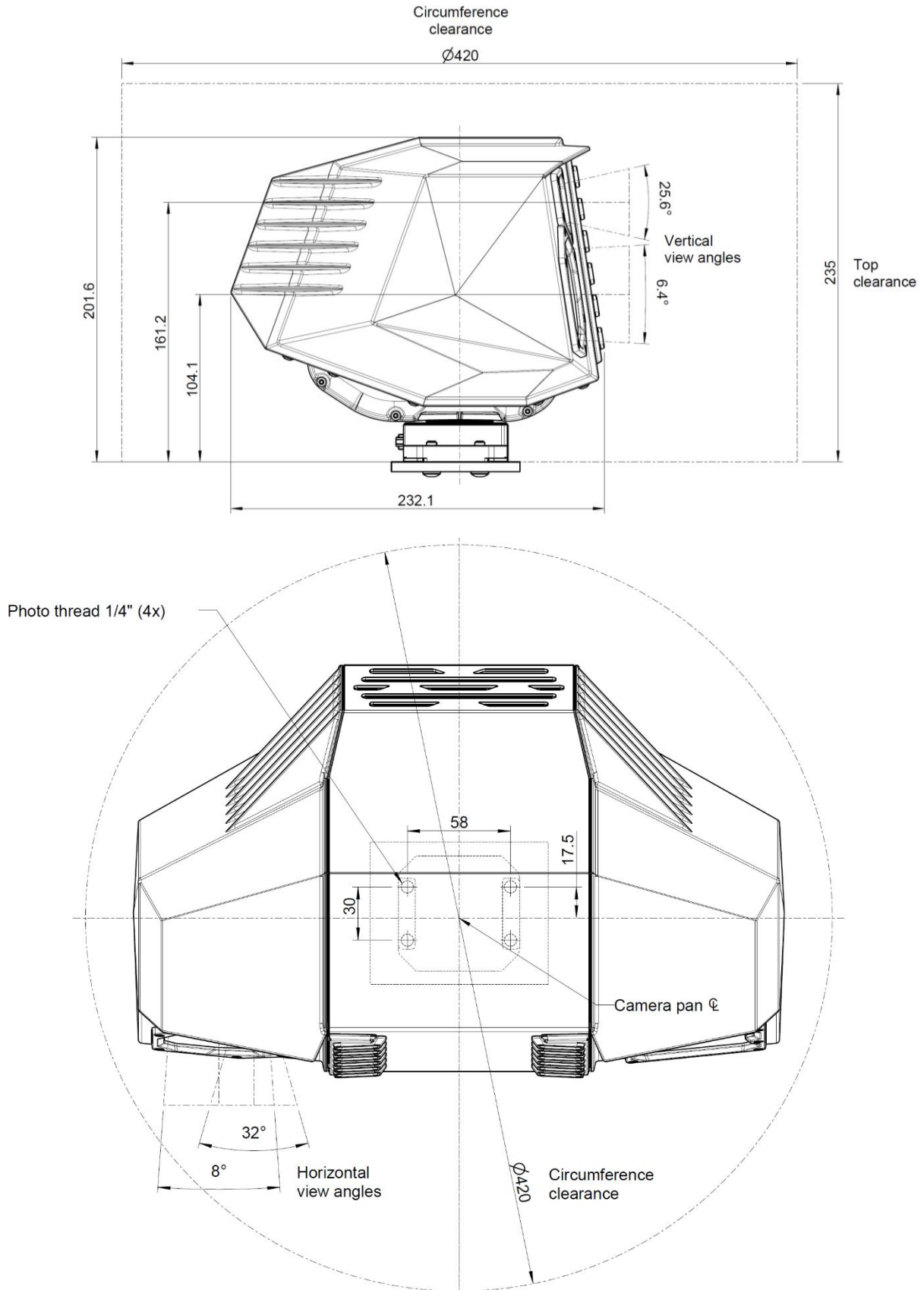

2.3. Mounting and Hole Pattern

SEA.AI Sentry can be mounted with either the supplied screws from below or with the special adapter plate from top.

Fixation with Adapter Plate (screwing from above)

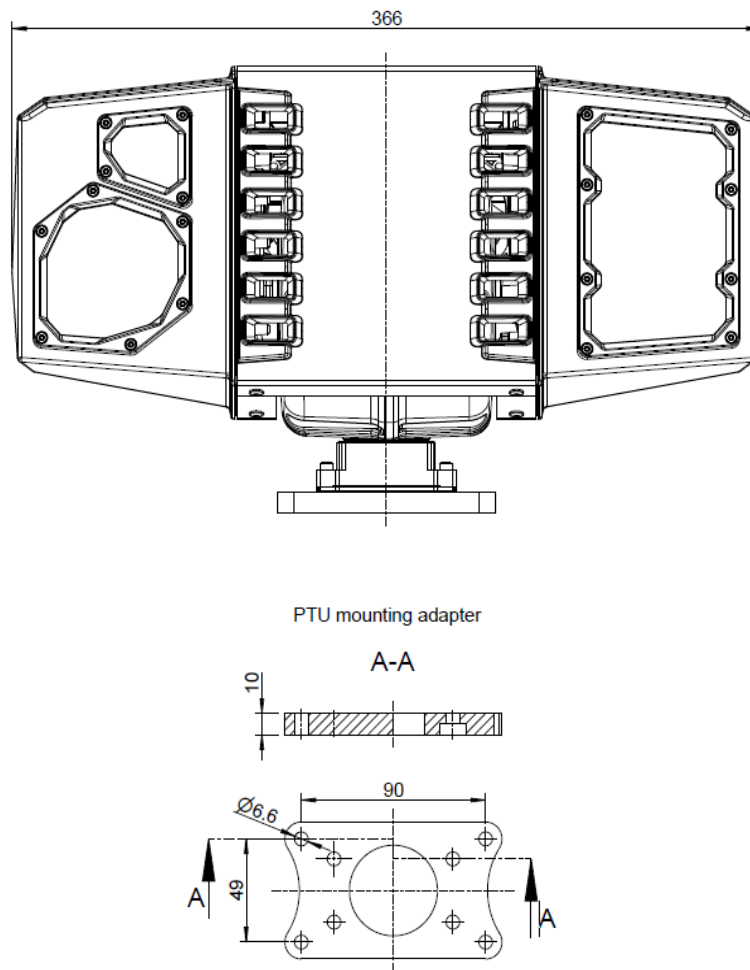

Note: Screws for mounting the adapter plate to the boat are not part of the installation kit.

Fixation without Adapter Plate (screwing from below)

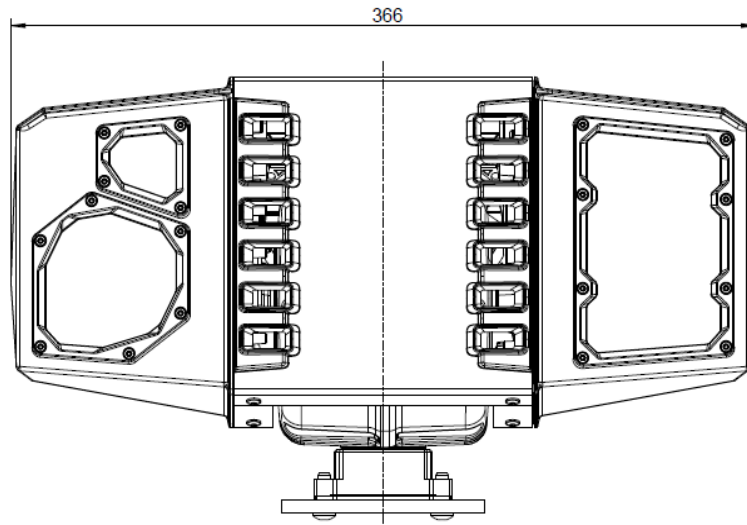

Mounting template

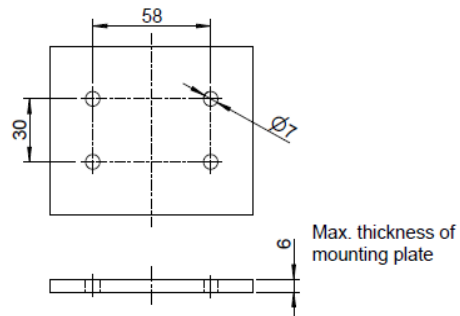

Note: Sentry screws (1/4" - 20 UNC) supplied in the installation kit, allow a maximum thickness of 6 mm for the counter mounting plate.

3 Wiring

3.1. Wiring Guidelines

- Avoid kinking or over-bending the cables and do not route cables over sharp edges or burrs.
- Prevent excessive tension on the cables and connectors by using adequate strain relief.
- Avoid installing cables in such a way that water can flow to the connectors.
- Protect cables against any mechanical interference.
- Fix the cables properly and provide servicing and dripping loops.
- Leave enough space next to the connectors to ensure easy connection and disconnection of cables.
- Use a dedicated circuit breaker and fuse for Sentry.

Warning: Wrong polarity can damage the system! Ensure power is off before starting the installation!

3.2. Wiring Diagram

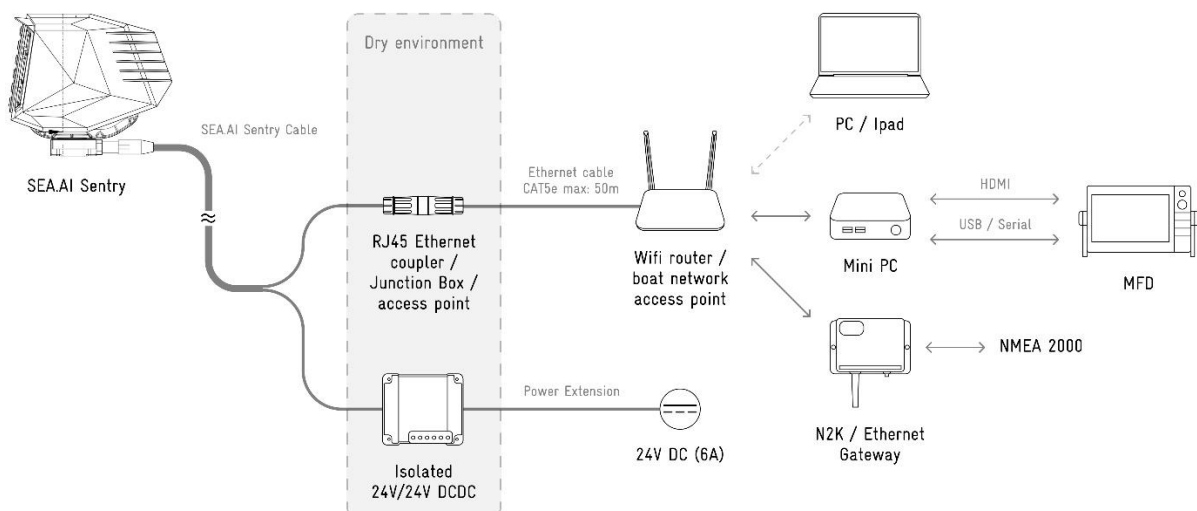

3.3. Sentry Hybrid Cable

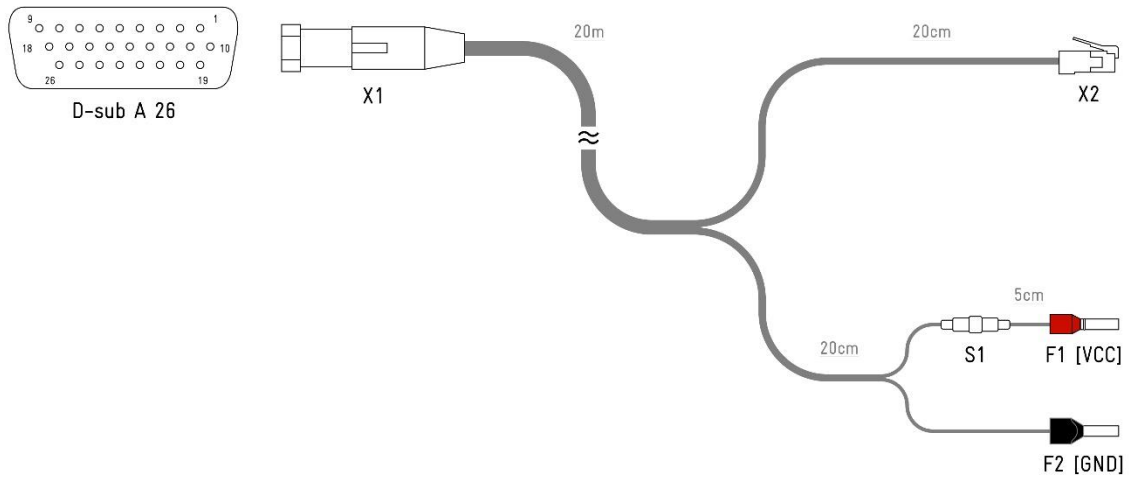

X1 (D-Sub connector Pinout)	Pin	Type
	1	Vcc
	2	GND
	3	NC
	4	RS422_BZ
	5	NC
	6	RS422_BZ
	7	BI_DA+
	8	Vcc
	9	NC
	10	Vcc
	11	NC
	12	NC
13	RS422_Y	

Pin	Type
14	RS422_Y
15	BI_DB+
16	BI_DA
17	Vcc
18	GND
19	GND
20	NC
21	RS422_A
22	RS422_BZ
23	RS422_A
24	BI_DB
25	GND
26	GND

X2 (RJ45)	Pin	Colour	Gauge
	1	white	22 AWG
	2	blue	22 AWG
	3	yellow	22 AWG
6	orange	22 AWG	

Power	Pin	Colour	Type
	F1	red	VCC
	F2	blue	GND
S1	-	Fuse	

3.4. Power Connection

SEA.AI Sentry must be powered with 24V DC (6A) and a dedicated circuit breaker or use the remote on/off ports of the DC/DC converter.

Note: Sentry unit does not have an on/off switch.

The isolated 24V-24V DC/DC Converter (part of the installation kit) ensures a stable power supply and prevents from any electrical ground interference. It is highly recommended to connect the DC/DC Converter directly to the Sentry cable. Extension wiring should be done at the converter input side.

See Table below for minimum cross-sections per length to limit excessive voltage drop.

			Extension Wiring before DC/DC converter (Input)				
			2 m	5 m	10 m	20 m	30 m
Sentry Cable	10 m	minimum cross-section	1.5 mm ²	1.5 mm ²	1.5 mm ²	2.5 mm ²	4 mm ²
	20 m		1.5 mm ²	1.5 mm ²	1.5 mm ²	2.5 mm ²	4 mm ²

			Extension Wiring after DC/DC converter (Output)				
			2 m	5 m	10 m	20 m	30 m
Sentry Cable	10 m	minimum cross-section	1.5 mm ²	1.5 mm ²	2.5 mm ²	6 mm ²	10 mm ²
	20 m		1.5 mm ²	4 mm ²	10 mm ²	16 mm ²	16 mm ²

3.5. Data Connection

SEA.AI Sentry sends and receives data via Ethernet in a local area network.

SEA.AI Sentry must be connected to a suitable local area network (LAN) either directly via an Ethernet cable connection or via a Wi-Fi router. The Sentry Hybrid Cable can either be connected directly into a switch/router or extended with an Ethernet patch cable (min. CAT5e) by using the supplied network cable connector.

Attention: For undisturbed operation, Sentry requires minimum 100 BASE-T (100 Mbit/s bandwidth) connection.

Network Information

Access: <http://oscar.local/> or <http://192.168.1.191/develop/main.html>

Fixed IP: 192.168.1.191 Gateway: 192.168.1.1

NMEA 2000 / NMEA 0183 Gateway

To read additional boat information from marine sensors (e.g., speed, GPS-position, heading, etc.) via SEA.AI Sentry's Ethernet port, the boat bus information needs to be available on the LAN or Wi-Fi network via TCP/IP or UDP protocol.

Note: SEA.AI Sentry main functionality is a fully independent from any additional sensor and can be used without NMEA2000 or NMEA0183 integration. However, it is recommended to connect SEA.AI Sentry with an Ethernet/Wi-Fi – Ethernet Gateway. Upcoming features with occasional software updates may rely on boat bus information and can increase SEA.AI Sentry's accuracy and performance.

4 Control Devices and Clients

To run the SEA.AI Sentry user interface (UI) and thus control the unit, a suitable control device, such as a PC or tablet, must be connected to the same local network as Sentry.

Compatible devices and minimum hardware requirements see below.

Note: It is only possible to control Sentry via the UI with one client at the same time. In case an additional client wants to access the user interface simultaneously a message "Connection busy" will appear if the first client is accessing the Sentry UI.

Minimum PC Requirements

OS:	Windows 10/11, Linux
Browser:	Google Chrome Web browser (105 or higher)
CPU:	Intel i3 (8th generation) or better
RAM:	4GB DDR4
Ports/Interfaces:	HDMI, USB 3.0, Gigabit Ethernet LAN, Audio out interface
Screen:	Min. resolution: 1180x820px or higher
Interfaces:	Touch or mouse and keyboard

Supported Tablets

iPad	7th generation or higher
iPad Pro 12.9	3rd generation or higher
iPad Pro 11	1st generation or higher

4.1. MFD Connection

Selected MFDs support remote control of a connected PC running the Sentry UI via the MFDs touchscreen. (See table of most common MFDs below**)

Please check our ["Online Documentation"](#) under section "Installation – MFD Monitor Mode" or the MFDs manual for further details.

MFDs supporting monitor / remote mode **	
Garmin	84xx series (MFD series)
Raymarine	Axiom XL series
Furuno	- TZT16F - TZT19F - TZT2BB
Simrad	NSO series

** Table with no guarantee of completeness

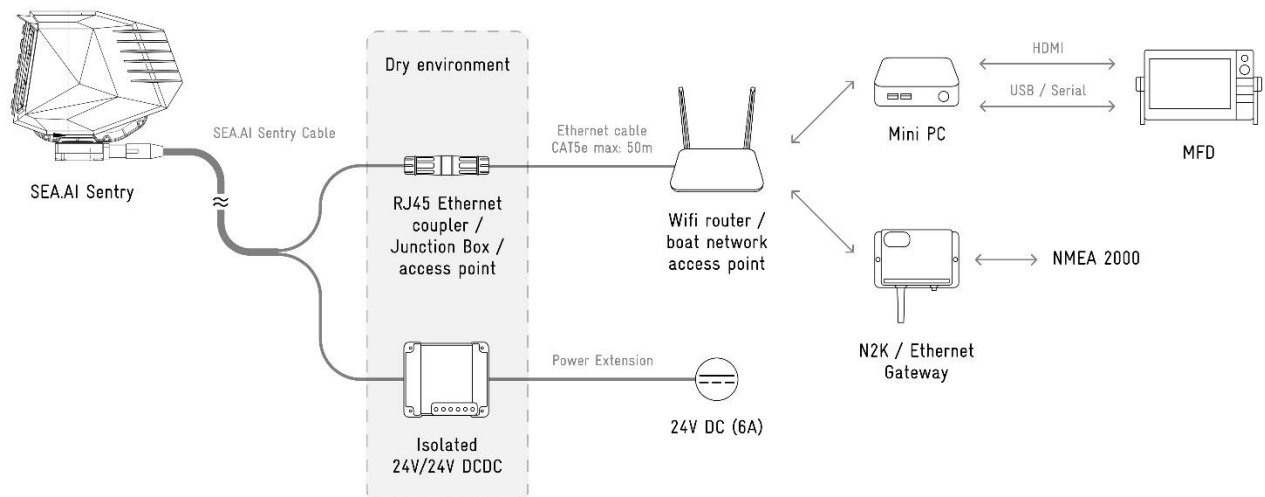

5 System Set up

5.1. First start up

Power Sentry by switching on the dedicated Sentry circuit breaker described in Chapter "on page "8".

Warning: SEA.AI Sentry must be able to freely rotate 360° and tilt +/- 20° in every direction before powering the system. Any obstruction or blocking the movement will damage the system!

Note: Booting up the system and loading the SEA.AI software and database can take up to 3 minutes! The user interface is only available after start-up has been completed.

Power and start up all necessary accessories such as PC or tablet and its interfaces (screen, MFD, trackball, keyboard etc.).

Open Sentry UI via the browser (Google Chrome recommended):

<http://oscar.local/>

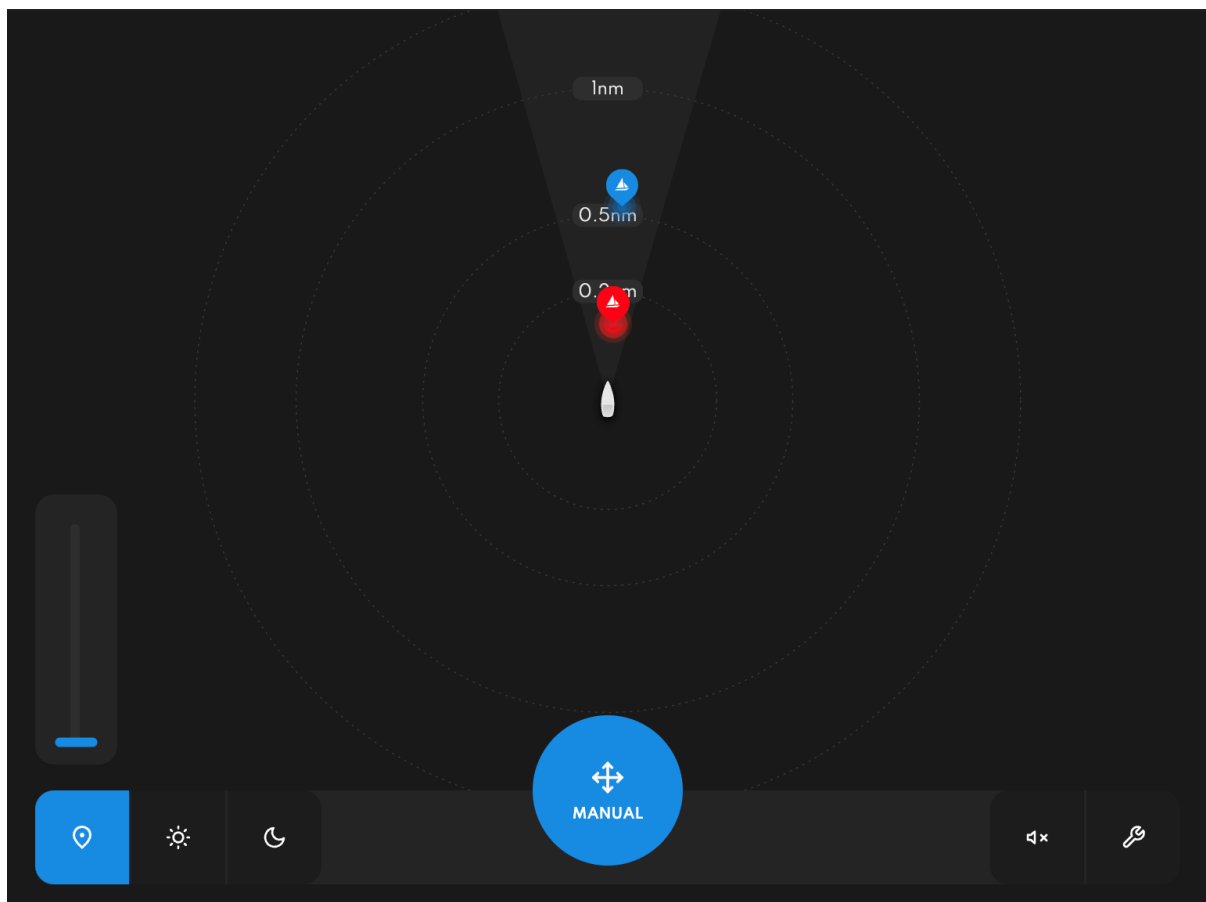

5.2. Set Boat Parameter

For an optimal alarming functionality and accurate distance estimation setting the exact parameter of mounting height and the distance from the unit to the bow are necessary.

Note: Mounting height is the distance in meters between the water surface and the bottom base of the Sentry unit.

To set the parameter, open the settings page by clicking on the settings icon in the bottom right corner  and open the Installation sub-menu and log in as an Installer.

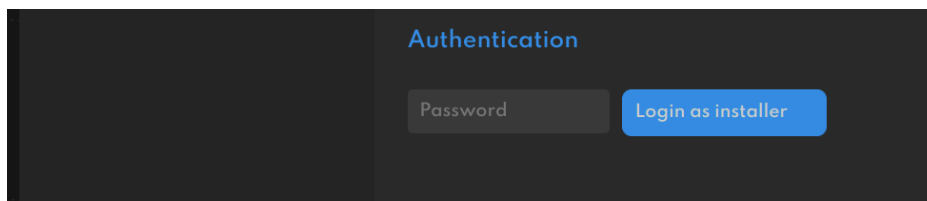

Password: oscarinstaller

Set the parameters:

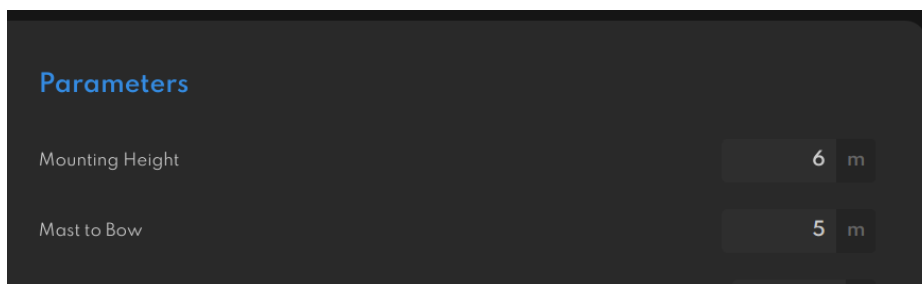

5.3. Boat structure ignore-mask

SEA.AI Sentry offers a 360° view with +/-20° tilt function. To avoid false detections from any boat structure or equipment, an ignore-mask must be created to learn which areas must be excluded from SEA.AI.

Camera Mask Setup

The system creates a 360° x 65° panoramic image from all pan and tilt positions by running a "Camera Mask Diagnostic" which will later be used for creating the boat structure ignore mask.

Warning: The "Camera Mask Diagnostic" takes about 20 minutes. Do not touch or close the application or power off the system.

Important Note: Run the "Camera Mask Diagnostic" outside of the harbour to ensure as little background in the panorama image.

After finishing the camera mask diagnoses, a download button will appear to save the "Panorama_image_full.tiff" file on the used device.

mask.tiff file

The mask.tiff file is an edited black and white image mask based on the created panorama image, where all black areas mark the locations to be ignored (e.g., boat structure, equipment, etc.) and all white areas location the input for the SEA.AI neural network.

SEA.AI Service Team offers a free service to create the ignore mask.

SERVICE OPTION:

Receive mask.tiff file from SEA.AI Service Team.

To do that just send the downloaded panoramic image to service@sea.ai and receive the mask.tiff file back.

Note: Please align with SEA.AI Service Team in advance to receive the file back as quick as possible.

Of course, the mask.tiff file can also be self-created by using a drawing program like Gimp, Paint or Photoshop.

SELF-CREATION OPTION:

- Copy the downloaded Panorama_image_full.tiff" file and rename it to mask.tiff
- Open mask.tiff in a drawing program (e.g, Gimp)

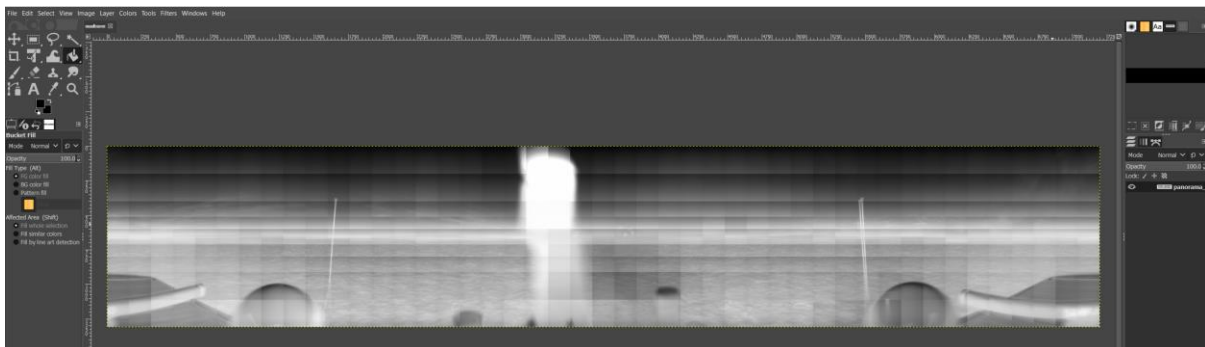

- Mark all areas which should be ignored and colour it black.
 - Use free-hand-selecting tool (F) for boat shape and press enter
 - Tip:** Add another selection area by holding "shift" and select an additional area
 - Cut out the selection (Ctrl+X or delete)
 - Paint the selection black by using the bucket tool (Shift+B) with black colour
 - Invert the selection (Ctrl+I) to pick the area with no obstruction in the view
 - Cut out the inverted selection (Ctrl+X or delete)
 - Use the bucket tool (Shit+B), change to white and paint the selected area all in white.
- Safe this as mask.tiff

Upload and check ignore mask

Select the mask.tiff file (sent by SEA.AI Service Team or self-created) and press “Upload” in the Installation sub-menu in the Sentry UI.

- Restart the system
- Turn on the displaying of the mask by checking “Display Camera Mask on screen”
- Check the ignored areas in the thermal cam view and undisplay the mask again

Warning: An improper mask can lead to false detection or decreased performance. Please redo the mask or contact service@sea.ai.

5.4. System Update

Download the latest Sentry OS Update Package [here](#) and select the file under “Settings – Sentry OS – System Update”

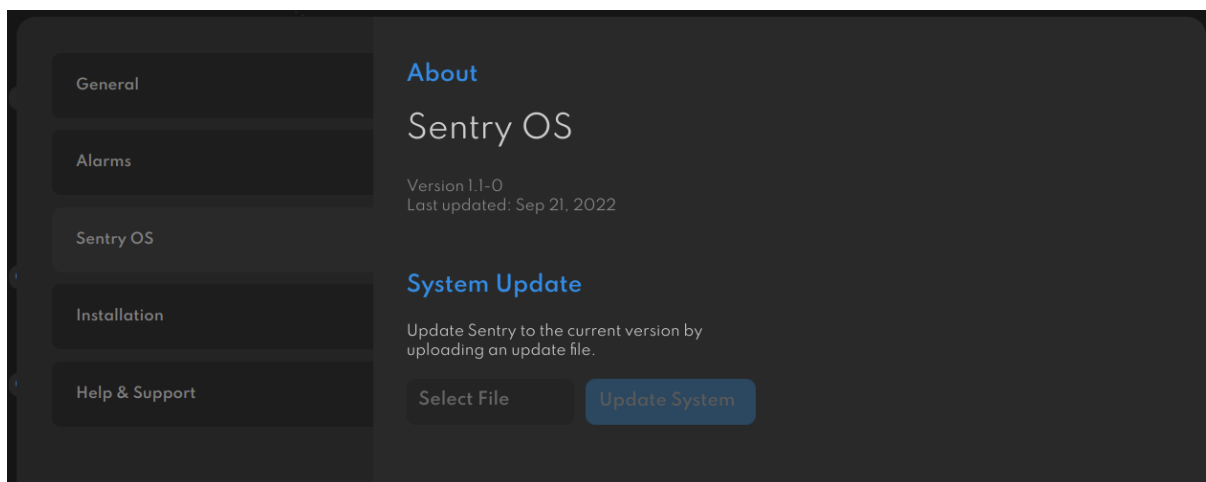

5.5. Set-Up shortcut to start UI in full screen

- Open SEA.AI Sentry UI in the Browser (Google Chrome recommended) via <http://oscar.local/>
- Go to “customize and control” in the right upper corner 
- Click “More tools”
- “Create shortcut” and tick “Open as window”
- Close the browser and open the Sentry app via the icon created at the desktop

6 Technical Drawings

Please find all technical drawings in the [Sentry Online Documentation](#) under section Drawing.

7 Maintenance

The system shall always run the latest available software.

Updating your software will frequently provide feature- and performance enhancements.

The camera housing and lens will require occasional cleaning. Clean the lens when image quality degradation is noticed, or excessive dirt build up is seen.

Important when cleaning this product:

Do NOT wipe the lens windows with a dry cloth, or with abrasive materials such as paper or scrub brushes, as this could scratch the coating.

Do NOT use acid or ammonia-based products.

Do NOT pressure wash.

Care should be taken when cleaning the lens windows, this has a protective anti-reflective coating which may be damaged by improper cleaning.

Rinse the camera lenses with fresh water to remove all dirt particles and salt deposits. Clean the vision unit body with a clean, soft cotton cloth. You can moisten the cloth and use a mild detergent if required. Allow to dry naturally.

If any spots or smears remain, gently wipe the lens window with a clean microfibre cloth or soft cotton cloth.

If necessary, use isopropyl alcohol (IPA) or a mild detergent to remove any remaining spots or marks.