

**FURUNO**

**12.1" COLOR LCD DISPLAY  
SEARCHLIGHT SONAR**

Model **CH-500**

(Frequency 60/88/150/180/240 kHz)

*Unmatched training speeds  
High resolution echoes*

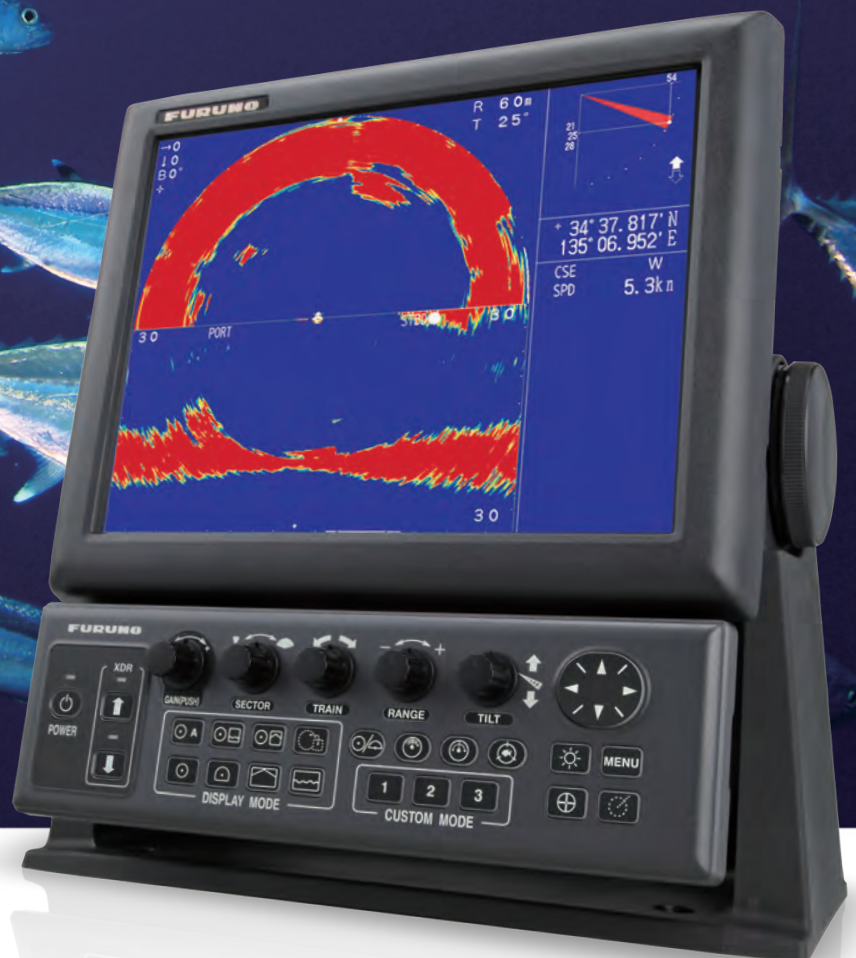

More details on  
[www.furuno.com](http://www.furuno.com)



# 12.1" COLOR LCD DISPLAY SEARCHLIGHT SONAR

Model **CH-500**



## Higher resolution due to Advanced signal processing

Powerful signal and image processing techniques, based on a unique interpolation technology, provides images in very high resolution. Even if the fish are located near the seabed, the different echoes are clearly shown and easy to understand. The higher resolution display yields a presentation that is crisp and clear.

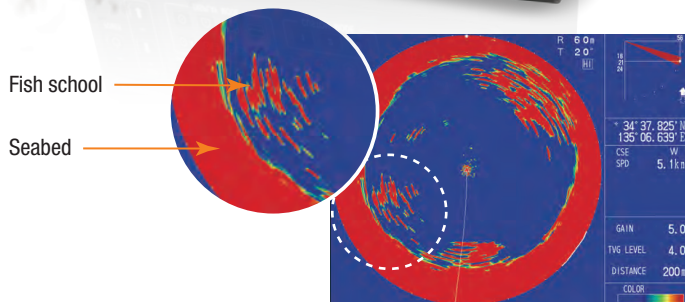

## Reverberation reduction

The reverberation reduction offers better understanding and a better appreciation of the nature of detected echoes. On the right is an example of how the reverberation reduction function highlights the wreck from the surrounding seabed.

\*The echo may be subject to interferences from other Fish Finders  
\*Schools with excessively high density may appear with a weaker echo color

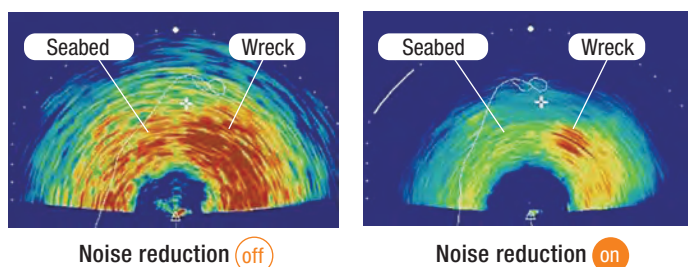

## Quick Gain Control

With the CH-500, the value of the changed gain is instantly applied to the whole circle and all echoes are affected, allowing you to quickly react. With the Quick Gain Control, even in deep areas that slow down the scanning speed, there is no need to wait for the next passage of the searchlight and miss precious information. This new function is also extremely valuable if the fish are moving fast and need to be tracked rapidly.

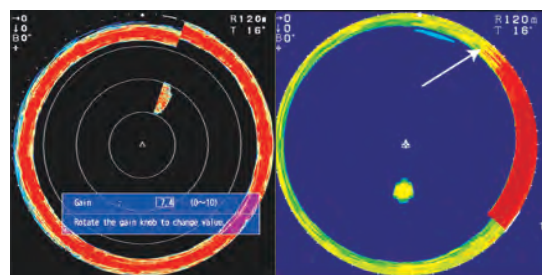

CH-500

Current models

## Audible target detection\*

The CH-500 also features fish and obstacle audio signals depending on the nature and the size of the detected object. Whether there are air bubbles, fish schools or seabed, the emitted sound is unique. It is now easy to differentiate the fish schools from the seabed they are moving next to, allowing for better comprehension of the surrounding environment for more productive fishing. This feature shows its usefulness during long sea trips, as it frees the user from continuously watching the screen.

\*Optional Loudspeaker required

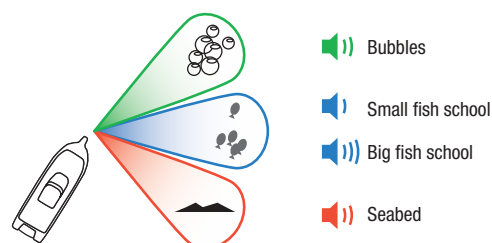

Figure out intuitively what is detected by differentiating their sound with the audible target detection

# Smart features for productive fishing

## ■ Incredibly fast training speeds means less tracking failures

NEW

### ■ Faster motor delivering quicker training speeds

Quick train speeds allow the sonar display to be refreshed at a faster rate, aiding in earlier detection of fish and obstructions.

### ■ 6 step angles for training speed adjustment according to user's needs

The CH-500 sonar is one of the most comprehensive and fastest sonars of its kind. It provides six selectable step variations (6°, 12°, 15°, 18°, 21° or 24°) for high scanning speed that can cover sector widths from 24° to 360° in a couple of seconds. Thanks to its high training speeds, the CH-500 can rapidly scan a large area providing the ultimate fishing and navigational experience.

**Expert tip:** When moving fast, you can use a wider step angle in order to get a glimpse of the surrounding area. If you detect something interesting, slow down and switch to a decreased step angle for clearer echoes.

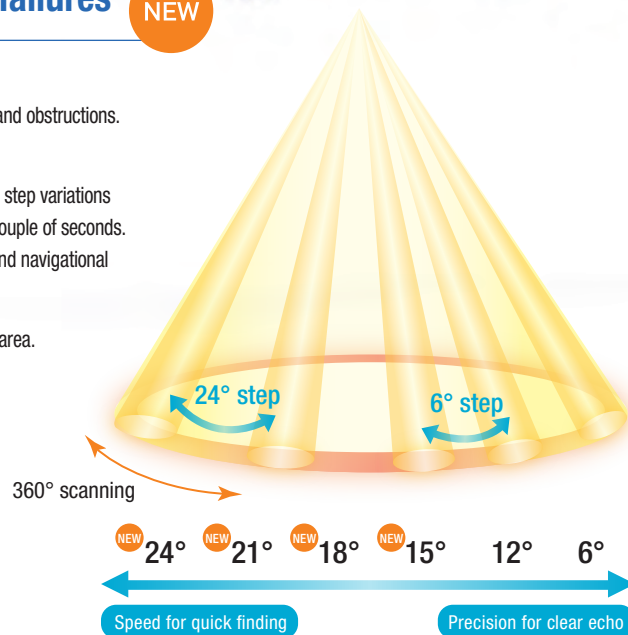
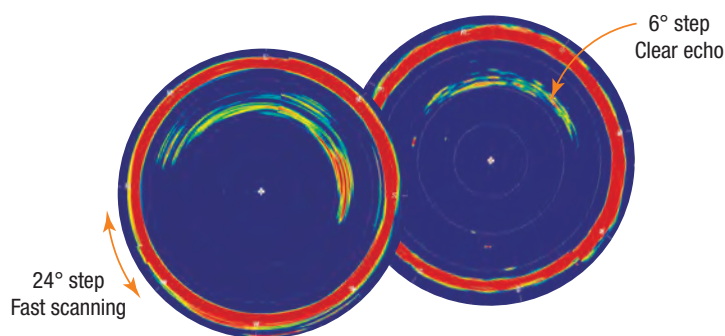

Full Circle Scanning Period(s) in seconds (150kHz)

No.	1	2	3	4	5	6	7	8	9	10	11	12	13	14	15	
Range (m)	10	20	40	60	80	120	160	200	250	300	400	500	600	800	1000	
Step Angle	6°	3.8	3.8	3.8	5.2	6.8	10.1	12.9	16.5	20.6	24.3	32.5	40.5	48.3	64.6	80.5
	15°	3.7	3.7	3.7	3.8	4.8	5.6	7.2	8.4	10.1	12.0	15.0	18.2	21.6	27.8	34.1
	24°	3.7	3.7	3.7	3.7	3.9	4.5	5.8	6.6	7.7	8.8	10.7	12.8	15.0	18.7	22.6

## ■ Built-in motion sensor provides stabilized target presentations in rough sea conditions

The CH-500 searchlight sonar is the first of its class to have integrated motion sensors. In rough seas, vessels tend to move in every direction. This movement can cause inaccurate target information to be displayed. The role of the integrated motion sensors is to precisely compensate for those negative effects and provide accurate data to the user.

**On the picture:** You can see that once the stabilizer is activated, the bottom echo recovers its circular shape. The sonar is then able to provide accurate data even if the vessel is pitching and rolling. Thanks to its integrated motion sensors, the CH-500 is able to detect fish that didn't appear with the non-stabilized echo.

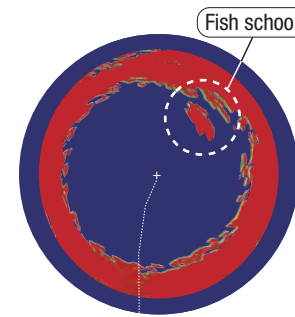
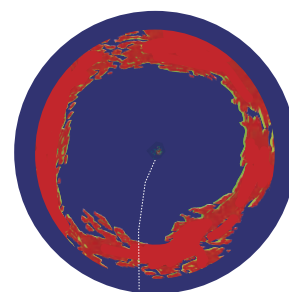

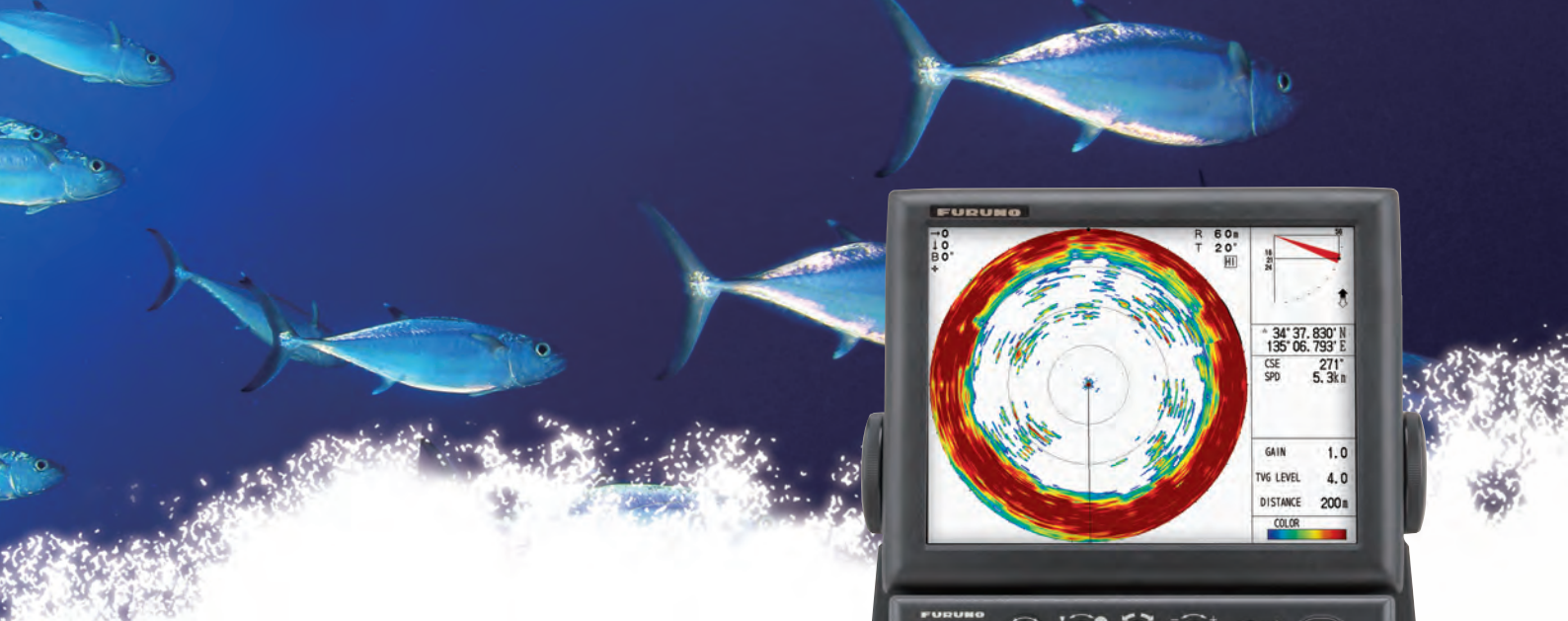

3 different background colors are available for day and night colors (Blue, Black and White)

## Display modes

### Horizontal

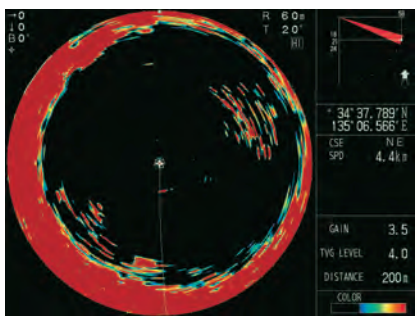

Horizontal scan

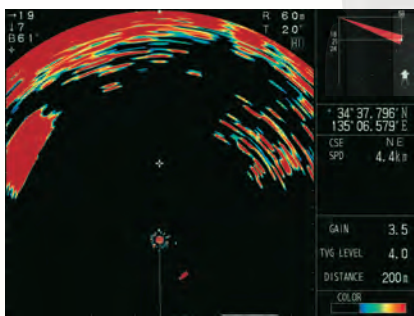

Horizontal scan (zoomed)

A full circle scan (360 degree), provided by a rotating transmitter, detects fish schools around the vessel. (Horizontal scan zoom mode also available)

### Vertical

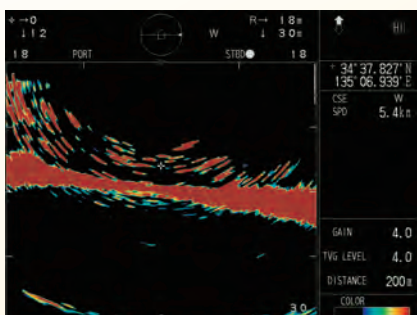

The Vertical scan paints the bottom profile within a user-specified vertical plane in any direction.

### Full-circle A-Scope



The Full-circle A-Scope mode shows the last detected echoes with one single color. The more opaque the color, the stronger the echo. The strength of an echo is clearly shown and it becomes easier to understand the nature of this echo.

### Echo sounder

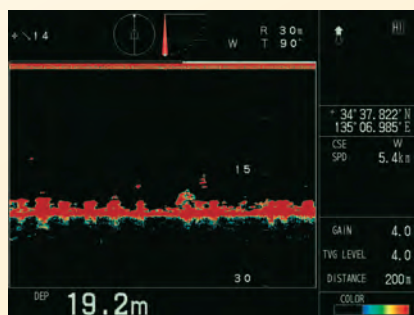

When fully retracted, the vertically tilted transducer can locate fish schools and seabed straight down at high speeds.

# Combination displays

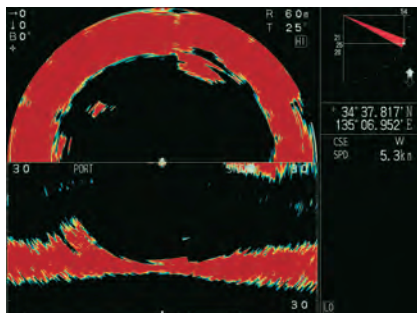

Half-Horizontal + Vertical

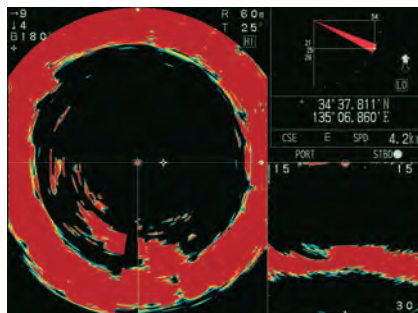

Horizontal + Vertical

## Horizontal + Vertical

A Vertical and a Horizontal scan are displayed in a split screen mode and targets can be tracked in these two dimensions at the same time. It is also possible to choose between Horizontal and Horizontal (zoomed) for the Horizontal scan.

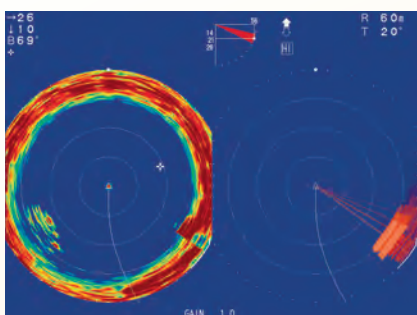

Horizontal + Full-circle A-Scope

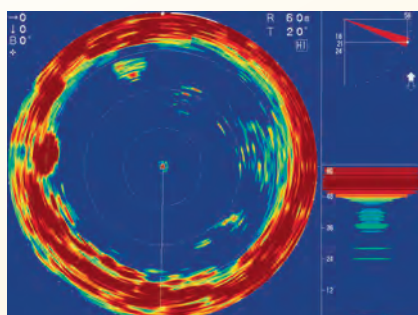

Horizontal + A-Scope

## Horizontal + A-scope

This mode can simultaneously display the Horizontal and the Full-circle A-Scope so that echoes can be analyzed in details with the A-Scope mode, while the Horizontal mode swipes the sea around the ship. It is also possible to choose between two kinds of A-Scope mode: Full-circle A-Scope and A-Scope.

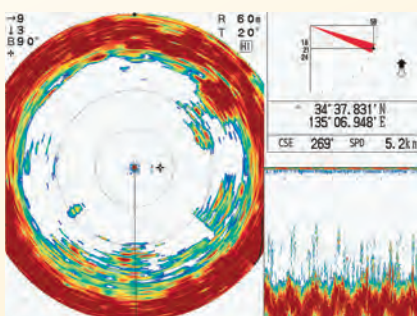

Horizontal + History

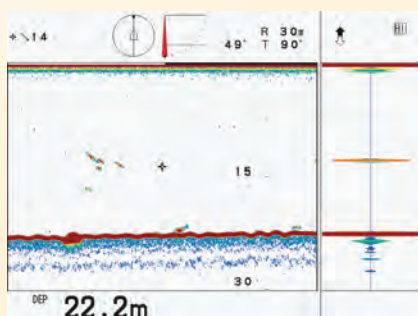

Echo sounder + A-Scope

## Horizontal + History

Horizontal mode combined with a history mode offers the possibility to look at the past data on a vertical plane, while scanning horizontally around the vessel. It is very useful to grasp the movement of the fish and to know if the target is coming closer.

## Echo sounder + A-Scope

To simultaneously display Echo sounder mode and A-Scope mode.

## INTERCONNECTION DIAGRAM

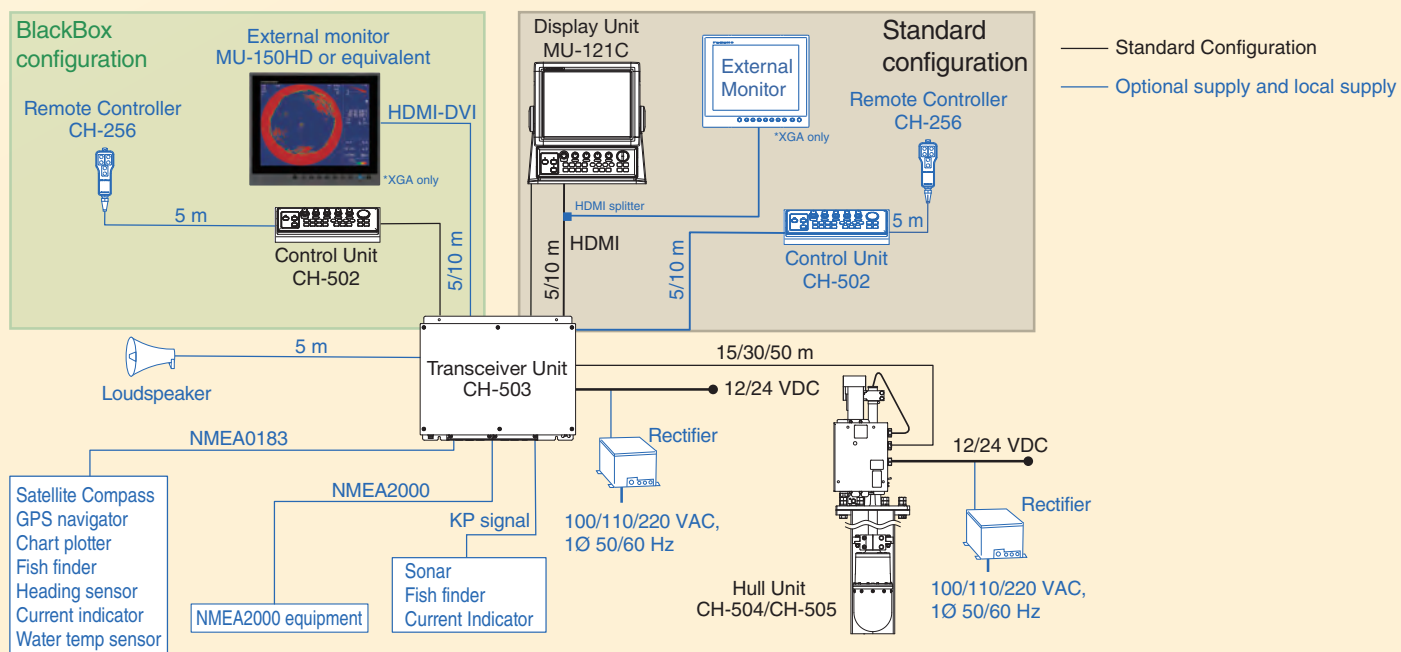

# SPECIFICATIONS OF Model CH-500

Searchlight Sonar

## DISPLAY UNIT

Screen type	12.1 inch color LCD, 1024 x 768 (XGA)
Brightness	0.5 to 950 cd/m <sup>2</sup> (selectable)
Echo color	32, 16 or 8 colors (selectable)
Back-ground color	3 colors (selectable)
Display Mode	1. Horizontal 2. Horizontal (zoomed) 3. Vertical 4. Horizontal/Vertical 5. Horizontal (zoomed)/Vertical 6. Full-circle A-scope 7. Horizontal/Full-circle A-scope 8. Horizontal/A-scope 9. Echo sounder 10. Echo sounder/A-scope 11. Horizontal/History
Echo information	Range, Sensitivity, TVG, Tilt angle, Interference rejection
Sensor information	L/L (own ship or cursor), Depth, Bearing, Ship's speed, Track, Water current vector, Water temperature (external data required)
Indication unit	Meter, feet, fathom, pb, HIRO
Language	English, Thai, Vietnamese, Chinese, Spanish, Indonesian, Malay, Burmese, French, Norwegian, Italian, Greek, Japanese

## TRANSCIVER UNIT

Frequency	60/88/150/180/240 kHz, selected
Output power	0.8 kW to 1.5 kW (depending on frequency), power reduction function available
Pulse length	0.2 to 20.0 ms, according to range
TVG	Level: 100 dB max, Distance: 1000 m max.
Range	Horizontal: 10 to 2400 m, 15 steps Vertical: 10 to 600 m, 15 steps
Audio output	2 W (8 ohms), Frequency 0.9 to 1.2 kHz (external speaker required)

## HULL UNIT

Transducer travel	400 mm or 250 mm
Raise/lower time	30 s at 400 mm travel, 20 s at 250 mm travel
Allowable ship's speed	20 kn or less (15 kn during raise/lower operation)
Horizontal mode control	Scanning angle 6° to 360°, 24° step Scanning center 6° steps, 360° setting available Scanning speed (step angle) 6°, 12°, 15°, 18°, 21°, 24° Tilt angle -5° to +90° (vertical), 1° step
Vertical mode control	Scanning angle 6° to 180°, 12° step Scanning center 0° to 180°, 6° step Scanning step angle Normal: 3°, high-speed: 6°
Transceiver beam with (Frequency -3 dB/-6 dB)	60 kHz : horizontal : 15°/20° vertical : 12°/17° 88 kHz : horizontal : 12°/16° vertical : 10°/13° 150 kHz : horizontal : 7°/9° vertical : 7°/9° 180 kHz : horizontal : 7°/9° vertical : 8°/10° 240 kHz : horizontal : 6°/8° vertical : 6°/8°
Stabilization	Built-in motion sensor (standard supply)

## INTERFACE

Number of ports	Video signal output: 1 port, HDMI, XGA NMEA0183: 2 ports In/Out, V1.5/2.0/3.0/4.0/4.1, 4800/9600/19200/38400 bps NMEA2000: 1 port In/Out External KP: 1 port In/Out
Data sentences	Input : CUR, DBS, DBT, DPT, GGA, GLL, GNS, HDG, HDM, HDT, MDA, MTW, RMC, VHW, VTG, ZDA Output : TLL

## POWER SUPPLY

Display/Control/Transceiver unit	12-24 VDC: 4.7-2.3 A
Hull unit	12/24 VDC: 2.2/1.1 A (7.2/3.6 A: during raising)
Rectifier	100/110/115/220/230 VAC, (RU-1746B-2, option)
	1 phase, 50/60 Hz, 13 A max

## ENVIRONMENTAL CONDITION

Ambient temperature	Display/Transceiver/Control unit -15°C to +55°C Hull unit 0°C to +55°C Transducer 0°C to +35°C
Degree of protection	Display/Control unit IP55 Transceiver/Hull unit IP22 (Raise/Lower control unit: IP55)

## EQUIPMENT LIST

### Standard

Display Unit	MU-121C
Control Unit	CH-502
Transceiver Unit	CH-503
Hull Unit*	CH-504 (400 mm transducer travel) CH-505 (250 mm transducer travel)

### Installation Materials and Spare Parts

\*Depending on the selected configuration

### Option

Remote Controller	CH-256
Rectifier Unit	RU-1746B-2
Control Unit	CH-502
Loudspeaker	CA-151S-ASSY
Display Unit, Installation kit, Cable, Mounting Bracket, Retraction tank	

## Display and Control Unit

MU-121C and CH-502  
4.0 kg 8.8 lb

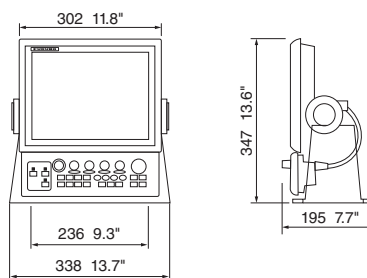

## Transceiver Unit

CH-503  
3.3 kg 7.3 lb

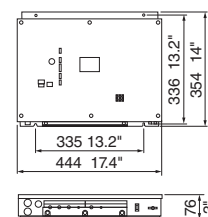

## Control Unit (Tabletop Mount)

CH-502  
1.3 kg 2.9 lb

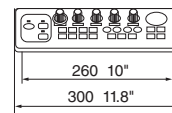

## Hull Unit

(400 mm Travel) :  
CH-504 (6" type)  
34 kg 75 lb

CH-504 (8" type)  
41 kg 90 lb

(250 mm Travel) :  
CH-505 (6" type)  
33 kg 73 lb

CH-505 (8" type)  
40 kg 88 lb

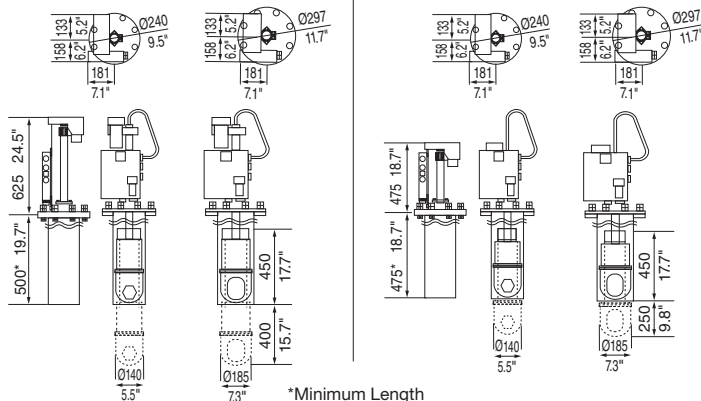

\*Minimum Length

Beware of similar products

All brand and product names are registered trademarks, trademarks or service marks of their respective holders.

SPECIFICATIONS SUBJECT TO CHANGE WITHOUT NOTICE

FURUNO ELECTRIC CO., LTD.  
Japan | www.furuno.com

FURUNO U.S.A., INC.  
U.S.A. | www.furunousa.com

FURUNO PANAMA S.A.  
Republic of Panama | www.furuno.com.pa

FURUNO (UK) LIMITED  
U.K. | www.furuno.co.uk

FURUNO NORGE A/S  
Norway | www.furuno.no

FURUNO DANMARK A/S  
Denmark | www.furuno.dk

FURUNO SVERIGE AB  
Sweden | www.furuno.se

FURUNO FINLAND OY  
Finland | www.furuno.fi

FURUNO POLSKA Sp. z o.o.  
Poland | www.furuno.pl

FURUNO DEUTSCHLAND GmbH  
Germany | www.furuno.de

FURUNO FRANCE S.A.S.  
France | www.furuno.fr

FURUNO ESPAÑA S.A.  
Spain | www.furuno.es

FURUNO ITALIA S.R.L.  
Italy | www.furuno.it

FURUNO HELLAS S.A.  
Greece | www.furuno.gr

FURUNO (CYPRUS) LTD  
Cyprus | www.furuno.com.cy

FURUNO SHANGHAI CO., LTD.  
China | www.furuno.com/cn

FURUNO CHINA CO., LTD.  
Hong Kong | www.furuno.com/cn

FURUNO SINGAPORE  
Singapore | www.furuno.sg

PT FURUNO ELECTRIC INDONESIA  
Indonesia | www.furuno.id

FURUNO ELECTRIC (MALAYSIA)  
SND. BHD.  
Malaysia | www.furuno.my

F-2302LB

Catalogue No. CA000002015