

FURUNO

NAVnet DE



POWERED BY **MAXSEA**

WWW.NAVNET.COM



Adding a New Dimension to 3D

Onboard vessel navigation has undergone something of a revolution in recent years.

Never before has so much information been available to you to improve and enhance your boating experience.

FURUNO's dedication to deliver the most intuitive, integrated onboard navigation solutions has led to the launch of NavNet 3D, a powerful new tool designed to integrate all navigation functions on a modern leisure vessel in one easy to use control unit.

Let NavNet 3D take you easily to routes less travelled.

POWERED BY **MAXSEA**





FURUNO's NavNet 3D allows complex tasks to be performed through a simple user interface.

Cleverly integrating all the instrumentation on your vessel to give you a stress-free boating experience. Once you start using NavNet 3D you will be amazed to see how completely different it is from existing onboard navigation systems.

NavNet3D expands your horizons.



TimeZero™ Technology makes chart redraw a thing of the past.

NavNet 3D utilizes cutting-edge technology, called "TimeZero™". "TimeZero™" facilitates instant chart redraw, allowing you to zoom in and out, change display mode and manage points and routing seamlessly. There is no time lag for redraw, everything takes place in real time. For the ultimate in flexibility and the fastest NavNet 3D redraw, look to the Black Box (MFDBB), which features a super-charged graphics processor.



Instinctive, clear chart presentation.

NavNet 3D adds a whole new dimension to chart presentation. You can choose a 2D aerial view of the navigation chart or a 3D navigation chart with adjustable viewing points. Switch on Satellite PhotoFusion™, and photographic images are incorporated into chart presentation. Driven by a simple user interface, all this information helps to improve your situational awareness by giving you unprecedented control over your charting environment.

NavNet 3D RotoKey™ puts a whole new spin on "User Friendly".

NavNet 3D challenges a conventional menu operation scheme with the new concept the "RotoKey™", on-screen revolving menu keys. By turning a rotary knob on the control panel, RotoKey™ will be activated to give you full access to NavNet 3D controls.



NavNet 3D Features

NavNet 3D is built around a powerful graphic engine, managed by TimeZero™ technology. This system adds new presentation options on top of conventional 2D chart presentation: 3D chart and Satellite PhotoFusion™, a new hybrid blend of detailed satellite imagery containing critical chart data. In these modes it becomes possible to visually grasp the exact position of your craft in a wider perspective.

Navigate in True 3D

NavNet 3D incorporates “native 3D chart architecture” that allows for a full time 3-dimensional presentation, as opposed to 2D charts that require special effects to appear 3-dimensional. With NavNet 3D’s true 3D environment, you can see all of the information you want with no limitations on what information you wish to view. Plan your routes and enter points directly on your raster or vector native 3D charts. Overlay a variety of data with a touch of the RotoKey™, such as Radar overlay, AIS and ARPA targets plus all of your chart symbols and depth soundings; any and all of the information can be displayed at will. This is the beauty of navigating in NavNet 3D, you have full control over the presentation at all times.

Satellite PhotoFusion™

Our high-resolution satellite photography can now be fused with raster or vector chart information. Land areas (zero depth) are completely opaque, so that these areas are displayed with high-resolution satellite photos on the chart. As the depth increases, the satellite photography becomes more transparent so that you will know where the shallows end and the deeper water begins. High-resolution satellite photography aids in seabed classification so that you will be able to easily identify areas of sand, rock, coral, and other obstructions.

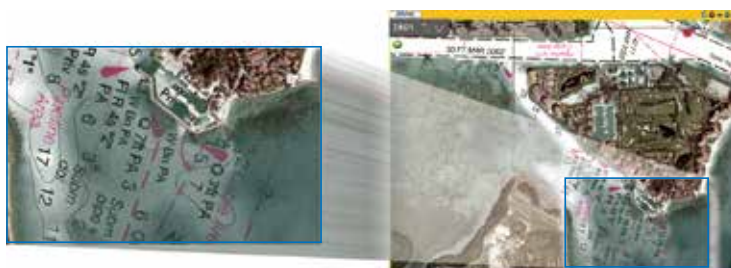

Satellite & Raster/PhotoFusion™
(High-resolution)



3D Raster



3D Vector

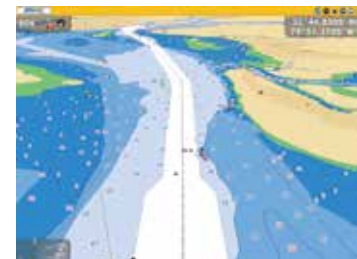

C-Map by Jeppesen 3D Vector (option)*

* For detailed information, please refer to page 17-18.



Satellite & Vector/PhotoFusion™
(Low-resolution)

The high-resolution photography for Satellite PhotoFusion™ is not available in certain areas. Please consult with the distributor in your area for availability.



3D Key

Even though the charts are always operating in their native 3D environment, one long press of the 3D key will toggle the chart from 3D to a familiar 2D, top-down perspective and vice versa.



3D



2D



Satellite & 3D chart orientation (with bathymetric data)

Bathymetric data is needed to display Satellite PhotoFusion™ in 3D. Without the bathymetric data, you can still view the perspective 3D. (without contour elevation)



Satellite & 3D perspective view (Without bathymetric data)

Bathymetric data is currently under development in some areas. Please consult with the distributor in your area for availability.

The Only Acceptable Wait Time is Zero: TimeZero™ Technology Changes Your Perspective on Chart Redraw

Its high-speed processor and powerful graphic engine deliver TimeZero™ technology that facilitates seamless chart handling, zooming and panning without the screen disappearing. Blink and you will miss it! TimeZero™ will dramatically speed up your onboard decision-making

Chart scaling without limitation

This completely new system design allows you to zoom seamlessly and continuously to whatever chart scale you desire. Instead of limiting you to a small handful of chart scales to choose from like traditional chart plotters, TimeZero™ architecture allows you to zoom in or out to the exact magnification level you like without steps or limitations.

NAVnet
3D

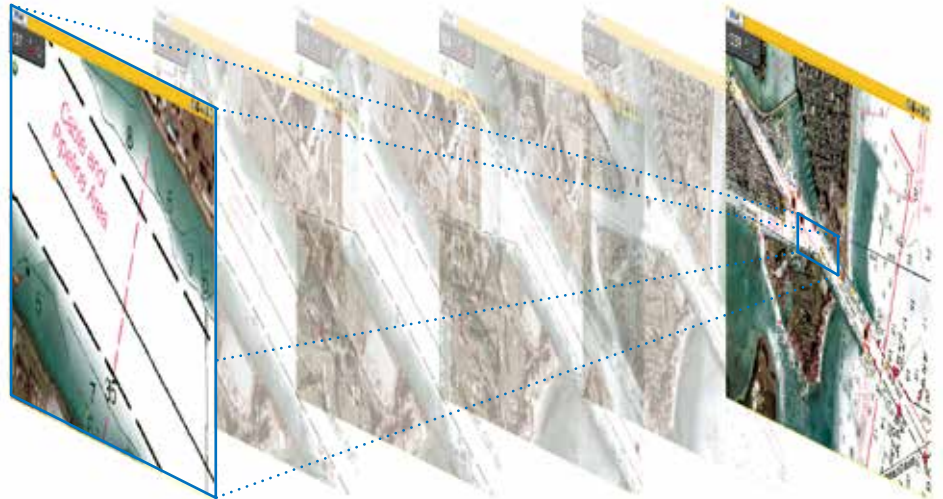

Smooth scaling delivers any range scale you desire.

Conventional Chart Plotter

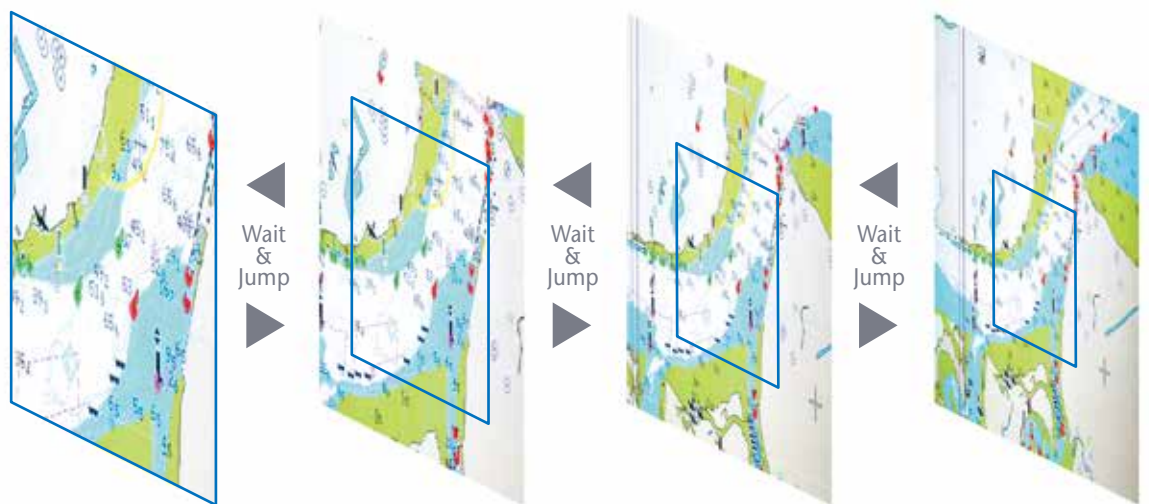

Conventional chart plotters have fixed range scales that you select from.

by greatly simplifying chart handling actions. NavNet 3D TimeZero™ technology redefines the meaning of stress-free operation. For the ultimate performance in chart redraw, step up to the NavNet 3D Black Box.



Easy chart panning gives you freedom to explore

You can pan the chart freely by simply pressing the scrolling pad. This gives you freedom to explore the chart, allowing you to focus on a specific area ahead of or around your craft with greater intensity without losing track of your position on the chart. Explore the chart data at your leisure, and then instantly return to own ship at the touch of a single dedicated button. Displaying True and Relative Motion is now more intuitive than ever before. TimeZero™ technology provides a useful utility for focusing on a specific direction such as the area ahead of your craft.

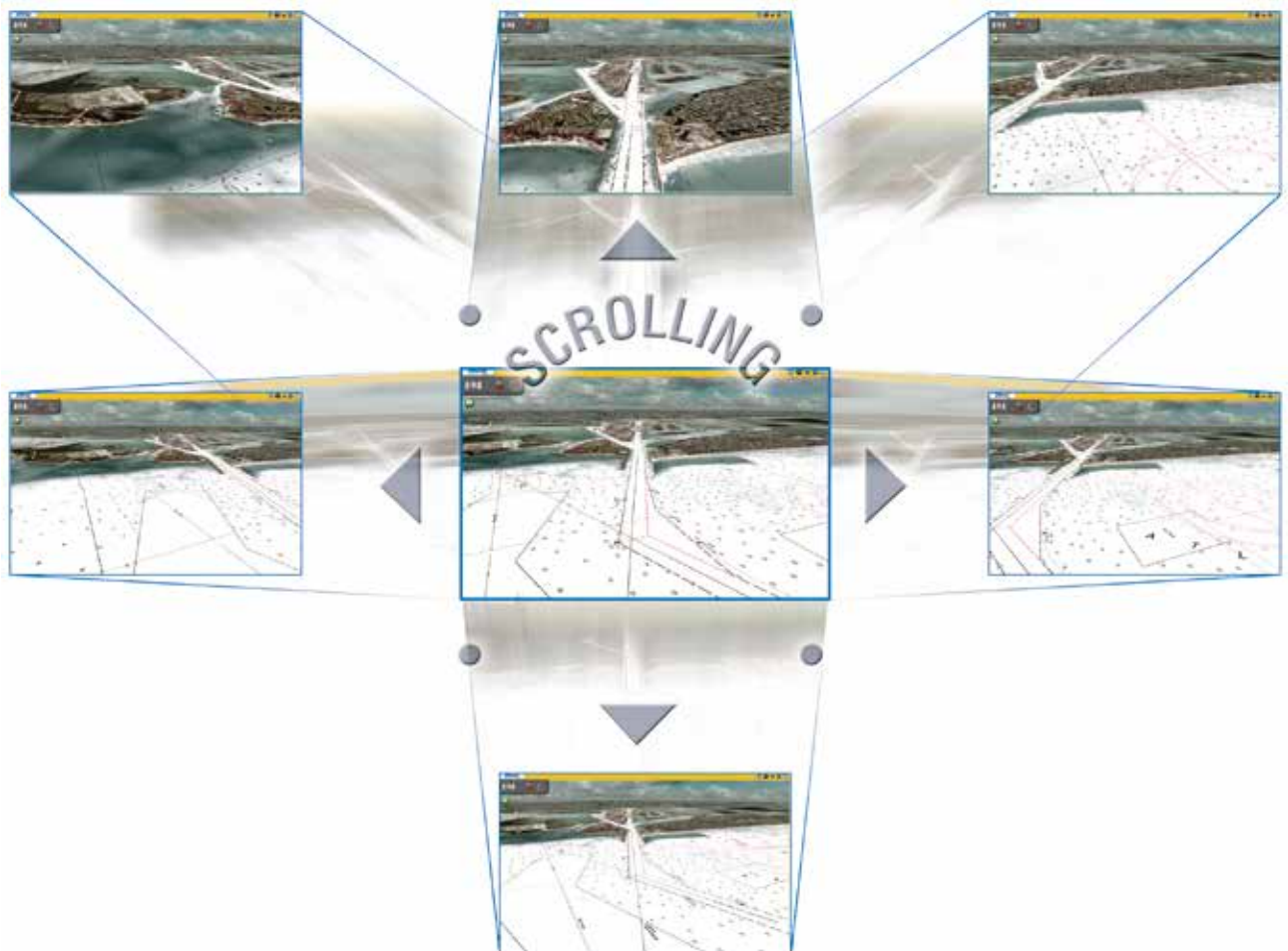

Scalable operating system accommodates everyone from new boaters through to experienced navigators

NavNet 3D is designed to give you a user-friendly operating environment all the time through its scalable operating system. NavNet 3D's scalable operating system allows you to select the functions you wish to control from an extensive list of options.

1 Point & Shoot Interface

NavNet 3D allows for a more straightforward user interface with a combination of both RotoKey™ and a familiar point-and-shoot cursor pad control. The power of point-and-shoot interface allows for incredibly simple operation - click anywhere on the screen for context-sensitive options for that area. Click on any data box to access detailed information for that function. A variety of features can be accessed through a familiar left or right click interface. You can also connect a generic USB mouse to further simplify operation.

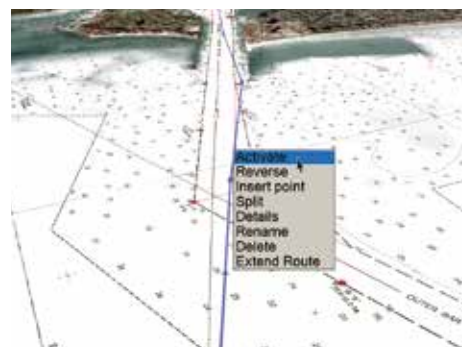

2 DISP Key

One press of the DISP button allows you to easily select the presentation you desire. Five intelligently designed hot-pages are available to you right out of the box, with the ability to save up to ten custom hot-pages. Customize any hot-page with a simple long press of the RotoKey™, which launches the hot-page wizard.

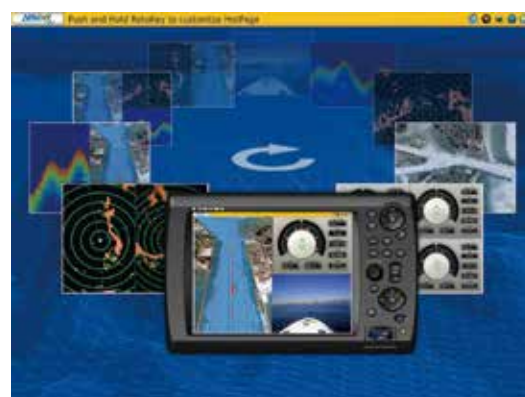

Hot-page wizard



3 RotoKey™

This is NavNet 3D's revolutionary new control that merges the power and versatility of soft keys with an easy-to-use rotary knob! One turn of the RotoKey™ gives you instant access to full control of NavNet 3D. The RotoKey™ is designed as a part of NavNet 3D's scalable operating system; a short press of the RotoKey™ gives you access to a user-selected set of the functions that you select upon installation from Basic, Standard, Full or Custom, while a longer press of the key displays all of the functions available. Never leave your navigation screen to enter a menu again!



4 Range Key

Simple press of the Range key allows you to adjust to the range scale of your choice with smooth zooming-in/out actions—thanks to TimeZero™ technology.

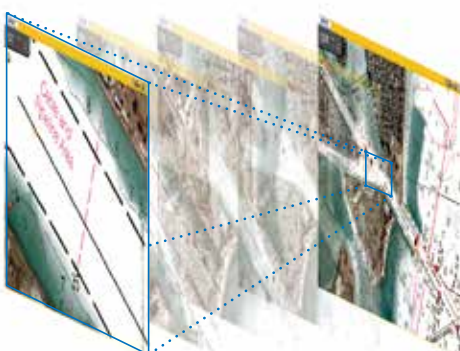

5 Scrolling Pad

The scrolling pad allows independent scrolling and panning capabilities from a dedicated omni-pad. Pan the chart or shift the radar quickly and seamlessly. You can also control Axis IP cameras without accessing complicated menus or changing your current presentation.

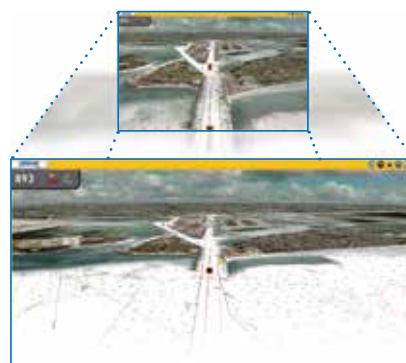

6 3D Key

One long press of the 3D key will toggle the chart from 3D to a familiar 2D, top-down perspective. While the chart remains in its native 3D environment, only the perspective shifts. Press the key again and you toggle back to 3D. There is no special mode required to shift back to 3D perspective.



FURUNO NavNet 3D Digital Solution sets a new Standard

NavNet 3D operates in a fully digitized environment with its highly sensitive digital sensors for radar and fish finder. NavNet 3D is not just that! Its operating structure is also digitized, delivering a total fusion of hardware and software modules in its operation scheme, utilizing Ethernet, NMEA0183 and CAN bus interface.



New Ultra High Definition (UHD™) Digital Radar

NavNet 3D integrates Ultra High Definition (UHD™) Digital Radar. This facilitates fully automatic, high precision Gain and Sea Clutter and Tuning Control for hands-free operation and optimum performance. One of the most striking features of FURUNO UHD™ Digital Radar is a fully independent “Real-Time” dual range radar display, which scans and displays two different radar ranges simultaneously with no lag at all. UHD™ Digital Radar is fully integrated into NavNet 3D’s revolutionary TimeZero™ technology, facilitating real seamless radar zoom without any display blackout (MFDBB). Also, the high-resolution radar image can perfectly be overlaid with NavNet 3D’s native 3D chart in both 2D and 3D formats. All of these greatly enhance your situational awareness.

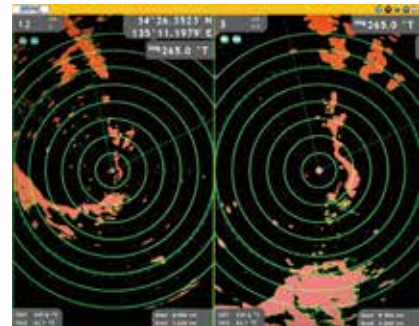

FURUNO Digital Filter (FDF™) Fish Finder

You probably know about digital fish finders, but are not quite sure what they really mean. FURUNO Digital Filter (FDF™) fish finders feature advanced filtering capabilities and digital auto tuning, which eliminate noise and hence automatically spotting individual fish with staggering accuracy and detail. Whether it is used for shallow or deep water, FURUNO FDF™ fish finder gives you what you would expect from a fish finder at all times.



Enhanced shallow water detection by suppressing surface clutter.



DFF1

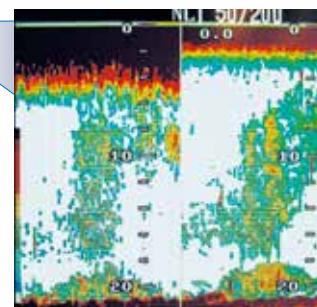

Conventional fish finder

NavNet 3D Digital Sensors

Reliability of NavNet 3D lies in its excellent sensor performance, which is the result of the application of advanced Digital Signal Processing to both NavNet 3D radar and fish finders. These NavNet 3D digital sensors greatly boost your target detection and presentation capabilities.

Ultra High Definition (UHD™) Digital Radar

FURUNO has taken its NMEA award-winning radar technology to the next level with Ultra High Definition Digital Radar. UHD™ offers crystal clear target presentation with automatic real-time digital signal processing. Antenna rotation speed (24/36/48 rpm) is automatically shifted appropriate to the pulse length you operate with. Commercial-grade radar performance is now available in the NavNet 3D ultimate leisure navigation suite.



NavNet 3D Real-time Digital Auto Gain/Sea Clutter Controls

NavNet 3D employs revolutionary real-time digital auto Gain/Sea controls to deliver crystal clear radar presentation. With this new technical application, NavNet 3D computes and applies an adaptive omni-directional anti-clutter filter with variable intensity depending on bearing.



Auto Gain/Sea Controls On



Auto Gain/Sea Controls Off



Auto Gain/Sea Controls On

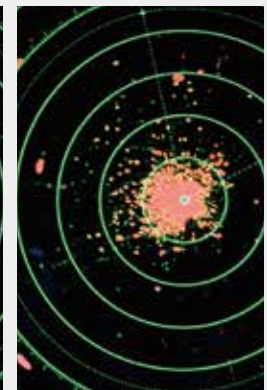

Auto Gain/Sea Controls Off

Real-time Dual Range Radar

NavNet 3D's simultaneous scanning technology drives our powerful dual-range radar, providing unsurpassed target detection. With each sweep of antenna, dual progressive scan transmissions are sent, received and processed to display two separate radar ranges on your NavNet 3D display all at the same time. Each radar presentation acts autonomously, allowing for manipulation of individual gain and clutter controls.

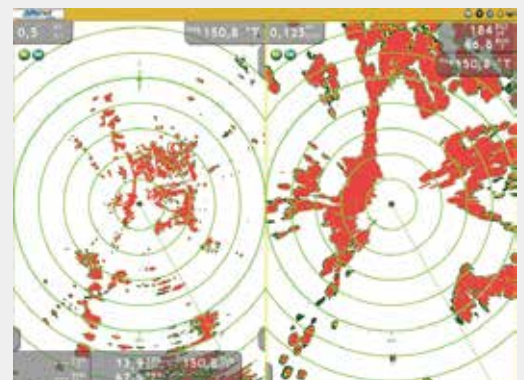



FURUNO Digital Filter (FDF™) Fish Finder

FURUNO's DFF1 and DFF3 and new BBDS1 feature the FURUNO Digital Filter (FDF™) technology. These new digital Network Sounders can turn any NavNet display into a powerful, dual frequency digital fish finder.



The main difference between digital and conventional fish finders lies in the filtering capabilities and auto adjustments. Our award winning FDF™ technology helps to optimally adjust gain, STC (Clutter) and output power as well as suppress surface clutter. It also makes the picture clearer and easier to decipher. However, even the best digital filter won't help unless you start with a solid basis, such as FURUNO's renowned fish finder technology. This is why FURUNO has been the best friend of fishermen for generations.

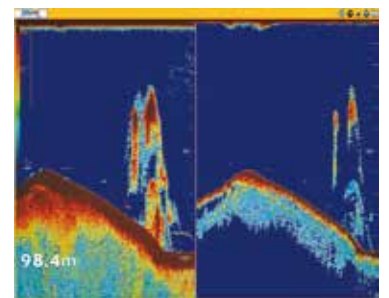

Bottom Discrimination Display (with BBDS1 only)*

NavNet 3D can show the bottom discrimination information from the depth sounder echogram. Utilizing the new Network Fish Finder BBDS1. Bottom discrimination can be displayed in four categories. "Rock", "Gravel", "Sand" and "Mud", in either easy to read graphics of color display modes. The bottom discrimination function provides you with valuable information to help you locate rich fishing grounds to boost the days catch. There are two bottom discrimination display modes selectable:

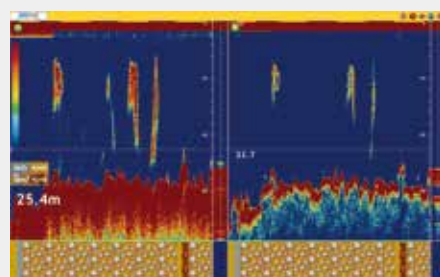

Standard mode:
Only the most prominent bottom category of the spot will be displayed.

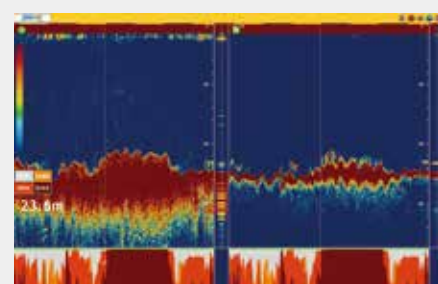

Probability mode:
The proportion of the bottom sediment of the spot is displayed in graph.

* Bottom discrimination display mode can be used in the following conditions:

Water depth: 5 m and deeper**

** Please note, the water depth figures above are a guide only and operational performance may vary depending on transducer installation technique and the acoustic environment around the vessel.

NavNet 3D Network: Building Block Solution

NavNet 3D is built on an Ethernet network, allowing you to add as few or as many components as you desire along with up to ten displays to create your perfect navigational suite. Further, you can connect NMEA0183 and CAN bus devices to any display or BB processor and share that information across the Ethernet network automatically. User setting data can also be transferred by using SD cards for synchronization of operation settings amongst networked displays. Power on/off synchronization amongst all of the NavNet 3D display units can be



RADAR



ARPA Radar
FAR-2xx7 Series
 FURUNO ARPA/RADAR Series FAR-2xx7 can be connected to NavNet 3D through the Ethernet data link.



Radar Sensors

FISH FINDER



Network Fish Finder
DFF1/DFF3
BBDS1



Color LCD Sounder
FCV-1150

All the NavNet 3D radar sensors incorporate a CAN bus port to which certain CAN bus/NMEA2000 sensors can be directly connected. Power for these networked sensors is supplied directly from the radar itself. This unique feature allows for flexible installation of multiple CAN bus/NMEA2000 sensors without the need to run cables all the way to the main processor unit. CAN bus/NMEA2000 data is converted and distributed throughout the NavNet 3D Ethernet network.

GPS



GPS/WAAS Antenna
GP-330B

GPS



GPS Navigator
GP-33

GPS



GPS/WAAS Antenna
GP-320B

Contact

External alarm output & point/
 MOB alert input

Stereo

Variable line level/
 stereo output













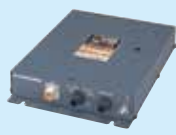



MOB Pendant System Ready

Any NN3D system is compatible with every Wireless MOB Pendant System through the MOB Contact Closure Input.

achieved when the dedicated Ethernet hub HUB101 is used.

The NavNet 3D system is built upon the most advanced chart plotter technology. Add to this UHD™ Radar and FDF™ Fish Finder, along with your choice from a wide variety of sensor options and up to ten displays. In addition, FURUNO's NAVpilot autopilot can also be connected to the system. It is easy to see how the basic chart plotter display becomes the genesis of the most sophisticated navigational suite available.

<p>AIS</p>  <p>AIS Receiver FA-30</p>  <p>Class-B AIS Transponder FA-50</p>	<p>FAX</p>  <p>Network Weather Facsimile Receiver FAX-30</p>	<p>PC</p>  <p>MAXSEA TimeZero Explorer PC Software</p>	<p>CAMERA</p>  <p>IP Camera</p>	
<p>INSTRUMENT</p>  <p>FI-70</p>	<p>AUTOPILOT</p>  <p>NAVpilot-711C</p>  <p>NAVpilot-700</p>	<p>COMPASS</p>  <p>Integrated Heading Sensor PG-700</p>	<p>DISPLAY</p>  <p>Remote Display RD-33</p>	<p>SENSORS</p>  <p>Depth/Speed/Temp Sensor DST-800</p>
		 <p>Satellite Compass SC-30</p>  <p>Satellite Compass SC-50/110</p>  <p>Integrated Heading Sensor PG-500</p>		

***What is CAN bus?**

CAN bus is a communication protocol that shares multiple data and signals through a single backbone cable. You can simply connect any CAN bus devices onto the backbone cable to expand your network onboard. With CAN bus, IDs are assigned to all the devices, and status of each sensor in the network can be detected. All the CAN bus devices can be incorporated into the NMEA2000 network.

CHART PLOTTER

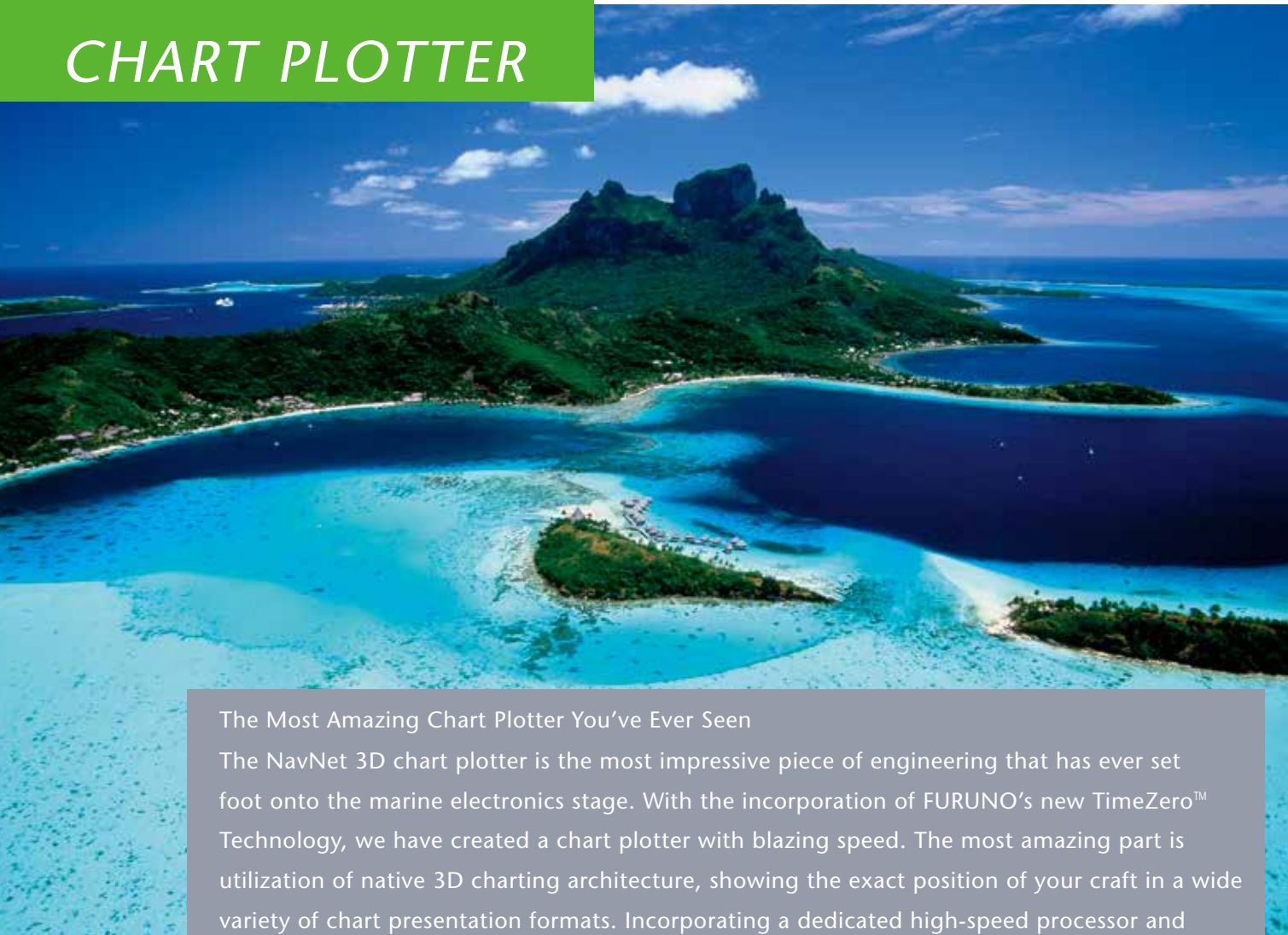

The Most Amazing Chart Plotter You've Ever Seen

The NavNet 3D chart plotter is the most impressive piece of engineering that has ever set foot onto the marine electronics stage. With the incorporation of FURUNO's new TimeZero™ Technology, we have created a chart plotter with blazing speed. The most amazing part is utilization of native 3D charting architecture, showing the exact position of your craft in a wide variety of chart presentation formats. Incorporating a dedicated high-speed processor and powerful graphic engine, NavNet 3D delivers unprecedented levels of performance and utility by seamlessly integrating diverse, essential navigational data.

NavNet 3D expands its versatility with the addition of "C-Map by Jeppesen" charts*

NavNet 3D is the only chart plotter on the market providing users the ability to choose from pre-loaded official NOAA raster and vector charts, or optional "C-Map by Jeppesen"* and "Datacore by Navionics" vector cartography. Fully integrating the cutting-edge data analytic algorithm together with high-resolution image processing technique, Mapmedia delivers digital navigation charts and satellite photography with absolute clarity and detail. Mapmedia vector and raster charts are built upon 3D architecture, which is smoothly integrated with NavNet 3D's TimeZero™ technology.



Mapmedia Raster

Raster charts are digitized scans of NOAA paper charts. For the traditionalist who is used to the touch and feel of a paper chart, Mapmedia raster is the option for you. Unlike conventional raster charts, high-resolution scans have been applied to Mapmedia raster so that the chart quality will not deteriorate even when viewed at the smallest of range scales.



Mapmedia Raster



Radar-Chart overlay

Mapmedia Vector

Vector charts contain a huge volume of information in different layers, each of which can be selectively displayed. As you zoom into the chart, increasing levels of detail can be seen without any sacrifice in image resolution.



Mapmedia NOAA Vector



NOAA Vector + Satellite PhotoFusion™

NavNet 3D now offers three different sources of vector chart options with the addition of C-Map by Jeppesen*. Optional "C-Map by Jeppesen" vector cartography* delivers a wealth of important chart detail for navigation, including spot soundings and depth contours.



*A software update (v2.05) will be necessary to use the new "C-Map by Jeppesen" charts, which will be available for download at www.NavNet.com.



Mapmedia C-Map by Jeppesen 2D Vector

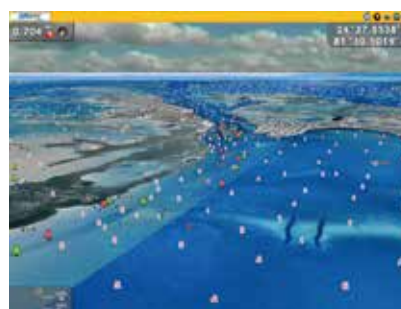

C-Map by Jeppesen 3D Vector + Satellite PhotoFusion™

Satellite PhotoFusion™

Satellite photography is included in the Mapmedia Raster and Vector charts, and Satellite PhotoFusion™ with the charts is a feature available only with FURUNO's NavNet 3D. Land areas (zero depth) are completely opaque, so that these areas are displayed as satellite photos on the chart. As the depth increases, the satellite image is merged with the chart data to provide you, the user, with added detail on seabed areas in shallow water without losing vital chart information. In deeper water where the satellite image has no detail to offer, the chart is displayed without alteration. This ensures that navigational integrity is not only maintained but also enhanced where it is most needed in areas where grounding might be a risk.

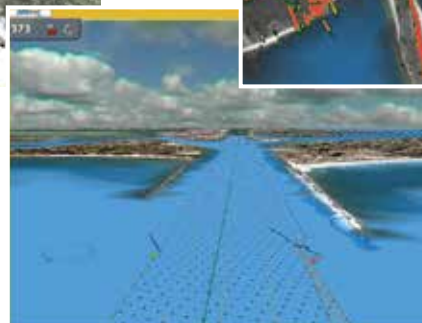

On top of the cartography, you can save the following marks and points in the NavNet 3D internal memory:

- ▶ Up to 10,000 ship's track points;
- ▶ Up to 2,000 points and
- ▶ 200 planned routes, within which up to 100 waypoints can be placed.

Depth Shading

A depth color scale can be applied on both 2D and 3D vector and raster charts. Transparency levels can be adjusted so that the chart data is visible beneath the color shading. This unique feature allows you to view water depths at-a-glance with vibrant colors. No more searching for depth numbers, when you can simply set depths to your specified colors. Whether you want to see the depth for navigation or fishing purposes, this new feature makes it easier than ever.

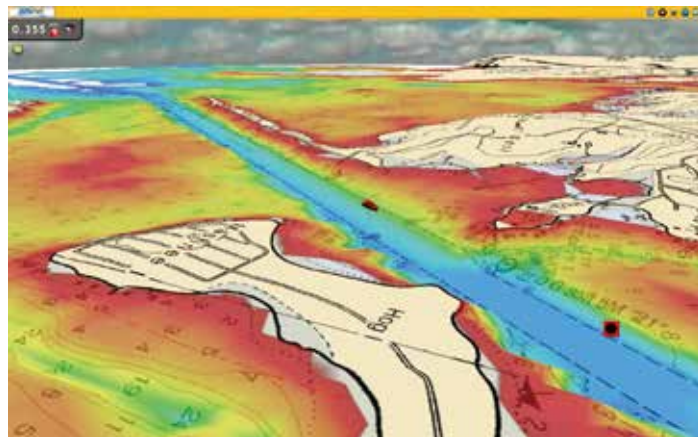
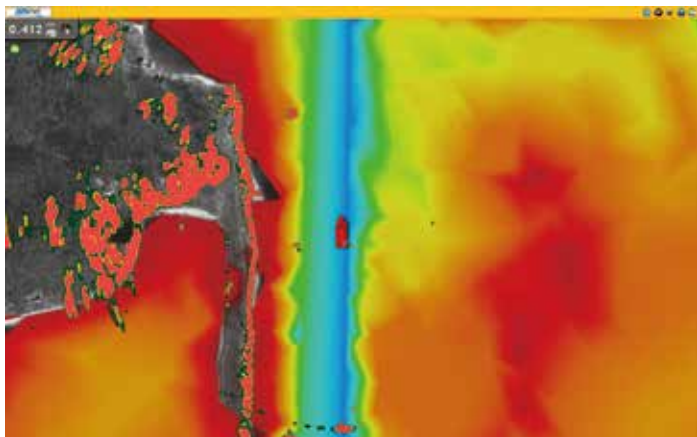

Bathymetric data is needed to display underwater presentation in 3D. Bathymetric data is currently under development in some areas. Please consult with the distributor in your area for availability.

Preloaded Tides information

NavNet 3D also comes preloaded with tides information of worldwide coverage, which can be overlaid with the chart display.

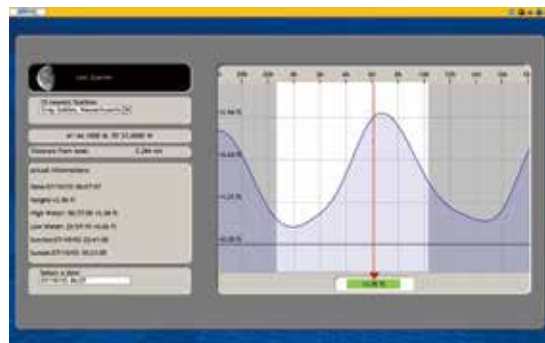

Tide Symbol

Tide symbols are located where tide stations are. When you place the cursor over a tide symbol, the symbol is magnified.



By selecting a tide symbol, you can view a graph for predictions for maximum and minimum tide heights as well as times for sunrise and sunset.

NAV Data Display and Engine Monitoring

NAV Data Display

Selected NAV data can be shown at the edges of the screen in nav data windows.



1 Range Data

Automatically changes range scale settings between long range (mile, nautical mile or kilometer) and short range (foot, meter or yard) according to the current display range.

2 Cursor Data

Shows the latitude and longitude position where the cursor is on the chart.

Information to be displayed

- ▶ Position
- ▶ Range
- ▶ Bearing

3 Ship's Data

These user-specified data boxes allow you to display the information you want to see. Customize the data boxes to show single or multiple pieces of information. Click on the box and it will show you the variety of data you can display. When you select multiple data, it will rotate at a specified time interval.

Information to be displayed

- ▶ Position
- ▶ COG
- ▶ SOG
- ▶ Depth
- ▶ SST
- ▶ STW
- ▶ Heading
- ▶ True Wind Speed
- ▶ True Wind Direction
- ▶ True Wind Angle
- ▶ Apparent Wind Speed
- ▶ Apparent Wind Angle
- ▶ ROT
- ▶ Trip Log
- ▶ Odometer
- ▶ Date and Time

On-screen Navigational Instrument

NavNet 3D delivers various on-screen navigation instrument displays.



1 Compass Rose display

In the Compass Rose display, you can view the heading, bearing to the waypoint and COG information at the same time in order to see if your craft is on the right track.

2 Engine Monitoring

When interfaced with an engine that outputs data in NMEA 2000® format, NavNet 3D can show an on-screen engine monitoring display. The information displayed includes: tachometer, boost pressure, engine temperature and oil pressure.

3 Wind Speed and Direction

Either true or apparent wind speed and direction can be shown, when interfaced with a wind sensor.

RADAR

NavNet 3D Radar

NavNet 3D's new Ultra High Definition (UHD™) Digital Radar technology sets a new standard in marine radar. With highly advanced digital sensor and signal processing technologies, UHD™ Digital Radar greatly enhances situational awareness.



Real-time Dual Range Radar presentation thanks to dual progressive scan method

NavNet 3D simultaneous scanning technology allows dual progressive scan to display and update two radar pictures of long and short range at the same time, as opposed to alternate update of two different radar range scales in typical conventional dual range radar. Autonomous control over gain and anti-clutter can be performed on each radar display in the dual radar mode. This can be used to have one screen with the gain set to locate birds and buoys, while you use the other radar screen to navigate.

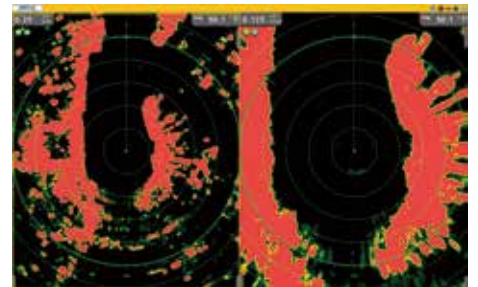

Radar-Chart overlay

Radar image of spot-on accuracy can be overlaid with the chart information. Not only is it done with the conventional 2D chart format, but also it can now be projected onto 3D chart presentation! Radar range scales in the radar-chart overlay entirely depend on the range scales in the chart presentation, allowing you to view the radar image on the chart information in whatever magnification level you desire. (Appropriate heading sensor is required.)

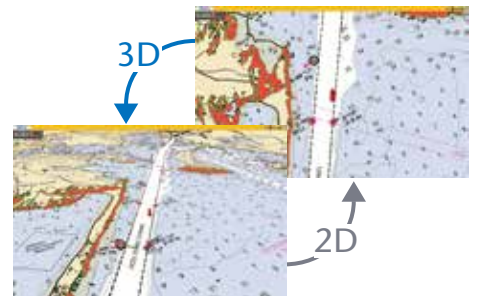

ARPA/AIS target tracking

Automatic radar plotting utility is one of the standard features of the NavNet 3D radar. Up to 30 targets can be simultaneously acquired and tracked to show you the heading direction and speed of the targets. AIS target tracking can also be performed when the FA-30/50/150 is interfaced with NavNet 3D.

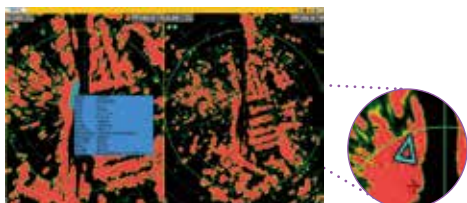

Real-Time Digital Auto Gain/Sea Controls

NavNet 3D employs revolutionary real-time digital auto Gain/Sea controls to deliver crystal clear radar presentation. With this new technology, NavNet 3D computes and applies an adaptive omni-directional anti-clutter filter with variable intensity depending on bearing.

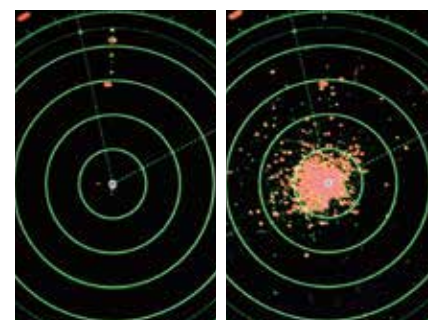

Auto Gain/Sea Controls On

Auto Gain/Sea Controls Off

Auto Gain/Sea Controls On Auto Gain/Sea Controls Off



- ▶ Enhanced detection both in long and short range by Digital Radar Sensor
- ▶ Seamless zoom in/out radar range scales (MFD8B)
- ▶ Enhanced auto gain and anti-clutter controls and auto tuning
- ▶ 48 rpm antenna rotation speed for HSC and river applications
- ▶ Adaptive antenna rotation speed according to pulse length
- ▶ Spot-on radar overlay on both 2D/3D chart presentation with aid from heading sensors
- ▶ True echo trail shows an afterglow of moving radar targets
- ▶ True Color Radar shows density of targets
(32 color levels for the MFD8 and MFD12, 256 color levels for the MFD8B)
- ▶ Radar Guard Zone and Watchman features alert you to potential danger
- ▶ Dual VRM (Variable Range Markers) and dual EBL (Electric Bearing Lines) give distance and bearing indications
- ▶ Off-center display allows you to focus on specific direction with a simple press of the cursor pad
- ▶ IP address is automatically assigned to deliver Plug and Play installation



Radar Sensors

The NavNet 3D radar processor is incorporated into a Radome antenna or a gearbox for an open antenna. Simply plug in Ethernet and power cable connectors, and you will have a digital radar sensor within your NavNet 3D network. The IP address is automatically assigned to the radar sensor upon plugged into the network, facilitating real Plug and Play installation.

NavNet 3D Radar Sensor Options

	DRS2D	DRS4D	DRS4A	DRS6A	DRS12A	DRS25A
Output Power	2.2 kW	4 kW	4 kW	6 kW	12 kW	25 kW
Size	19 inch	24 inch	3.5 ft	4 ft	4 ft/6 ft	4 ft/6 ft
Antenna Type	Radome	Radome	Open	Open	Open	Open
Beam Width	Horizontal	5.2°	4.0°	2.3°	1.9°	1.9°/1.4°
	Vertical	25°	25°	22°	22°	22°/22°
Max. Range	24 nm	36 nm	48 nm	64 nm	72 nm	96 nm
48 rpm Capability	●	●	●	●	●	●

FURUNO CAN bus network

The NavNet 3D radar sensor incorporates a CAN bus port to which FURUNO's CAN bus sensors such as the Weather Station, THE GP-330B GPS Sensor and the SC-30 Satellite Compass can be directly connected. Power for these networked CAN bus sensors is supplied from the CAN bus. This unique feature allows for flexible installation of multiple CAN bus sensors without the need to run cables all the way to the main processor unit. CAN bus data can be converted and distributed throughout the NavNet 3D Ethernet network.

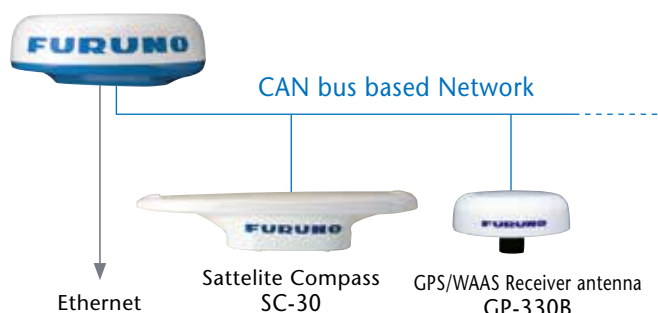

FISH FINDER



NavNet 3D Network Fish Finder

FURUNO DFF1 and DFF3 and new BBDS1 can turn any display into a powerful, dual frequency digital fish finder. Connect directly to a Multi-Function Display, Black Box or to an Ethernet hub with a single Ethernet cable. The DFF1 and new BBDS1 have 600 W or 1 kW output power, while DFF3 has 1/2/3 kW output power. Both support a variety of transducer options.



BBDS1

Bottom Discrimination Display

The BBDS1 is the latest addition to the product line-up of network fish finders, which enables NavNet 3D to display seabed bottom discrimination.

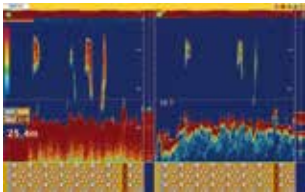

Standard mode

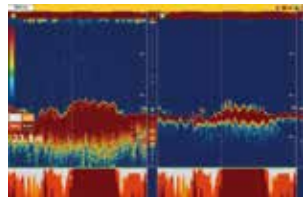

Probability mode

For detailed information, please refer to page 14.

- ▶ Enhanced detection of fish targets by FURUNO Digital Filter (FDF™) Fish Finder technology
- ▶ Selectable display modes include High or Low Frequency, Dual Frequency, Zoom, Nav Data, A-Scope, Marker Zoom, Bottom Zoom or Bottom-Lock
- ▶ New Bottom Discrimination Display mode available (BBDS1)
- ▶ FURUNO Free Synthesizer (FFS) transceiver to let you choose any two operating frequencies from 28 to 200 kHz (DFF3)
- ▶ Audio and visual alarms alert you whenever preset limits are met for water depth, water temperature and fish echoes
- ▶ Two selectable automatic gain control modes: Cruising and Fishing
- ▶ IP address is automatically assigned for true Plug and Play

Network integration with NavNet 3D

Via Ethernet interface, the FCV-1150 brings professional fish finding technologies onto the NavNet 3D network. This advanced configuration enables you to install the FCV-1150 anywhere onboard within reach of a LAN cable. Auto range, auto gain, shift and zoom controls can be performed from both NavNet 3D and the FCV-1150**.

** Manual gain control and mode selection can only be done by the FCV-1150.



12.1" COLOR LCD SOUNDER
FCV-1150



FCV-1150

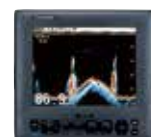

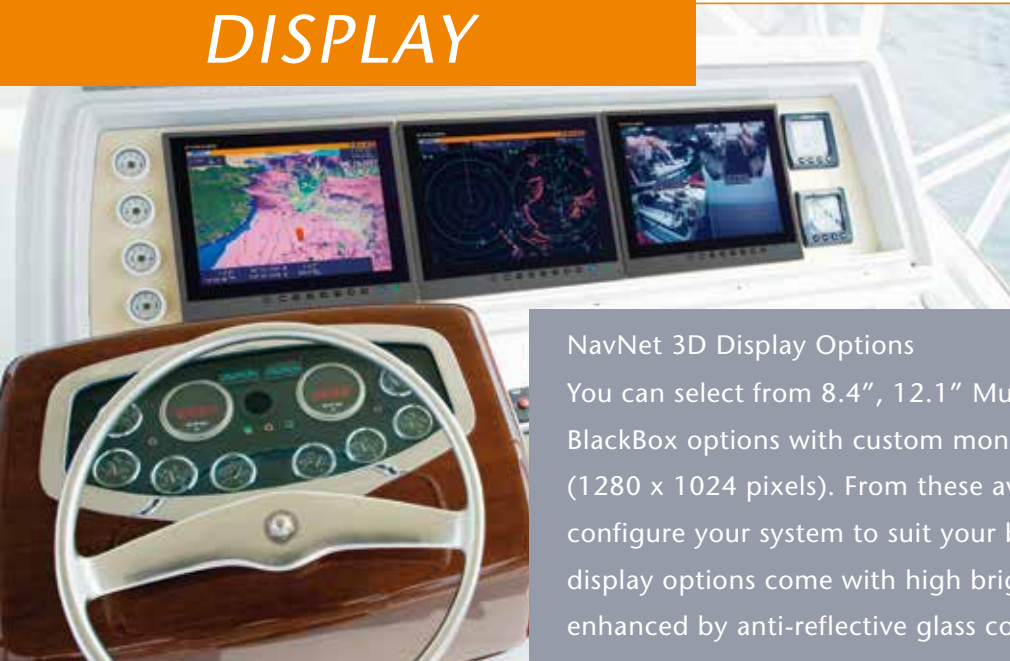

NavNet 3D Display Options

You can select from 8.4", 12.1" Multi Function Displays (MFDs) or BlackBox options with custom monitors of screen resolution up to SXGA (1280 x 1024 pixels). From these available options, you can freely configure your system to suit your boating style. All of these NavNet 3D display options come with high brightness, sunlight viewable capability enhanced by anti-reflective glass coating that allows operation even under the direct sunlight.

8.4" and 12.1" MFDs

Choose from 8.4" or 12.1" NavNet 3D MFDs. Its low profile design fits beautifully right into your helm console. Fog-free structural design has been applied to both MFD8 and MFD12 so that the presentation will never be disturbed by water condensation, caused by air gap between the LCD and the front coverplate.

MFD8



MFD12



BlackBox Configuration

The NavNet 3D BlackBox configuration is available for those who wish to make use of a display of your choice together with a powerful NavNet 3D BB processor. You can select either FURUNO's lineup of 15", 19" Marine LCDs or other third party displays.



DCU12



MFDBB Processor

Combine 12.1" Display Control Unit (display with keyboard control unit) DCU12 together with MFDBB Processor to configure the NavNet 3D BlackBox system

N.B., NavNet 3D Processor is not included in the DCU12.

MU-150HD/MU-190HD
Marine LCDs



MFDBB Processor



MFDBB Keyboard

Combine FURUNO's Marine LCD MU Series with MFDBB Processor and Keyboard to configure the NavNet 3D BlackBox system

Easy Flush Mount Installation

Flush mount installation can be done more easily than ever. All the NavNet 3D display options attach to the mounting console with bolts from the front side.



NavNet 3D Display Options

	MFD8	MFD12	MFDBB
Screen Size and Resolution	8.4" LCD VGA (640 x 480) Video Out Resolution: VGA	12.1" LCD SVGA (800 x 600) Video Out Resolution: SVGA	12.1" SVGA (800 x 600) 15" XGA (1024 x 768) 17" SXGA (1280 x 1024)
Brightness	700 cd	1100 cd	
NMEA0183 in/out	3 x in/out ports		
CAN bus/NMEA2000®	1 port		
Ethernet (100 BASE-TX)	1 port		4 port hub included
USB	1 x USB 1.1		2 x USB 2.0
Video IN (NTSC/PAL)	2 inputs		4 inputs
SD Card Slot	2 slots		2 slots in a control unit
Audio IN/OUT	1 output		

Changing display arrangements is simpler than ever before!

NavNet 3D allows you to customize your display from a single screen presentation up to a four-way-split arrangement. NavNet 3D comes standard with five display hot-pages to select, with the ability to increase your options to ten hot-pages. Rearrange the display configuration to suit your style by combination of the DISP key and RotoKey™. You can freely configure the display so that you will have the information you want right where you want it!

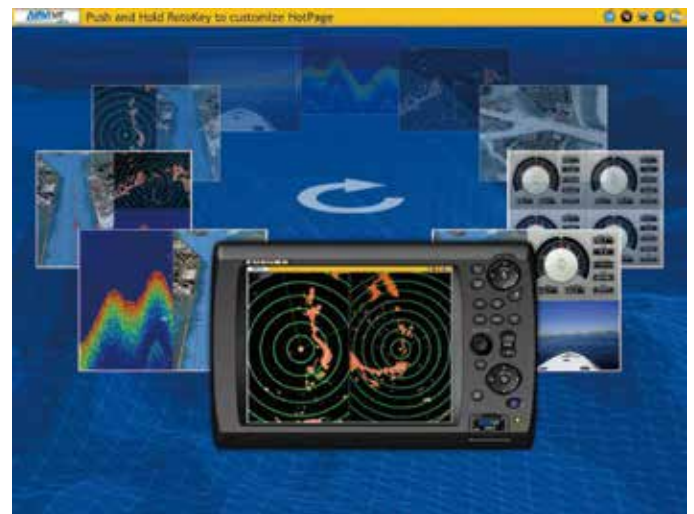

Single Screen Display

In this mode, you can place the presentation of chart plotter, radar, fish finder and external video camera.



Split-Screen Display

NavNet 3D allows you to split the screen up into four separate segments. In each segment, you can place the following information.

- 1 You can place the presentation of chart plotter, radar, fish finder and external video camera in the halfway-split screen.
- 2 In the quarter-split-screen, you can place the presentation of chart plotter, radar, fish finder, external video camera and navigation instruments.



Chart plotter



Radar



External video camera



Fish finder



Navigation instrument

Status Bar and Status Icons

The status bar at the top of the display provides you with operating information with text messages and sensor status icons.

Default



Bar color turn to red

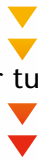

Emergency



Sensor Status Icons

The sensor status icons show whether the sensors are active or inactive. The sensor icons are animated when active, and a red "X" is placed over the icons when inactive.



	Sensor working in order	Sensor inactive
Multimedia		
Compass		
GPS		
Fish Finder		
Radar		
Weather*		

* USA only

Text Message

The text messages include operational guide and alarm messages. When set alarm criteria are met or violated, the status bar turns red and the warning status message is shown in the status bar.



IP Camera & External Video Camera Displays

NavNet 3D displays video input from onboard IP cameras and analog video cameras, allowing you to monitor the engine room and surroundings while navigating from the helm or keeping an eye on blind spots while docking. The MFD8 and MFD12 incorporates two video input ports, while the MFD8B has four video input ports, supporting multiple video sources to be displayed at the same time for enhanced navigation monitoring. Up to four IP cameras can be connected to the network. Pan, tilt and zoom features can be controlled from the NavNet 3D scrolling pad when utilizing Axis IP cameras with these capabilities.

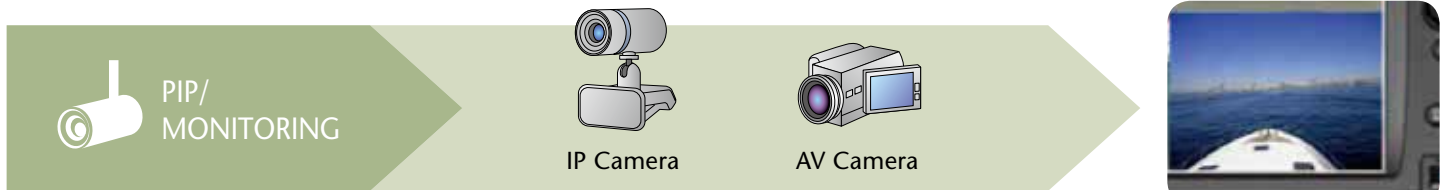

Onboard Monitoring



Engine Room Monitoring



SYSTEM EXPANDABILITY



Enhanced Monitoring of Surrounding Areas

Once interfaced with the Satellite Compass, AIS receiver/transponder and other interface options, NavNet 3D enables enhanced monitoring of vessel traffic around your craft. This would boost your situational awareness, which ultimately leads to safer boating.

Enhanced Radar-Chart Overlay, ARPA Target Tracking and Echo Trail

When interfaced with the highly accurate heading data from the SC-30/50/110 Satellite Compass, NavNet 3D radar-chart overlay, ARPA target tracking and echo trail functions can be greatly enhanced.

Even when your craft turns around quickly or run into rough sea conditions, NavNet 3D with the SC-30/50/110 presents clear and stable radar echo trails, constant ARPA target tracking and spot-on radar-chart overlay.

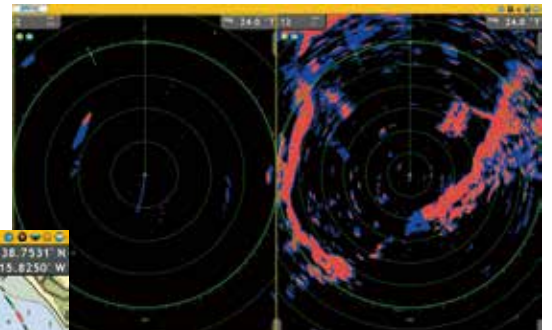

Radar echo trail



Radar-Chart overlay





AIS Target Tracking

When FURUNO AIS FA-30/50/150 is interfaced with NavNet 3D, the AIS information is integrated into the NavNet 3D network to facilitate enhanced monitoring of the surrounding area from any station. Up to 100 AIS targets can be tracked and displayed with five different symbols to indicate their status. Detailed information about a specific target can be viewed in a pop-up AIS data window when you select the target with the cursor.

What is AIS?

The Automatic Identification System (AIS) improves the safety level of boating by exchanging information about the status of your ship with other AIS-equipped craft nearby. The system utilizes VHF broadcasts to handle information about the surrounding area, such as other craft and buoys and other aids-to-navigation.

The AIS data includes target position, course and speed over ground, allowing you to foresee the course changes of particular targets. AIS targets are constantly visible even when they are shrouded in fog or darkness, or hidden behind headlands, river bends or other obstructions.

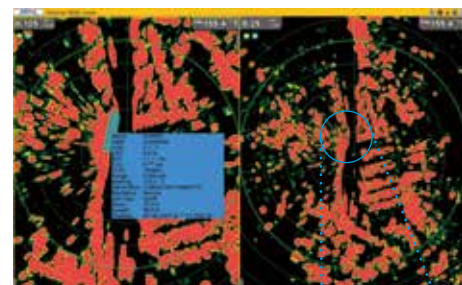
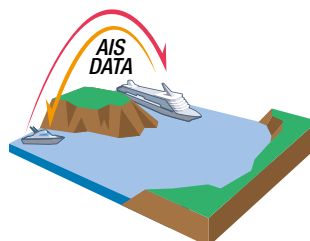

Information to be Exchanged

- | | |
|---|---|
| <p>Dynamic Data</p> <ul style="list-style-type: none"> ▶ Ship's Position ▶ Coordinated Universal Time (UTC) ▶ Course over Ground (COG) ▶ Speed over Ground (SOG) ▶ Rate of Turn (ROT) ▶ Heading ▶ Navigation Status <p>Static Data</p> <ul style="list-style-type: none"> ▶ MMSI (Maritime Mobile Service Identity) ▶ IMO Number | <ul style="list-style-type: none"> ▶ Ship's Name ▶ Type of Ship ▶ Call Sign ▶ Length and Beam ▶ Location of Position-Fixing Antenna on the Ship <p>Voyage-Related Data</p> <ul style="list-style-type: none"> ▶ Ship's Draft ▶ Hazardous Cargo ▶ Destination and Estimated Time of Arrival (ETA) <p>Safety-Related Messages</p> |
|---|---|



Heaving Compensation with Satellite Compass SC-30/50/110

Unstable fish finder presentation caused by craft's heaving motion will no longer be an issue. FURUNO's Satellite Compass SC-30/50/110 detects your craft's heaving motion and transfers the data to the networked fish finder. The network fish finder, in its turn, will correct the echo distortion to deliver a stable underwater presentation to your network.

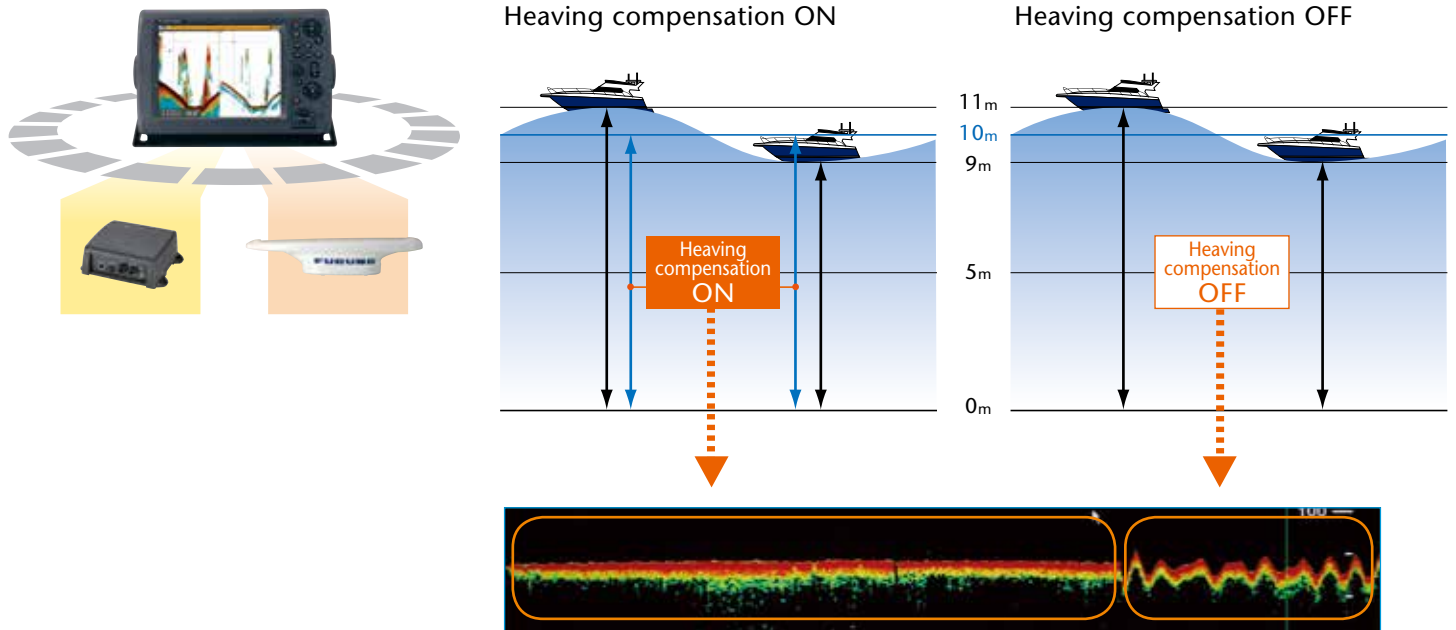

FAX-30

Turn your NavNet 3D display into Weather fax and NAVTEX receiver by connecting the FAX-30 into the NavNet 3D network.

- ▶ Up to 12 satellite photos can be stored in memory
- ▶ Programmed with all currently available facsimile stations: up to 320 channels storable
- ▶ Presentation in monotone, 16-gradation gray scale or color (three patterns of color presentation are available)
- ▶ Built-in NAVTEX receiver (490 kHz and 518 kHz) can store up to 130 messages



WWW.NAVNET.COM



Whenever you require any information about NavNet 3D, just visit our web site, solely dedicated to the current and would-be users of NavNet 3D, www.NavNet.com. At NavNet.com, you can access the contents with in-depth product information from various angles, including a NavNet 3D demonstration film, introduction to the product, product specifications, online tutorial, system suggestions and online system builder and much more! Also, you can find answers to questions you may have in our solution database (FAQs) on the web site.



Chart update and software update available for your NavNet 3D

Make sure that your NavNet 3D system has the latest versions of chart data and Operating System software in order to maximize your boating experience with NavNet 3D. As a valued NavNet 3D user, you can check your system to see if you have the latest version of chart data and Operation System software on your NavNet 3D from "My NavNet" within www.navnet.com. If you find that the newer versions of the Operating System software are available, you can update your system software from "My NavNet" absolutely free of charge! Also, if the newer version of the chart data of your region is available, you can purchase the unlock code for the updated chart data from this page! Go register now and create your own account with "My NavNet" at <https://secure.navnet.com/mynavnet/>.



"My NavNet" gives you a number of other premium benefits. These include receiving breaking news on NavNet 3D, obtaining a variety of support, and much more. In order to register with "My NavNet", you will need to have registration number imprinted on the Registration Sheet you can find in the product package of your MFDs. Also, you can register your NavNet 3D family products (serial number of a product is required for registration).

You can register the following products with "My NavNet" in order for you to benefit from the total package of unbeatable support:

MFDBB, MFD12, MFD8, DRS2D, DRS4D, DRS4A, DRS6A, DRS12A, DRS25A, DCU12, DFF1, DFF3, BBDS1, SC-30, FI-50, FA-30, FA-50, GP-330B, GP-33, RD-33, NAVipilot 700 Series, PG-700, WS-200, DST-800.

When placing a purchase order for the unlock code, you will need to enter your NavNet 3D System ID, which can be obtained from the menu "My NavNet" in your MFD.





SPECIFICATIONS

Multi Function Display	MFD8 MFD12 MFD8B
Network Fish Finder	DFF1 DFF3 BBDS1
GPS/WAAS Receiver Antenna	GP-320B GP-330B
Network Weather Facsimile Receiver	FAX-30
LCD Display	MU-150HD MU-190HD
Display Control Unit	DCU12
NavNet 3D Radar Sensor	DRS2D DRS4D DRS4A DRS6A DRS12A DRS25A



Multi Function Display		MFD8	MFD12
DISPLAY UNIT			
Type		8.4" Color TFT LCD	12.1" Color TFT LCD
Screen Size		8.4", 170.4 x 127.8 mm	12.1", 246.0 x 184.5 mm
Screen Resolution		VGA 640 x 480 pixels	SVGA 800 x 600 pixels
Screen Brightness		700 cd (typical)	1100 cd (typical)
Display Colors		Chart Plotter/Menu: 65,536 colors Fish Finder: 64 colors Radar: 32 Colors	
Language		English (US & UK), French, Spanish, German, Italian, Portuguese, Swedish, Danish, Norwegian, Finnish, Dutch, Japanese	
PLOTTER CHARACTERISTICS			
Memory Capacity		Up to 10,000 points for ship's tracks, 2000 user points, 200 planned routes (100 points per route)	
Display Modes		Course plot, NAV data, Navigational instrument display, Engine monitoring display	
Latitude Limit		Between 85°N and 85°S	
Alarms		Anchor Watch, XTE, Proximity, Depth, Temperature, Speed, Trip Log, Countdown, Timer, Alarm Clock	
RADAR CHARACTERISTICS			
Display Modes		Head-up, Course-up*, North-up*, Relative Motion, True Motion** (*Heading input required **Heading and speed inputs required)	
Echo Trail		Interval: 15 s, 30 s, 1 min, 3 mins, 6 mins, 15 mins, 30 mins and continuous	
INTERFACE			
LAN		1 Port, 100 BASE-TX	
NMEA0183		3 Ports for Input/Output	
Interface (NMEA0183)	Input:	DBK, DBS, DBT, DPT, DTM, GGA, GLL, GNS, HDG, HDM, HDT, MDA, MTW, MWV, RMA, RMC, ROT, VDM, VHW, VTC, VWR, VWT, ZDA, FURUNO Proprietary Sentences are used for pitch, roll and heave data input from FURUNO Satellite Compass SC series.	
	Output:	AAM, APB, BOD, BWC, BWR, DBT, DPT, DTM, GGA, GLL, GNS, GTD, HDG, HDT, MTW, MWV, RMA, RMB, RMC, ROT, VHW, VTC, WPL, XTE, ZDA, ZTG, FURUNO Proprietary Sentence is used for true heading, pitch and roll data output.	
CAN bus/NMEA2000®		1 Port	
Interface (CAN bus/NMEA2000®)	Input:	059392, 059904, 060928, 126208, 126992, 126996, 127245, 127250, 127251, 127257, 127258, 127488, 127489, 128259, 128267, 129025, 129026, 129029, 129033, 129044, 129538, 129540, 129808, 130306, 130310, 130311, 130577	
	Output:	059392, 059904, 060928, 126208, 126464, 126992, 126996, 127245, 127250, 127251, 127257, 127258, 128275, 128259, 128267, 129025, 129026, 129029, 129033, 129283, 129284, 130306, 130310, 130311	
USB Port		1 Port (USB 1.1)	
Video Output		1 Port (DVI-D VGA)	1 Port (DVI-D SVGA)
Video Input		2 Ports (NTSC/PAL)	
Line Out		1 Port	
SD Card Slot		2 Slots	
Variable Line Level Stereo Output		N/A	
ENVIRONMENT			
Temperature (IEC60945)	Display Unit	-15°C to +55°C	
	Processor Unit	N/A	
	Control Unit	N/A	
Waterproofing	Display Unit	IP56 (IEC60529)	
	Processor Unit	N/A	
	Control Unit	N/A	
POWER SUPPLY			
		12-24 VDC	
		29 W/73 W (with DRS2D)/77 W (DRS4D)/104 W (with DRS4A)/131 W (with DRS6A)/143 W (with DRS12A)/174 W (with DRS25A)	41 W/86 W (with DRS2D)/91 W (DRS4D)/132 W (with DRS4A)/144 W (with DRS6A)/159 W (with DRS12A)/186 W (with DRS25A)
		100/110/220/230 VAC with optional rectifier RU-1746B-2/PR-62/RU-3423	

* With regard to the NMEA 2000 PGN specifications, please refer to P.37.

Multi Function Display (Table-top Mount) MFD8

4.7 kg 10.4 lb

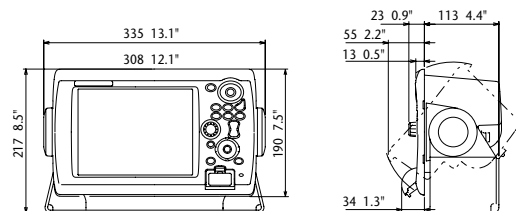

Multi Function Display (Flush Mount) MFD8

3.9 kg 8.6 lb

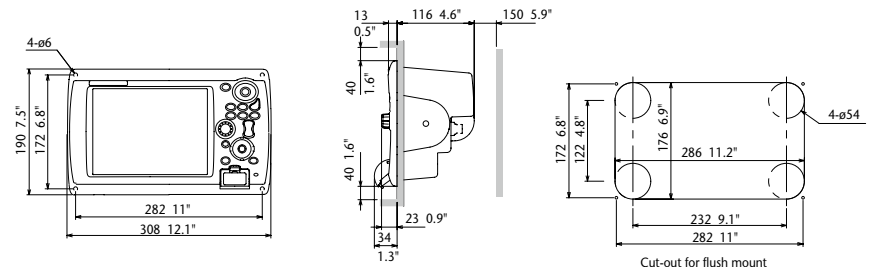

Multi Function Display (Table-top Mount) MFD12

6.8 kg 15.0 lb

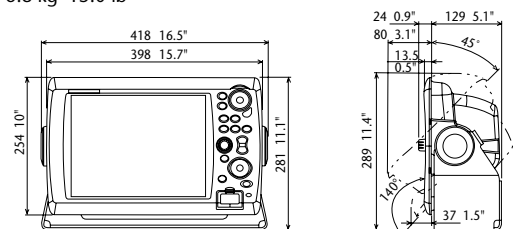

Multi Function Display (Flush Mount) MFD12

5.4 kg 11.9 lb

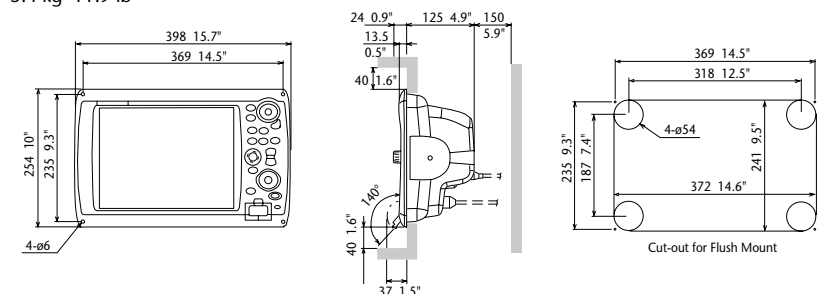



Multi Function Display		MFDBB
DISPLAY UNIT		
Type	Custom monitor of your choice	
Screen Size	Please refer to the specifications of DCU12, MU-120C/155C/170C	
Screen Resolution	SVGA 800 x 600 pixels, XGA 1024 x 768 pixels or SXGA 1280 x 1024 pixels	
Screen Brightness	Please refer to the specifications of DCU12, MU-120C/155C/170C	
Display Colors	Chart Plotter/Menu: 262,144 colors Fish Finder: 64 colors Radar: 256 colors	
Language	English (US & UK), French, Spanish, German, Italian, Portuguese, Swedish, Danish, Norwegian, Finnish, Dutch, Japanese	
PLOTTER CHARACTERISTICS		
Memory Capacity	Up to 10,000 points for ship's tracks, 2000 user points, 200 planned routes (100 points per route)	
Display Modes	Course plot, NAV data, Navigational instrument display, Engine monitoring display	
Latitude Limit	Between 85°N and 85°S	
Alarms	Anchor Watch, XTE, Proximity, Depth, Temperature, Speed, Trip Log, Countdown, Timer, Alarm Clock	
RADAR CHARACTERISTICS		
Display Modes	Head-up, Course-up*, North-up*, Relative Motion, True Motion** (*Heading input required **Heading and speed inputs required)	
Echo Trail	Interval: 15 s, 30 s, 1 min, 3 mins, 6 mins, 15 mins, 30 mins and continuous	
INTERFACE		
LAN	4-Port Hub is included, 100 BASE-TX	
NMEA0183	3 Ports for Input/Output	
Interface (NMEA0183)	Input:	DBK, DBS, DBT, DPT, DTM, GGA, GLL, GNS, HDG, HDM, HDT, MDA, MTW, MWV, RMA, RMC, ROT, VDM, VHW, VTC, VWR, VWT, ZDA, FURUNO Proprietary Sentences are used for pitch, roll and heave data input from FURUNO Satellite Compass SC series.
	Output:	AAM, APB, BOD, BWC, BWR, DBT, DPT, DTM, GGA, GLL, GNS, GTD, HDG, HDT, MTW, MWV, RMA, RMB, RMC, ROT, VHW, VTC, WPL, XTE, ZDA, ZTG, FURUNO Proprietary Sentence is used for true heading, pitch and roll data output.
CAN bus/NMEA2000®	1 Port	
Interface (CAN bus/NMEA2000®)	Input:	059392, 059904, 060928, 126208, 126992, 126996, 127245, 127250, 127251, 127257, 127258, 127488, 127489, 128259, 128267, 129025, 129026, 129029, 129033, 129044, 129538, 129540, 129808, 130306, 130310, 130311, 130577
	Output:	059392, 059904, 060928, 126208, 126464, 126992, 126996, 127245, 127250, 127251, 127257, 127258, 128275, 128259, 128267, 129025, 129026, 129029, 129033, 129283, 129284, 130306, 130310, 130311
USB Port	2 Ports (USB 2.0)	
Video Output	2 Ports (DVI-D)	
Video Input	4 Ports (NTSC/PAL)	
Line Out	1 Port	
SD Card Slot	2 Slots	
Variable Line Level Stereo Output	1 Port	
ENVIRONMENT		
Temperature (IEC60945)	Display Unit	-15°C to +55°C (DCU12)
	Processor Unit	0°C to +45°C
	Control Unit	-15°C to +55°C
Waterproofing	Display Unit	IP56 (DCU12 when flush mounted) IEC60529
	Processor Unit	IP20
	Control Unit	IP56 (MCU-001 when flush mounted) IEC60529
POWER SUPPLY		
12-24 VDC		
104 W/149 W (with DRS2D)/154 W (DRS4D)/195 W (with DRS4A)/ 207 W (with DRS6A)/222 W (with DRS12A)/249 W (with DRS25A)		
100/110/220/230 VAC with optional rectifier RU-1746B-2		

* With regard to the NMEA 2000 PGN specifications, please refer to P.37.

Multi Function Display MFDBB
BlackBox Processor Unit MPU-001
 15.0 kg 33.1 lb

BlackBox
Control Unit MCU-001
 1.0 kg 2.2 lb

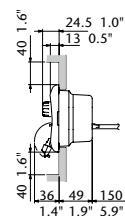
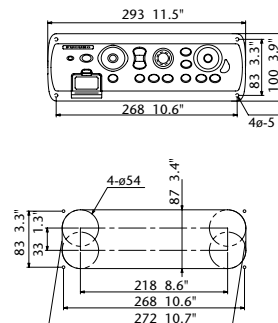
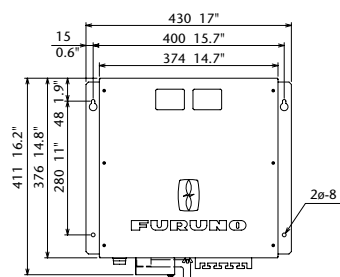



Network Fish Finder		DFF1/BBDS1	DFF3
TRANSCEIVER & DISPLAY			
Display Modes	Single (50 or 200 kHz), Dual (50 and 200 kHz), Bottom-lock, Bottom-Zoom, Bottom Discrimination, Marker Zoom, A-Scope	Single (High or Low frequency), Dual (Both High and Low frequencies), Bottom-lock, Bottom-Zoom, Bottom Discrimination, Marker Zoom, A-Scope	The synthesized transducer works with dual frequencies between 28 and 200 kHz
Frequency	Dual frequency 50 kHz and 200 kHz		
Output Power	600 W/1 kW		1, 2 or 3 kW
Range Scale	Any range customized between 2 and 1,200 m		
Range Phasing	Up to 2,400 m (8,000 ft, 1,300 fa)		Up to 2,400 m (8,000 ft, 1,300 fa)
ENVIRONMENT			
Temperature	-15°C to +55°C		
Water Proofing	IEC 60529 IP20		
POWER SUPPLY			
		12 W	30 W
TRANSDUCERS (Specify when ordering)			
	600 W 50/200 kHz: 520-5PSD (Plastic, thru-hull), 520-5MSD (Bronze, thru-hull), 520-5PWD (Plastic, transom), 525ST-MSD (Bronze, thru-hull with speed/temp sensor), 525ST-PWD (Plastic, transom, with speed/temp sensor) 1kW (Optional Matching box, MB-1100 may be required) 50 kHz*: 50B-6, 50B-6B, 50B-9B 200 kHz*: 200B-5S, 50/200 kHz: 50/200-1T	28 kHz 38 kHz 50 kHz 68 kHz 82 kHz 88 kHz 107 kHz 150 kHz 200 kHz 50/200 kHz	28F-8, 28F-18, 28BL-6HR, 28F-24H, 28BL-12HR 38BL-9HR, 38BL-15HR 50B-6/6B, 50B-9B, 50B-12, 50BL-12HR, 50F-24H, 50BL-24HR 68F-8H, 68F-30H 82B-35R 88B-8, 88B-10, 88F-126H 100B-10R 150B-12H 200B-5S, 200B-8/8B, 200B-12H 50/200-1ST, 50/200-1T
		* DFF1 only	



GPS/WAAS Receiver Antenna		
	GP-320B	GP-330B
RECEIVER CHARACTERISTICS		
Receiver Type	Twelve discrete channels, C/A code, all-in-view, WAAS	
Receiving Frequency	L1 (1575.42 MHz)	
Time to First Fix	12 s (warm start)	90 s (cold start)
Tracking Velocity	999 kt	
Geodetic Systems	WGS-84, NAD-27 and others	
Accuracy	10 m (GPS) 3 m (WAAS)	
ENVIRONMENT (IEC 60945 test method)		
Temperature	-25°C to +70°C	-25°C to +55°C
Waterproofing	IEC 60529 IPX6	IEC 60529 IP56
POWER SUPPLY		
	12-24 VDC	12 VDC
	1.3 W	1.8 W

Network Weather Facsimile Receiver	
FAX-30	
TRANSCEIVER CHARACTERISTICS	
Frequency Range	80 kHz to 160 kHz, 2 MHz to 25 MHz, 490 kHz, 518 kHz (NAVTEX)
Class of Emmission	F3C, J3C, F1B (NAVTEX)
Receiving System	Double superheterodyne
Storage	Fax: 12 pictures NAVTEX: 130 messages
ENVIRONMENT (IEC 60945 test method)	
Temperature	-15°C to +55°C
Waterproofing	IEC 60529 IPX2
POWER SUPPLY	
	12-24 VDC
	12 W

Network Fish Finder DFF1

1.3 kg 2.9 lb

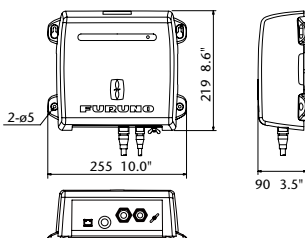

Network Fish Finder DFF3

3.8 kg 8.4 lb

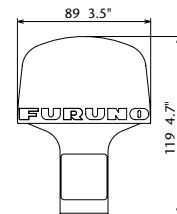
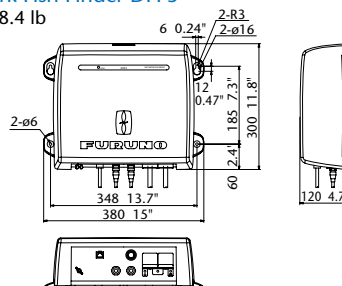

GPS/WAAS Receiver Antenna GP-320B

0.8 kg 1.8 lb

10 m cable attached

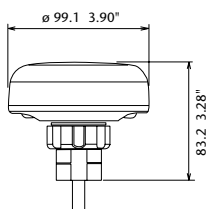

GPS/WAAS Receiver Antenna GP-330B

Weight: TBD

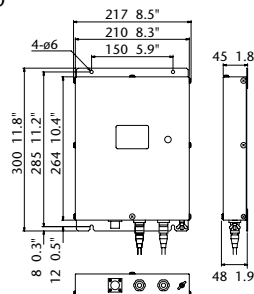

Network Weather Facsimile Receiver FAX-30

2.0 kg 4.4 lb

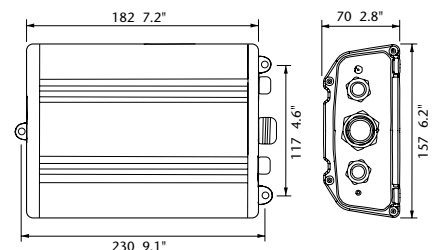



Display Control Unit		DCU12
DISPLAY UNIT		
Screen Size	12.1 inches, 246.0 x 184.5 mm	
Resolution	SVGA 800 x 600 pixels	
Contrast Ratio	600: 1	
Viewing Angle	Vertical	+45 to -55°
	Horizontal	left 70° to right 70°
Brightness	1100 cd	
INTERFACE		
DVI input	1 port, DVI-D	
Composite (RCA) input	NA	
ENVIRONMENT (IEC 60945 test method)		
Temperature	-15°C to +55°C	
Waterproofing	IP56 (when flush-mounted)	
POWER SUPPLY		
	12-24 VDC	

N.B. DCU12 is a display option for MFDBB.

Display Control Unit (Table-top Mount) DCU12

5.7 kg 12.6 lb

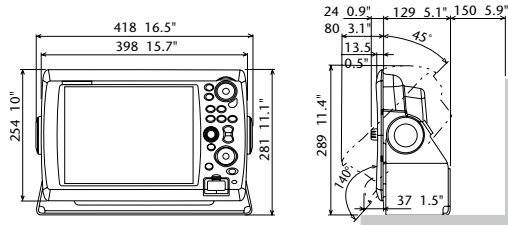

Display Control Unit (Flush Mount) DCU12

5.4 kg 11.9 lb

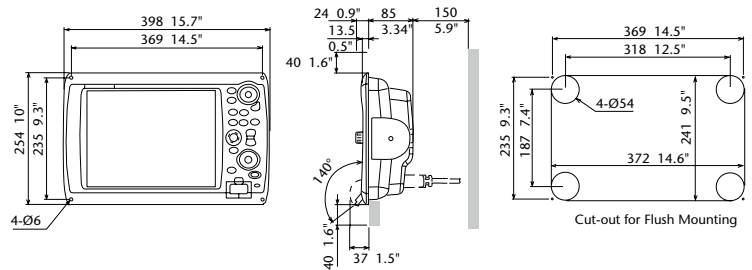

LCD Display	MU-150HD	MU-190HD
DISPLAY UNIT		
Screen Size	15 inches, 304.1 x 228.1 mm	17 inches, 338.0 x 270.0 mm
Resolution	XGA 1024 x 768 pixels	SXGA 1280 x 1024 pixels
Contrast Ratio	600: 1	900: 1
Viewing Angle	Vertical	up 80° to down 80° or more left 80° to right 80° or more
	Horizontal	
Brightness	Max. 1000 cd/m ² , Min. 0.2 cd/m ² or under	
INTERFACE		
Analog RGB	1 port, D-SUB/15 pins	
DVI	2 ports, DVI-D	
Composite (RCA) input	3 ports, NTSC/PAL	
ENVIRONMENT (IEC 60945 test method)		
Temperature	-15°C to +55°C	
Waterproofing	IP56 (CFR46 Front Panel), IP22 (Back Panel)	
POWER SUPPLY		
	12-24 VDC, 4.5 - 2.2 A	12-24 VDC, 8.4 - 3.9 A

MU-150HD Flush Mount

5.4 kg 11.9 lb

MU-150HD Table-top Mount (option)

7.4 kg 16.3 lb

MU-190HD Table-top Mount (option)

11 kg 24.3 lb

MU-190HD Flush Mount

8.2 kg 18.1 lb

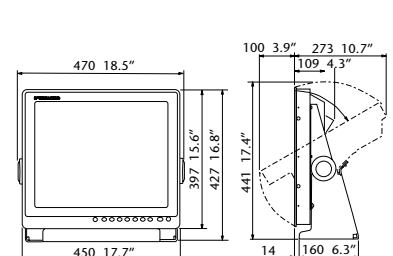
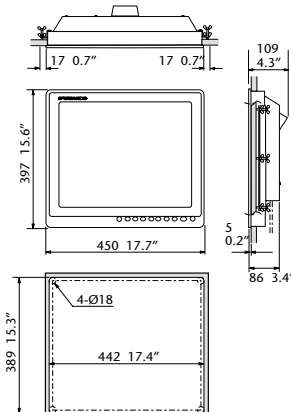
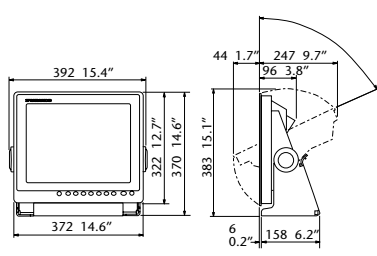
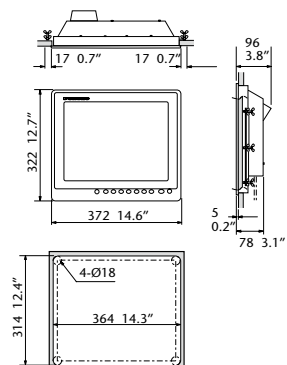



NavNet 3D Radar Sensor		DRS2D	DRS4D	DRS4A
ANTENNA				
Peak Output Power		2.2 kW	4 kW	4 kW
Type		19" Radome	24" Radome	3.5' Open
RF TRANSCEIVER				
Frequency		9410 ± 30 MHz		
Pulseshift & PRR		0.08 µs/3000 Hz (0.0625 to 0.75 nm) 0.15 µs/3000 Hz (1 to 1.5 nm) 0.3 µs/1500 Hz (2 nm) 0.5 µs/1000 Hz (3 to 4 nm) 0.7 µs/600 Hz (6 to 8 nm) 0.8 µs/600 Hz (12 to 24 nm)	0.08 µs/3000 Hz (0.0625 to 0.75 nm) 0.15 µs/3000 Hz (1 to 1.5 nm) 0.3 µs/1500 Hz (2 nm) 0.5 µs/1000 Hz (3 to 4 nm) 0.7 µs/600 Hz (6 to 8 nm) 0.8 µs/600 Hz (12 to 36 nm)	0.08 µs/3000 Hz (0.0625 to 0.75 nm) 0.15 µs/3000 Hz (1 to 1.5 nm) 0.3 µs/1500 Hz (2 nm) 0.5 µs/1000 Hz (3 to 4 nm) 0.7 µs/600 Hz (6 to 8 nm) 0.8 µs/600 Hz (12 to 48 nm)
Beam Width	Horizontal	5.2°	4.0°	2.3°
	Vertical	25°	25°	22°
Range Scales		0.0625 to 24 nm	0.0625 to 36 nm	0.0625 to 48 nm
Antenna Rotation Speed		24/36/48 rpm		
Wind Load		Relative Wind 70 kt		
ENVIRONMENT				
Temperature		-30°C to + 55°C		
Waterproofing		IP26		
Power Amp Unit	MFD8	Not required (Power Provided by the Display Unit)		PSU-012 (75 W)
	MFD12	Not required (Power Provided by the Display Unit)		
	MFD8B	Not Required (Power Provided by the BB Processor)		

19" Radome Radar Sensor DRS2D

6.5 kg 14.3 lb

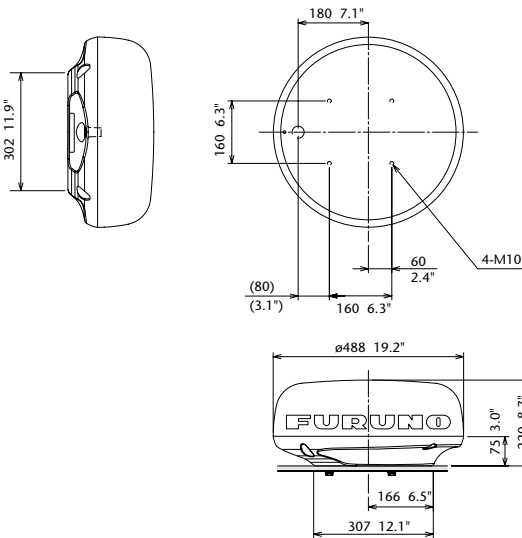

3.5' Open Radar Sensor DRS4A

25 kg 55.1 lb

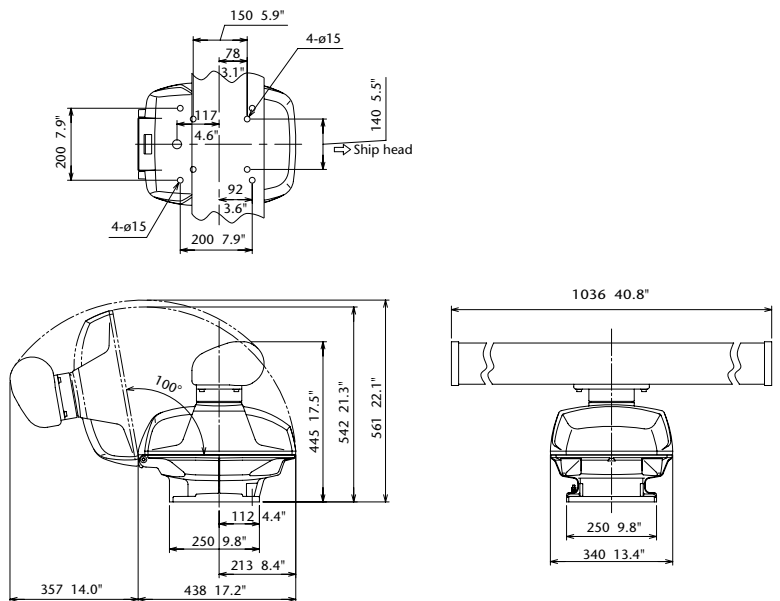

24" Radome Radar Sensor DRS4D

7.5 kg 16.5 lb

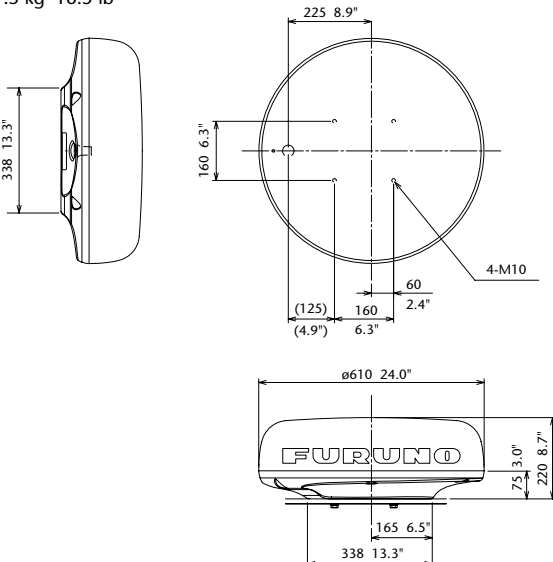



NavNet 3D Radar Sensor		DRS6A	DRS12A	DRS25A
ANTENNA				
Peak Output Power		6 kW	12 kW	25 kW
Type		4' Open	4'/6' Open	4'/6' Open
RF TRANSCEIVER				
Frequency		9410 ± 30 MHz		
Pulselength & PRR		0.08 μs/3000 Hz (0.0625 to 0.75 nm) 0.15 μs/3000 Hz (1 to 1.5 nm) 0.3 μs/1500 Hz (2 nm) 0.5 μs/1000 Hz (3 to 4 nm) 0.7 μs/600 Hz (6 to 8 nm) 0.8 μs/600 Hz (12 to 64 nm)	0.08 μs/3000 Hz (0.0625 to 0.75 nm) 0.15 μs/3000 Hz (1 to 1.5 nm) 0.3 μs/1500 Hz (2 nm) 0.5 μs/1000 Hz (3 to 4 nm) 0.7 μs/600 Hz (6 to 8 nm) 0.8 μs/600 Hz (12 to 64 nm) 0.8 μs/550 Hz (72 nm)	0.08 μs/3000 Hz (0.0625 to 0.75 nm) 0.15 μs/3000 Hz (1 to 1.5 nm) 0.3 μs/1500 Hz (2 nm) 0.5 μs/1000 Hz (3 to 4 nm) 0.7 μs/600 Hz (6 to 8 nm) 0.8 μs/600 Hz (12 to 64 nm) 0.8 μs/550 Hz (72 to 96 nm)
Beam Width	Horizontal	1.9°	1.9°/1.4°	1.9°/1.4°
	Vertical	22°	22°/22°	22°/22°
Range Scales		0.0625 to 64 nm	0.0625 to 72 nm	0.0625 to 96 nm
Antenna Rotation Speed		24/36/48 rpm		
Wind Load		Relative Wind 70 kt		
ENVIRONMENT				
Temperature		-30°C to + 55°C		
Waterproofing		IP26		
Power Amp Unit	MFD8	PSU-012 (102 W)	PSU-012 (118 W)	PSU-013 (145 W)
	MFD12	Not required (Power Provided by the Display Unit)	PSU-012 (118 W)	PSU-013 (145 W)
	MFD8B	Not Required (Power Provided by the BB Processor)		PSU-013 (145 W)

4' Open Radar Sensor DRS6A/12A/25A
25 kg 55.1 lb

6' Open Radar Sensor DRS12A
26 kg 57.3 lb

6' Open Radar Sensor DRS25A
28 kg 61.7 lb

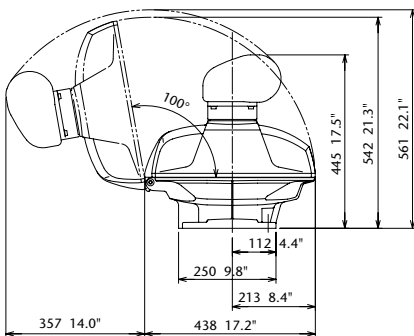
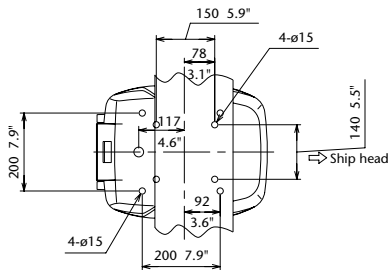

DRS6A/12A/25A (XN12A): 1255 49.4"
DRS12A/25A (XN13A): 1795 70.7"

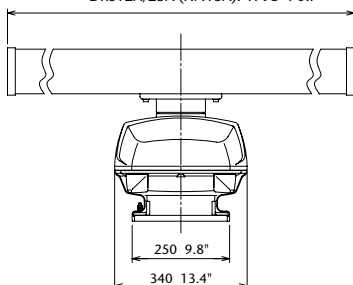

NMEA 2000 Input

PGN	Details
059392	ISO Acknowledgement
059904	ISO Request
060928	ISO Address Claim
126208	NMEA - Request group function NMEA - Command group function NMEA - Acknowledge group function
126992	System Time
126996	Product Information
127245	Rudder
127250	Vessel Heading
127251	Rate of Turn
127257	Attitude
127258	Magnetic Variation
127488	Engine parameters, Rapid Update
127489	Engine Parameters, Dynamic
128259	Speed
128267	Water Depth
129025	Position, Rapid Update
129026	COG & SOG, Rapid Update
129029	GNSS Position Data
129033	Time & Date
129044	Datum
129538	GNSS Control Status
129540	GNSS Satellites in View
130306	Wind Data
130310	Environmental Parameters
130311	Environmental Parameters
130577	Direction Data

Output

PGN	Details
059392	ISO Acknowledgement
059904	ISO Request
060928	ISO Address Claim
126208	NMEA - Request group function NMEA - Command group function NMEA - Acknowledge group function
126464	PGN List
126992	System Time
126996	Product Information
127245	Rudder
127250	Vessel Heading
127251	Rate of Turn
127257	Attitude
127258	Magnetic Variation
128275	Distance Log
128259	Speed
128267	Water Depth
129025	Position, Rapid Update
129026	COG & SOG, Rapid Update
129029	GNSS Position Data
129033	Time & Date
129283	Cross Track Error
129284	Navigation Data
130306	Wind Data
130310	Environmental Parameters
130311	Environmental Parameters

NOTE



www.furuno.com

All brand and product names are registered trademarks,
trademarks or service marks of their respective holders.
Alpha blending technology is used for transparency effects.
SPECIFICATIONS SUBJECT TO CHANGE WITHOUT NOTICE

FURUNO ELECTRIC CO., LTD.

Nishinomiya, Hyogo, Japan
www.furuno.com

FURUNO U.S.A., INC.

Camas, Washington, U.S.A.
www.furunousa.com

FURUNO (UK) LIMITED

Havant, Hampshire, U.K.
www.furuno.co.uk

FURUNO FRANCE S.A.S.

Bordeaux-Mérignac, France
www.furuno.fr

FURUNO ITALIA S.R.L.

Gatteo Mare, Italy
www.furuno.it

FURUNO ESPAÑA S.A.

Madrid, Spain
www.furuno.es

FURUNO DANMARK A/S

Hvidovre, Denmark
www.furuno.dk

FURUNO NORGE A/S

Ålesund, Norway
www.furuno.no

FURUNO SVERIGE AB

Västra Frölunda, Sweden
www.furuno.se

FURUNO FINLAND OY

Espoo, Finland
www.furuno.fi

FURUNO POLSKA Sp. z o.o.

Gdynia, Poland
www.furuno.pl

FURUNO EURUS LLC

St. Petersburg, Russian Federation
www.furuno.ru

FURUNO SINGAPORE PTE LTD

Singapore
www.furuno.sg

FURUNO DEUTSCHLAND GmbH

Rellingen, Germany
www.furuno.de

FURUNO HELLAS S.A.

Piraeus, Greece
www.furuno.gr

FURUNO (CYPRUS) LTD

Limassol, Cyprus
www.furuno.com.cy

FURUNO CHINA CO., LTD.

Shanghai, China
www.furuno.com/cn

FURUNO SHANGHAI CO., LTD.

Shanghai, China
www.furuno.com/cn